

KALLISTA®

One™ by KALLISTA Pull-Down Kitchen Faucet P25200-00

Features

- A selection of products within this collection is in stock and ready to ship. Please visit kallista.com/resources/#ReadyToShip for the complete list of Ready-to-Ship products and finishes
- High-quality solid-brass construction for durability and reliability
- Spout reach is 9-9/16" (243 mm)
- 1.8 gpm (6.8 lpm) maximum flow rate
- Two-hole installation
- 360-degree swing spout
- Sprayhead provides both laminar and spray functions at the touch of a button
- Sink strainer with tailpiece sold separately

Recommended Products/Accessories

- L20857-00 36" Apron-front Kitchen Sink
- P34000-00 Sink strainer
- P25202-LV Deck-Mount Bridge Kitchen Faucet, Lever Handles
- P25215-00 Soap/Lotion Dispenser



ADA

Codes/Standards









ASME A112.18.1/CSA B125.1
DOE - Energy Policy Act 1992
California Energy Commission (CEC)
ADA
ICC/ANSI A117.1

KALLISTA® Five-Year Limited Warranty

See website for detailed warranty information.

Available Colors/Finishes

Color tiles intended for reference only.

Color	Code	Description
	AD	Nickel Silver
	CP	Polished Chrome
	AG	Brushed Nickel
	BL	Matte Black
	ULB	Unlacquered Brass
	BGP	Brushed Graphite
	PGP	Polished Graphite
	2MB	Brushed Moderne Brass

1-888-4-KALLISTA (1-888-452-5547)

Kallista reserves the right to make revisions without notice to product specifications.

For the most current Specification Sheet, go to www.kallista.com.

3-1-2026 21:06 - US

KALLISTA

One™ by KALLISTA
Pull-Down Kitchen Faucet
P25200-00

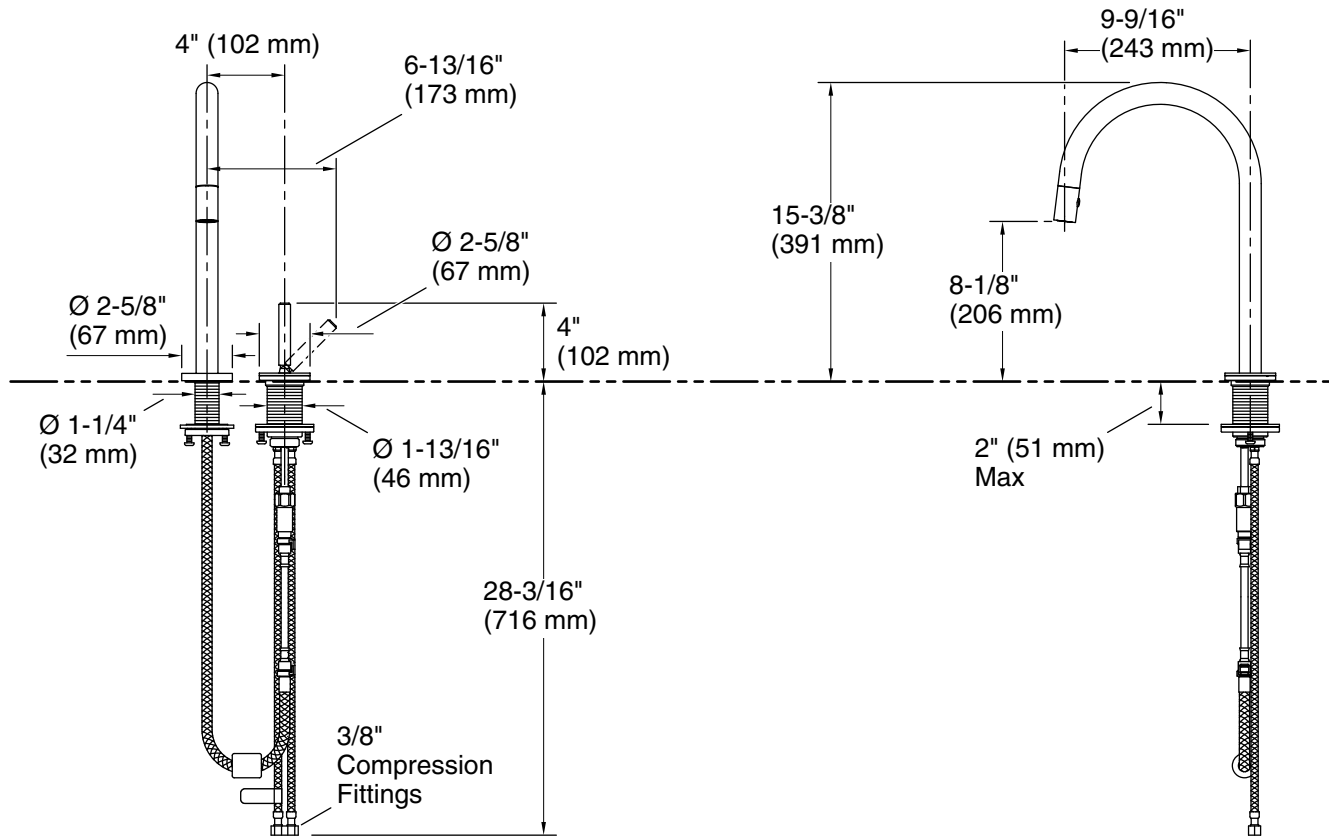

Technical Information

All product dimensions are nominal.

Faucet flow rate: 1.8 gal/min (6.8 l/min)

Spout:

Spout reach: 9-9/16" (243 mm)

Notes

Install this product according to the installation instructions.

ADA compliant when installed to the specific requirements of these regulations.

1-888-4-KALLISTA (1-888-452-5547)

Kallista reserves the right to make revisions without notice to product specifications.

For the most current Specification Sheet, go to www.kallista.com.

3-1-2026 21:06 - US