

KALLISTA®

One™ by KALLISTA
Single-control sink faucet, low spout
P26610-00

Features

- A selection of products within this collection is in stock and ready to ship. Please visit kallista.com/readytoship for the complete list of Ready-to-Ship products and finishes
- High-quality solid-brass construction for durability and reliability
- 5" (127 mm) spout reach
- 6-1/16" (154 mm) faucet height
- Includes metal pop-up drain with 1-1/4" metal tailpiece
- Single-hole installation
- 1.2 gpm (4.5 lpm) maximum flow rate

Recommended Products/Accessories

P74234-WO Under-mount Sink, Soft Rectangle with Overflow, Glazed
P34401-00 Towel Bar, 24"
P34407-00 Disc Hook



ADA **CSA B651** **OBC**

Codes/Standards







ASME A112.18.1/CSA B125.1
NSF/ANSI/CAN 61
NSF/ANSI/CAN 372
DOE - Energy Policy Act 1992
EPA WaterSense®
California Energy Commission (CEC)
ADA
ICC/ANSI A117.1
CSA B651
OBC

KALLISTA® Five-Year Limited Warranty

See website for detailed warranty information.

Available Colors/Finishes

Color tiles intended for reference only.

Color	Code	Description
	CP	Polished Chrome
	BL	Matte Black
	ULB	Unlacquered Brass
	BAF	Brushed French Gold
	BN	Brushed Nickel
	SN	Polished Nickel
	2MB	Brushed Moderne Brass

1-888-4-KALLISTA (1-888-452-5547)

Kallista reserves the right to make revisions without notice to product specifications.

For the most current Specification Sheet, go to www.kallista.com.

2-20-2025 21:46 - US

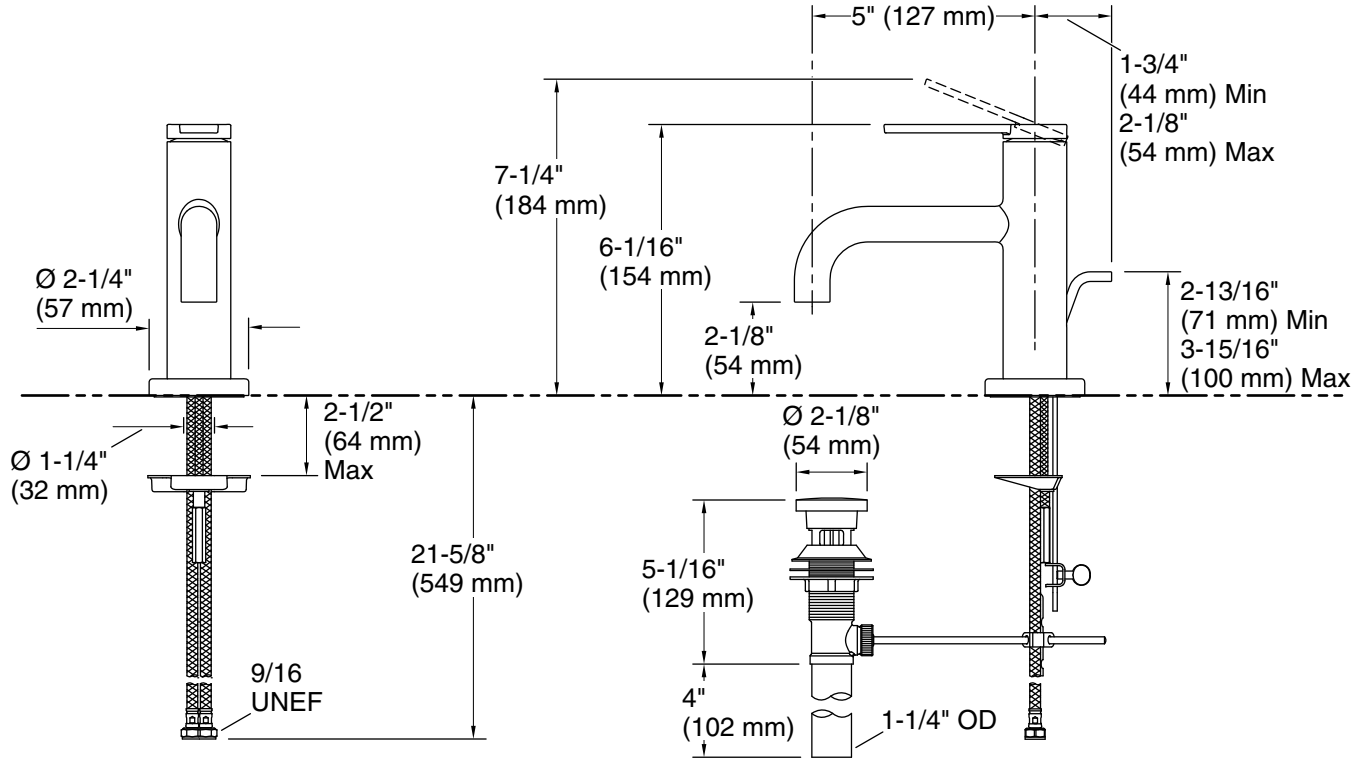

Technical Information

All product dimensions are nominal.

Faucet flow rate: 1.2 gal/min (4.5 l/min)

Drain included: Yes

Drain with overflow: Yes

Spout:

Spout reach: 5-1/2" (140 mm)

Notes

Install this product according to the installation instructions.

ADA, OBC, CSA B651 compliant when installed to the specific requirements of these regulations.