

Features

- High-quality solid-brass construction for durability and reliability
- Wall-mount installation
- 22" (559 mm) reach capability

Recommended Products/Accessories

- P25001-00 Deck-Mount Bridge Faucet, Lever Handles
- P25000-00 Pull-Down Kitchen Faucet
- L20311-00 24" Butler Sink
- P30801-00 4" cabinet pull



Codes/Standards









- ASME A112.18.1/CSA B125.1
- NSF/ANSI/CAN 61
- NSF/ANSI/CAN 372

KALLISTA® Five-Year Limited Warranty

See website for detailed warranty information.

Available Colors/Finishes

Color tiles intended for reference only.

| Color | Code | Description |
|---|------|-----------------------|
|  | AD | Nickel Silver |
|  | CP | Polished Chrome |
|  | AG | Brushed Nickel |
|  | ULB | Unlacquered Brass |
|  | VS | Stainless |
|  | BGP | Brushed Graphite |
|  | BN | Brushed Nickel |
|  | 2MB | Brushed Moderne Brass |
|  | BAF | Brushed French Gold |

KALLISTA

Foundations by KALLISTA
Traditional wall-mount kitchen pot filler
P31570-00

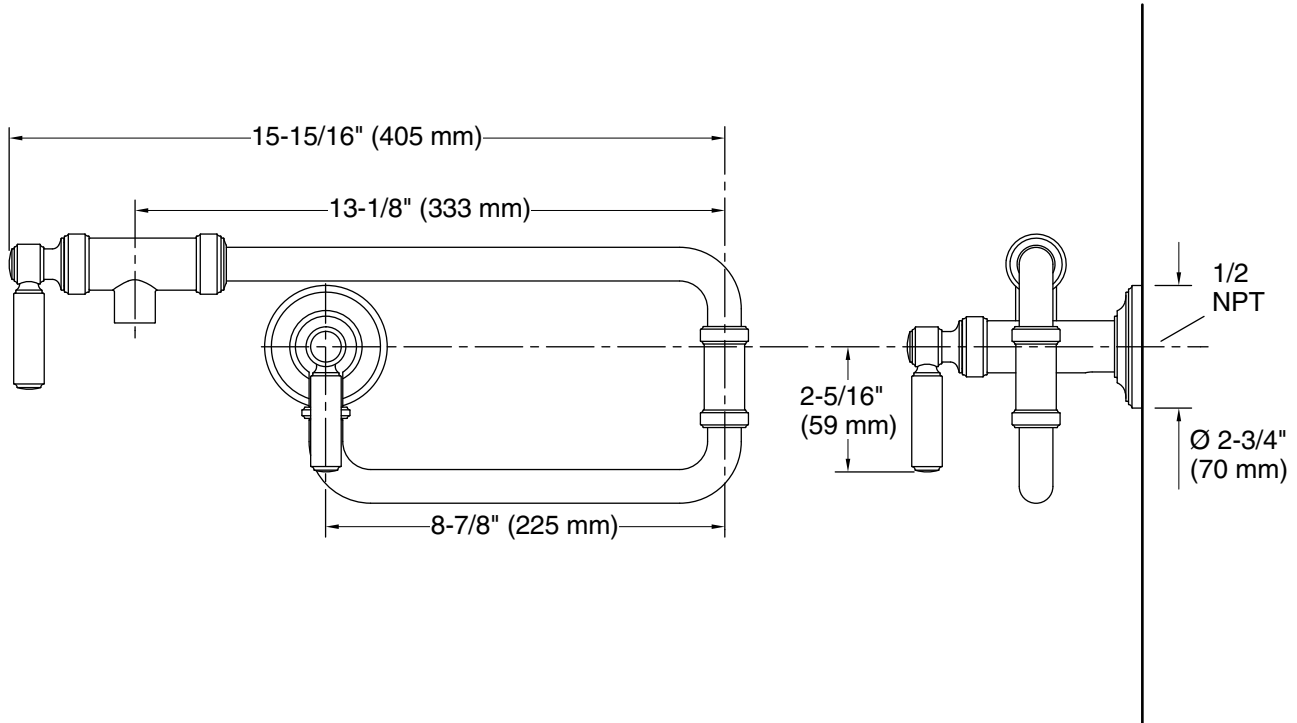

Technical Information

All product dimensions are nominal.

Faucet flow rate: 2.6 gal/min (9.8 l/min)

Drain included: No

Notes

Install this product according to the installation instructions.