

# KALLISTA®

## 002™ by KALLISTA Wall Mount Widespread Sink Faucet, White Carrara Cross Handles P32076-WC

### Features

- High-quality metal construction for durability and reliability
- Widespread sink faucet for 8" – 16" (203 – 406 mm) centers
- Spout reach is 7-3/16" (183 mm)
- 1.2 gpm (4.5 lpm) maximum flow rate
- Includes soft-touch drain
- Laminar flow

### Required Products/Accessories

For wall-mount installation  
P29304-00 Rough-In

### Recommended Products/Accessories

P34136-00 Towel Bar, 18"  
P34137-00 Towel Bar, 24"  
P34138-00 Towel Ring  
P34139-00 002™ Hook  
P34141-00 Toilet Paper Holder



**ADA** **CSA B651** **OBC**

### Codes/Standards







ASME A112.18.1/CSA B125.1  
NSF/ANSI/CAN 61  
NSF/ANSI/CAN 372  
DOE - Energy Policy Act 1992  
EPA WaterSense®  
California Energy Commission (CEC)  
ADA  
ICC/ANSI A117.1  
CSA B651  
OBC

### KALLISTA® Five-Year Limited Warranty

See website for detailed warranty  
information.

### Available Colors/Finishes

*Color tiles intended for reference only.*

| Color   | Code | Description           |
|---|------|-----------------------|
|  | CP   | Polished Chrome       |
|  | BL   | Matte Black           |
|  | SN   | Polished Nickel       |
|  | BAF  | Brushed French Gold   |
|  | BN   | Brushed Nickel        |
|  | 2MB  | Brushed Moderne Brass |

1-888-4-KALLISTA (1-888-452-5547)

Kallista reserves the right to make revisions without notice to product specifications.

For the most current Specification Sheet, go to [www.kallista.com](http://www.kallista.com).

2-16-2025 19:54 - US/CA

# KALLISTA

002™ by KALLISTA  
Wall Mount Widespread Sink Faucet, White  
Carrara Cross Handles  
P32076-WC

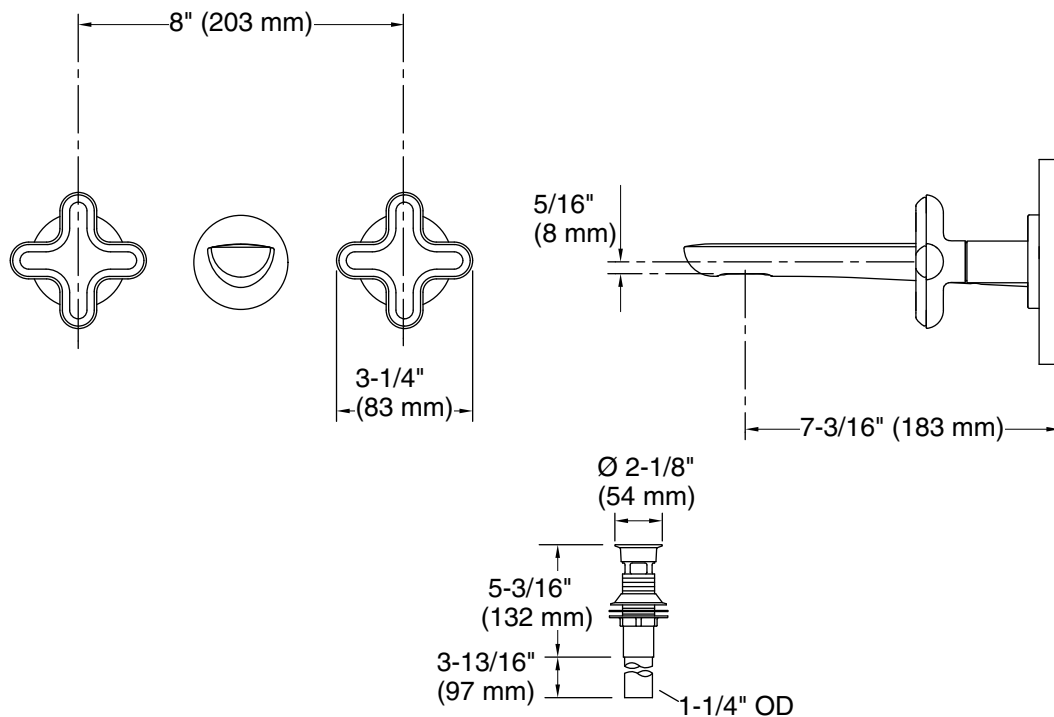

## Technical Information

All product dimensions are nominal.

Faucet flow rate: 1.2 gal/min (4.5 l/min)

Drain included: Yes

Drain with overflow: Yes

## Spout:

Spout reach: 7-3/16" (183 mm)

## Notes

Install this product according to the installation instructions.

ADA, OBC, CSA B651 compliant when installed to the specific requirements of these regulations.