

KALLISTA®

One™ by KALLISTA
Sink faucet, tall spout, FP5 decorative handles
P32413-LV

Features

- Solid metal construction for durability and reliability
- Widespread sink faucet for 8" – 16" (203 – 406 mm) centers
- Spout reach is 5-5/16" (135 mm)
- Laminar flow
- Includes soft-touch drain
- 1.2 gpm (4.5 lpm) maximum flow rate



ADA

CSA B651

OBC

Codes/Standards







ASME A112.18.1/CSA B125.1
NSF/ANSI/CAN 61
NSF/ANSI/CAN 372
DOE - Energy Policy Act 1992
EPA WaterSense®
California Energy Commission (CEC)
ADA
ICC/ANSI A117.1
CSA B651
OBC

KALLISTA® Five-Year Limited Warranty

See website for detailed warranty
information.

Available Colors/Finishes

Color tiles intended for reference only.

Color	Code	Description
	CP	Polished Chrome
	BL	Matte Black
	BAF	Brushed French Gold
	BN	Brushed Nickel
	SN	Polished Nickel
	2MB	Brushed Moderne Brass

1-888-4-KALLISTA (1-888-452-5547)

Kallista reserves the right to make revisions without notice to product specifications.

For the most current Specification Sheet, go to www.kallista.com.

2-15-2025 22:00 - US/CA

KALLISTA

One™ by KALLISTA
Sink faucet, tall spout, FP5 decorative handles
P32413-LV

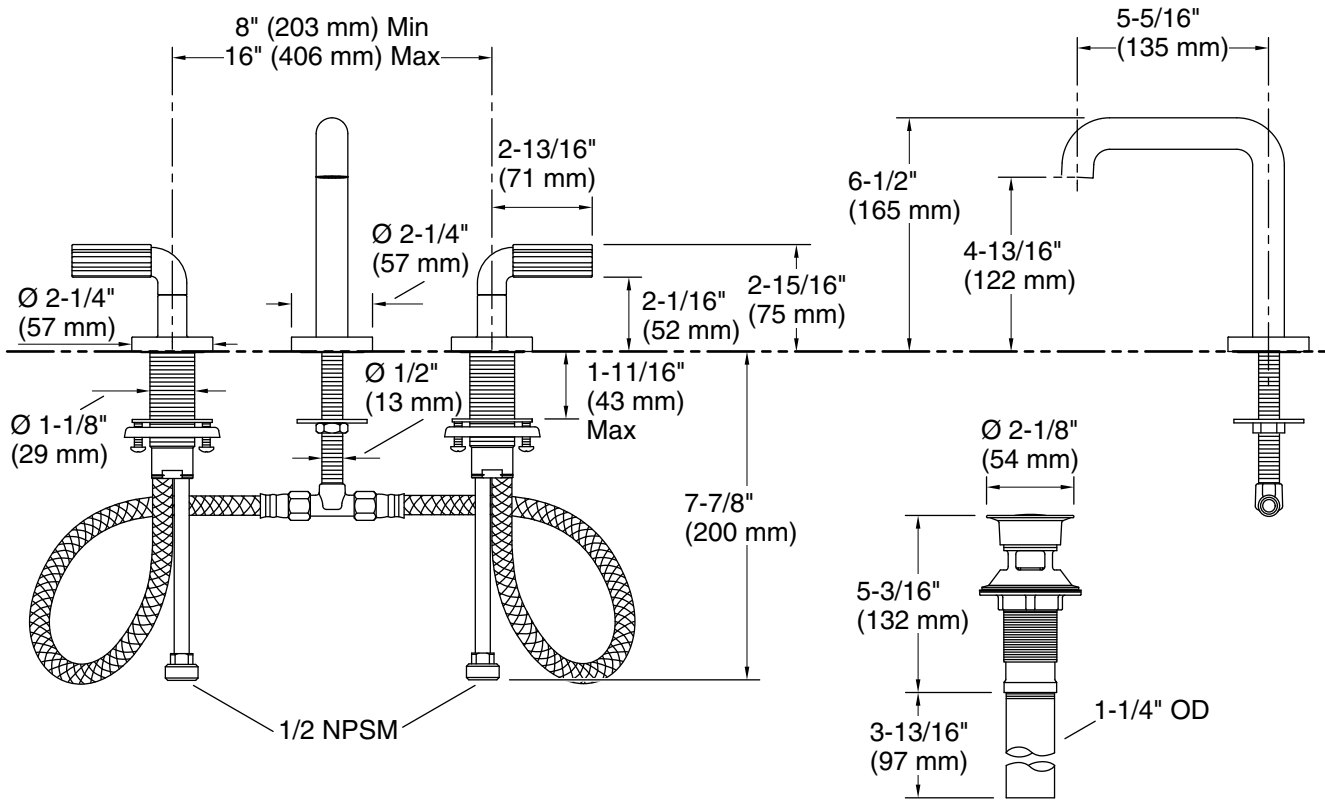

Technical Information

All product dimensions are nominal.

Faucet flow rate: 1.5 gal/min (5.7 l/min)

Drain included: Yes

Drain with overflow: Yes

Spout:

Spout reach: 5-5/16" (135 mm)

Notes

Install this product according to the installation instructions.

ADA, OBC, CSA B651 compliant when installed to the specific requirements of these regulations.

1-888-4-KALLISTA (1-888-452-5547)

Kallista reserves the right to make revisions without notice to product specifications.

For the most current Specification Sheet, go to www.kallista.com.

2-15-2025 22:00 - US/CA