

KALLISTA®

One™ by KALLISTA
Transfer trim, FP5 handle
P32415-LV

Features

- Solid metal construction for durability and reliability
- Allows for directed water flow
- Required rough-in sold separately

Optional Products/Accessories



ADA

CSA B651

OBC

Codes/Standards

ASME A112.18.1/CSA B125.1

ADA

ICC/ANSI A117.1

CSA B651







OBC

KALLISTA® Five-Year Limited Warranty

See website for detailed warranty
information.

Available Colors/Finishes

Color tiles intended for reference only.

Color	Code	Description
	CP	Polished Chrome
	BL	Matte Black
	BAF	Brushed French Gold
	BN	Brushed Nickel
	SN	Polished Nickel
	2MB	Brushed Moderne Brass

1-888-4-KALLISTA (1-888-452-5547)

Kallista reserves the right to make revisions without notice to product specifications.

For the most current Specification Sheet, go to www.kallista.com.

2-15-2025 22:00 - US/CA

KALLISTA

One™ by KALLISTA
Transfer trim, FP5 handle
P32415-LV

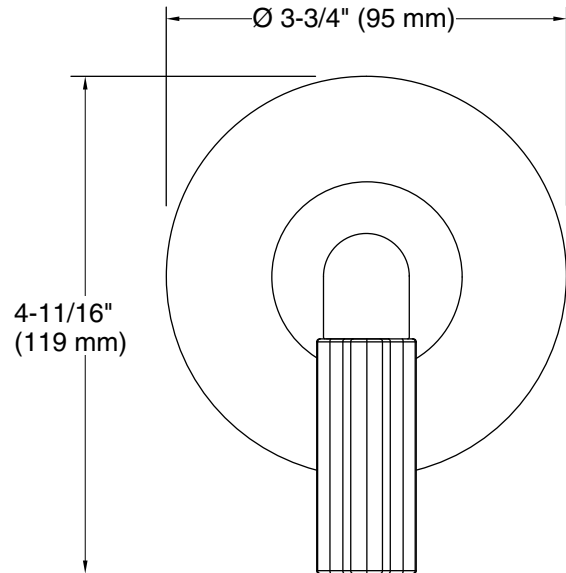
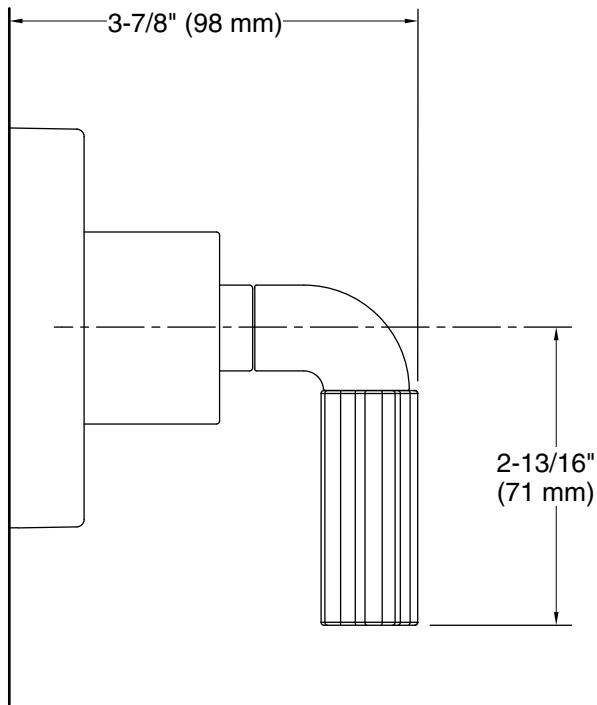

Technical Information

All product dimensions are nominal.

Drain included: No

Notes

Install this product according to the installation instructions.

ADA, OBC, CSA B651 compliant when installed to the specific requirements of these regulations.