

Features

- High-quality metal construction for durability and reliability
- Maintains water temperature within +/-3 degrees Fahrenheit
- Features a high-temperature-limit stop to help prevent scalding
- Required rough-in sold separately

Required Products/Accessories

P19310-00 Pressure Balance Rough-In

or

P19310-WS Pressure Balance Rough-In Valve With Stops

or

P29500-WS Thermostatic rough-in with volume control & stops

Recommended Products/Accessories

P32709-WC 002™ Transfer Trim, White Carrara

P34135-00 Round Contemporary Showerhead with Arm

P34137-00 Towel Bar, 24"

P24843-00 Wand Dual-Function Handshower with Hose

P21513-00 Air-Induction Large Contemporary Rain Showerhead



ADA **CSA B651** **OBC**

Codes/Standards

ASME A112.18.1/CSA B125.1

ADA

ICC/ANSI A117.1

CSA B651







OBC

KALLISTA® Five-Year Limited Warranty

See website for detailed warranty information.

Available Colors/Finishes

Color tiles intended for reference only.

Color	Code	Description
	CP	Polished Chrome
	BL	Matte Black
	BAF	Brushed French Gold
	BN	Brushed Nickel
	SN	Polished Nickel
	2MB	Brushed Moderne Brass

KALLISTA®

002™ by KALLISTA
Single Control Trim, White Carrara Cross Handle
P32707-WC

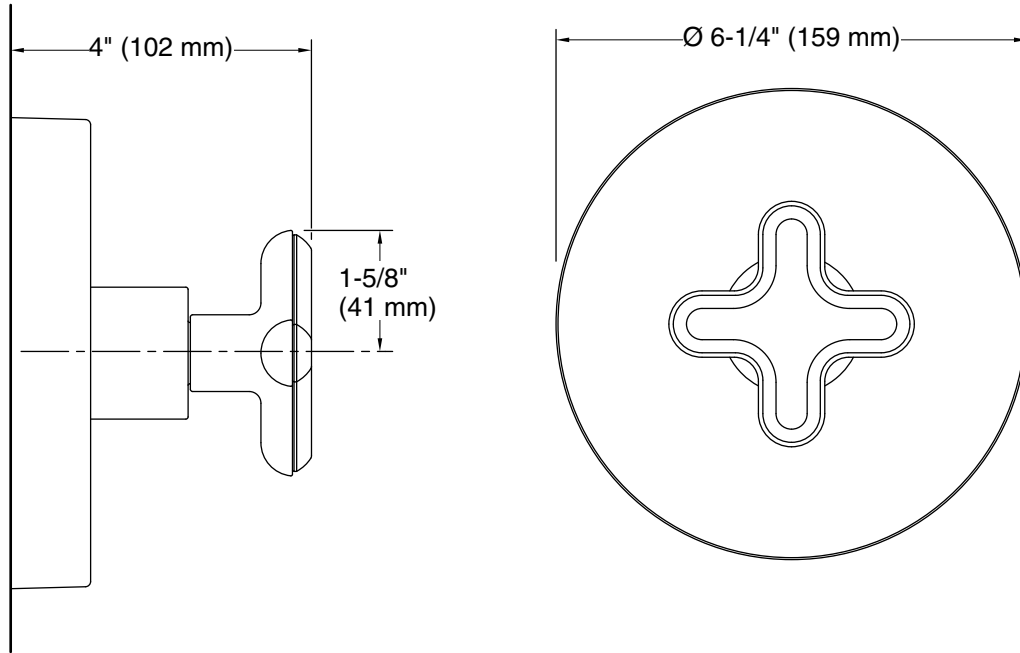

Technical Information

All product dimensions are nominal.

Drain included: No

Notes

Install this product according to the installation instructions.

ADA, OBC, CSA B651 compliant when installed to the specific requirements of these regulations.