

Features

- High-quality metal construction for durability and reliability
- Precise temperature setting capability
- Patented K-joint installation ensures consistent trim appearance
- Required rough-in sold separately

Required Products/Accessories

P29512-WS 3/4" Thermostatic Mixing Valve

or

P29511-WS 1/2" Thermostatic Mixing Valve

Recommended Products/Accessories

P32710-WC 002™ Volume Control Trim, White Carrara

P32709-WC 002™ Transfer Trim, White Carrara

P34135-00 Round Contemporary Showerhead with Arm

P21513-00 Air-Induction Large Contemporary Rain Showerhead

P34137-00 Towel Bar, 24"



ADA

CSA B651

OBC

Codes/Standards

ASME A112.18.1/CSA B125.1

ADA

ICC/ANSI A117.1

CSA B651

OBC

NOM Standards







NOM 012-CONAGUA

KALLISTA® Five-Year Limited Warranty

See website for detailed warranty information.

Available Colors/Finishes

Color tiles intended for reference only.

Color	Code	Description
	CP	Polished Chrome
	BL	Matte Black
	SN	Polished Nickel
	BAF	Brushed French Gold
	BN	Brushed Nickel
	2MB	Brushed Moderne Brass

KALLISTA®

002® by KALLISTA
Thermostatic Trim, White Carrara Cross Handle
P32708-WC

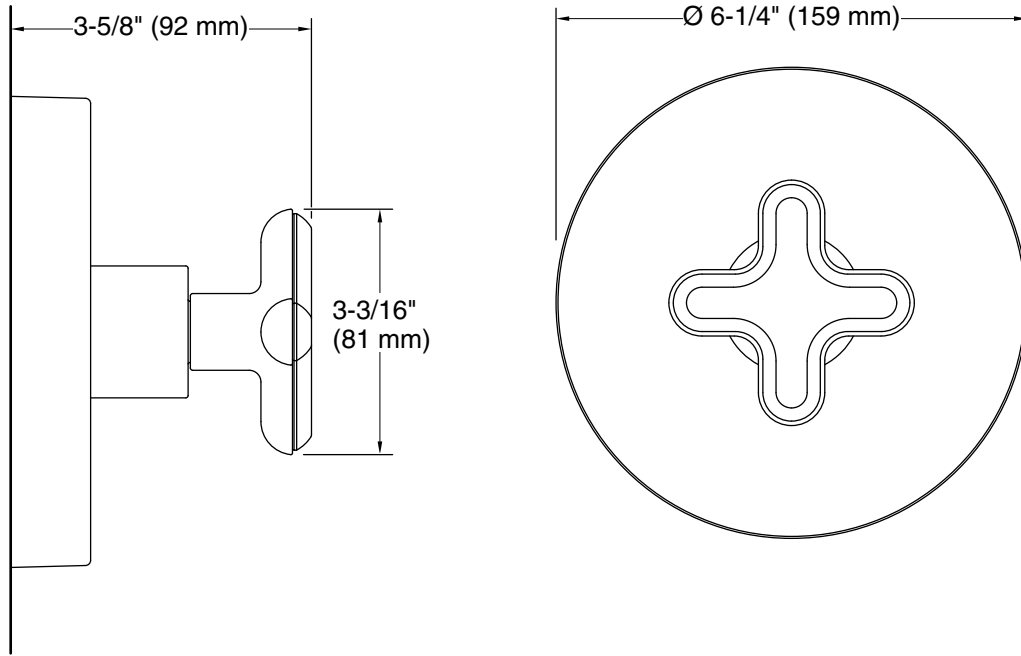

Technical Information

All product dimensions are nominal.

Notes

Install this product according to the installation instructions.

ADA, OBC, CSA B651 compliant when installed to the specific requirements of these regulations.