

KALLISTA®

002™ by KALLISTA 002™ Deck-Mount Bath Faucet, Rose Quartz P32711-RST

Features

- High-quality metal construction for durability and reliability
- Spout reach is 7-5/16" (186 mm)
- Required rough-in sold separately
- Widespread bath faucet for 8" – 16" (203 – 406 mm) centers

Required Products/Accessories

For deck-mount installation

P19303-00 3/4" Ceramic High-Flow Valve System

Adapters, Rough-in and Extension Kits

P19303-00 Range: 1/2" (13 mm) - 2" (51 mm)

Recommended Products/Accessories

P50045-00 Large Rectangular Bathtub
P21930-00 Contemporary Drain Trim Kit
P34137-00 Towel Bar, 24"



ADA

CSA B651

OBC

Codes/Standards

ASME A112.18.1/CSA B125.1

ADA

ICC/ANSI A117.1

CSA B651







OBC

KALLISTA® Five-Year Limited Warranty

See website for detailed warranty information.

Available Colors/Finishes

Color tiles intended for reference only.

Color	Code	Description
	CP	Polished Chrome
	BL	Matte Black
	BAF	Brushed French Gold
	BN	Brushed Nickel
	SN	Polished Nickel
	2MB	Brushed Moderne Brass

1-888-4-KALLISTA (1-888-452-5547)

Kallista reserves the right to make revisions without notice to product specifications.

For the most current Specification Sheet, go to www.kallista.com.

2-16-2025 19:53 - US/CA

KALLISTA

002™ by KALLISTA
002™ Deck-Mount Bath Faucet, Rose Quartz
P32711-RST

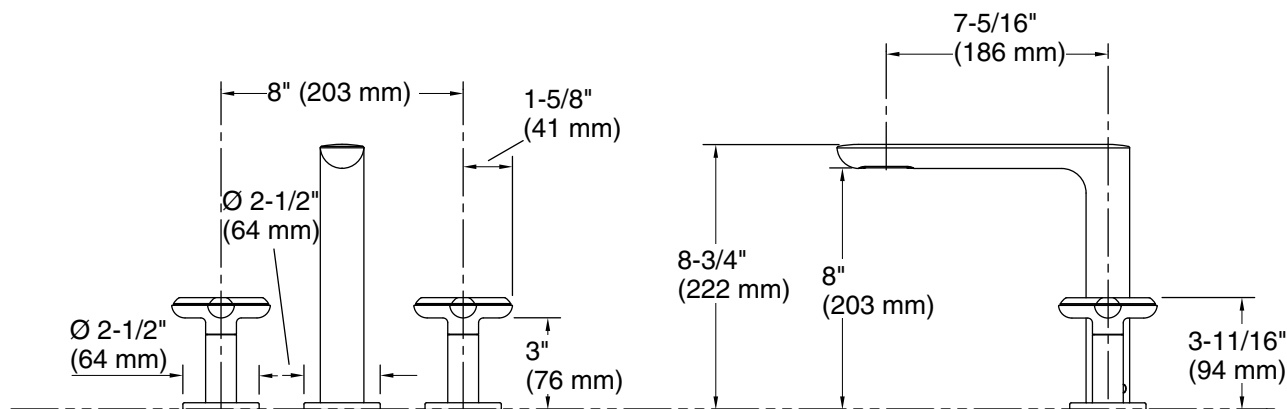

Technical Information

All product dimensions are nominal.

Faucet flow rate: 7 gal/min (26.5 l/min)

Drain included: No

Spout:

Spout reach: $7\text{-}5/16\text{'}$ (186 mm)

Notes

Install this product according to the installation instructions.

ADA, OBC, CSA B651 compliant when installed to the specific requirements of these regulations.