

# KALLISTA®

## Bezel™ by CRISTINA Rubinetterie Bezel™ Freestanding Bath Faucet with Handshower, White Carrara Handle P32713-WC

### Features

- High-quality solid-brass construction for durability and reliability
- Italian natural stone handle
- Faceted knob handle design with precision alignment
- Dual valve platform allows for simultaneous actuation of spout and handshower as desired
- Floor-mount, single hole installation
- 36-11/16" (932 mm) total height
- 32-1/2" (826 mm) spout height
- 9-1/16" (230 mm) spout reach
- Includes handshower
- Required rough-in sold separately
- 1.75 gpm (6.6 lpm) handshower flow rate

### Required Products/Accessories

For freestanding installation

P32715-00 Floormount Rough In

### Recommended Products/Accessories

P32742-00 Bezel™ 18" Towel Bar

P32743-00 Bezel™ 24" Towel Bar

P32745-00 Bezel™ Robe Hook

P50206-00 Freestanding Bathtub

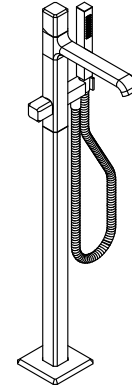

### Codes/Standards

ASME A112.18.1/CSA B125.1

DOE - Energy Policy Act 1992







California Energy Commission (CEC)

### KALLISTA® Five-Year Limited Warranty

See website for detailed warranty information.

### Available Colors/Finishes

*Color tiles intended for reference only.*

Color	Code	Description
	CP	Polished Chrome
	BLH	Blush Brass
	BN	Brushed Nickel
	BGP	Brushed Graphite
	2MB	Brushed Moderne Brass
	PGP	Polished Graphite

1-888-4-KALLISTA (1-888-452-5547)

Kallista reserves the right to make revisions without notice to product specifications.

For the most current Specification Sheet, go to [www.kallista.com](http://www.kallista.com).

2-20-2025 15:00 - US/CA

# KALLISTA®

## Bezel™ by CRISTINA Rubinetterie Bezel™ Freestanding Bath Faucet with Handshower, White Carrara Handle P32713-WC

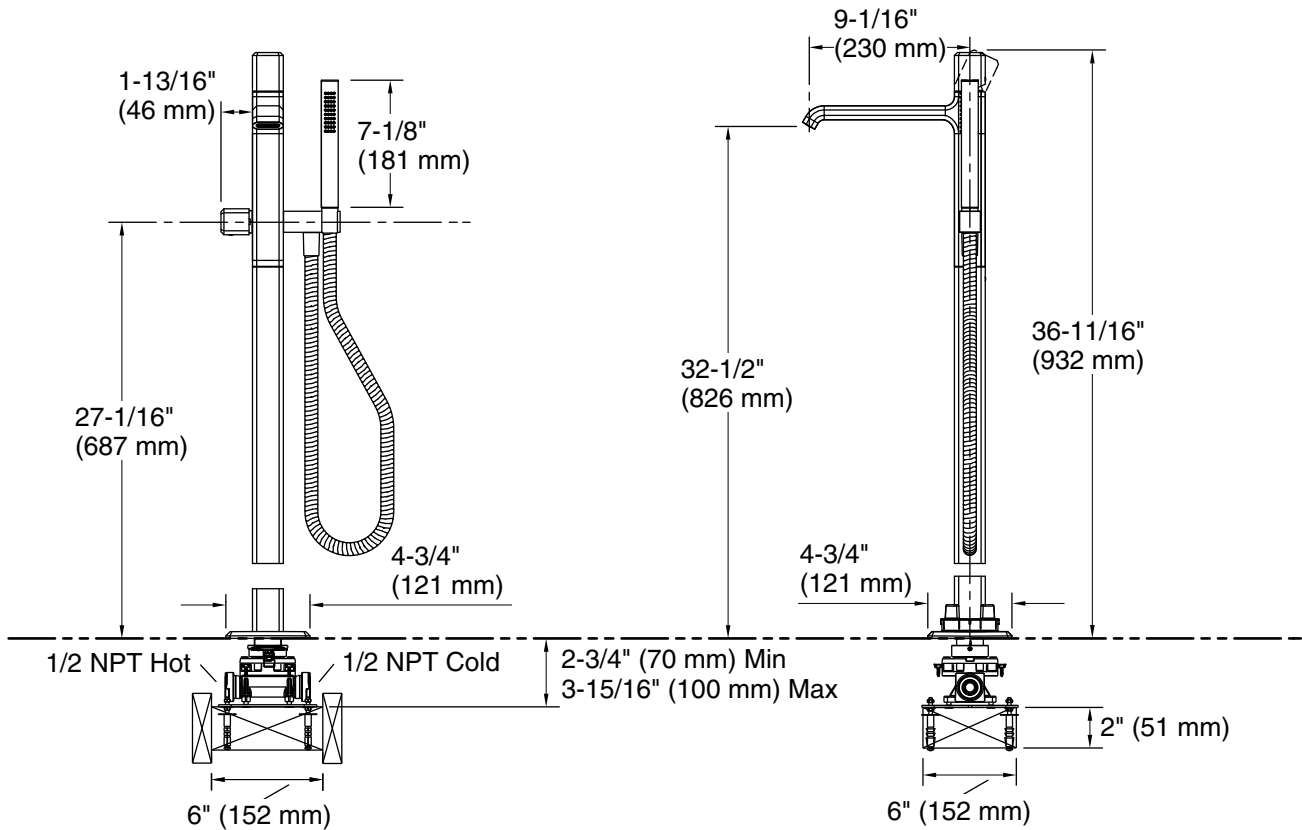

### Technical Information

All product dimensions are nominal.

Faucet flow rate: 5 gal/min (18.9 l/min)

Drain included: No

Spout:

Spout reach: 9-1/16" (230 mm)

Handshower rated max flow: 1.75 gal/min (6.6 l/min)

### Notes

Install this product according to the installation instructions.