

# KALLISTA®

## Foundations by KALLISTA Modern Round Showerhead with Arm P32939-00

### Features

- High-quality solid-brass construction for durability and reliability
- Wall-mount installation
- Adjustable pivoting sprayface
- Easy-to-clean sprayface resists mineral buildup
- Single-function spray
- 1.75 gpm (6.6 lpm) maximum flow rate

### Recommended Products/Accessories

- P33491-LV Aileron™ Thermostatic Trim
- P33489-LV Aileron™ Volume Control Trim
- P33490-LV Aileron™ Eco Transfer Trim
- P32937-00 Modern Round 11" Raindome
- P32964-00 Modern Round Handshower with Hose

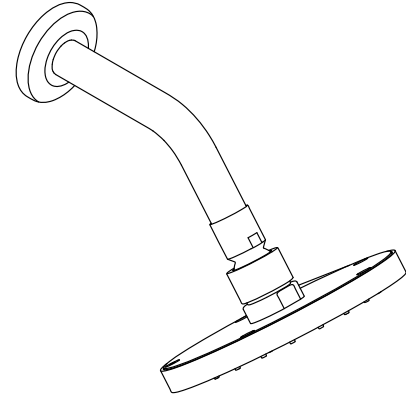

### Codes/Standards







- ASME A112.18.1/CSA B125.1
- DOE - Energy Policy Act 1992
- EPA WaterSense®
- California Energy Commission (CEC)

### KALLISTA® Five-Year Limited Warranty

See website for detailed warranty information.

### Available Colors/Finishes

*Color tiles intended for reference only.*

Color	Code	Description
	CP	Polished Chrome
	BL	Matte Black
	BLH	Blush Brass
	2MB	Brushed Moderne Brass
	BGP	Brushed Graphite
	BN	Brushed Nickel
	PGP	Polished Graphite

1-888-4-KALLISTA (1-888-452-5547)

Kallista reserves the right to make revisions without notice to product specifications.

For the most current Specification Sheet, go to [www.kallista.com](http://www.kallista.com).

1-30-2025 12:19 - US/CA

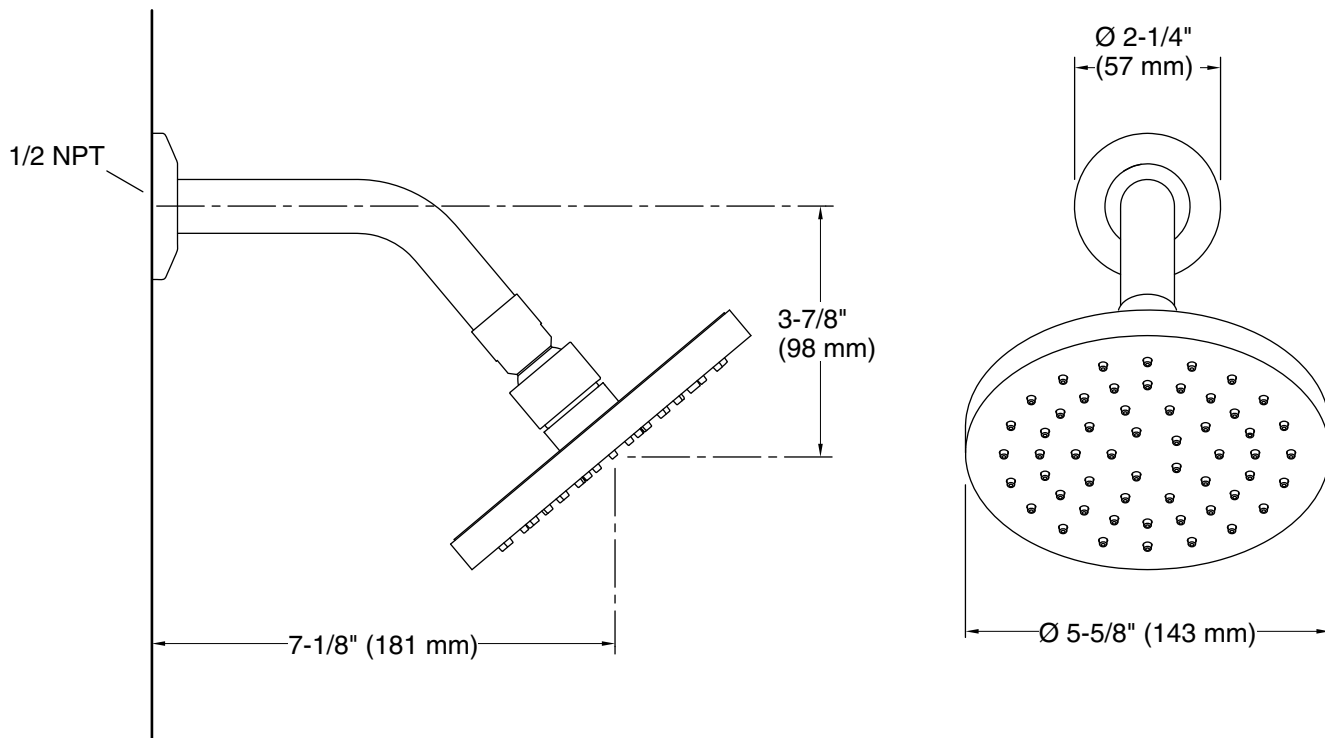

### Technical Information

All product dimensions are nominal.

Drain included: No

Shower/Rainhead rated max flow: 1.75 gal/min (6.6 l/min)

### Notes

Install this product according to the installation instructions.