

# KALLISTA®

## Aileron™ by CRISTINA Rubinetteria Aileron™ Single Control Sink Faucet, Low Spout P33351-LV

### Features

- High-quality solid-brass construction for durability and reliability
- Intricate knurling detail
- Lever handle
- Single-hole installation
- 6-15/16" (176 mm) total height
- 3-3/8" (86 mm) spout height
- 4-15/16" (125 mm) spout reach
- 1.2 gpm (4.5 lpm) maximum flow rate
- Includes quiet clicker drain

### Recommended Products/Accessories

- P33004-00 Aileron™ 24" Towel Bar
- P33003-00 Aileron™ 18" Towel Bar
- P33002-00 Aileron™ 12" Towel Bar
- P33005-00 Aileron™ Robe Hook
- P33006-00 Aileron™ Toilet Paper Holder

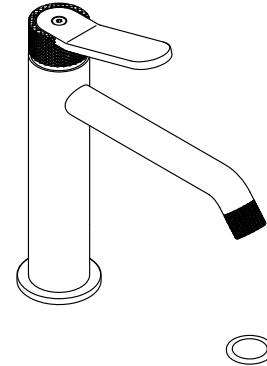

**ADA** **CSA B651** **OBC**

### Codes/Standards







ASME A112.18.1/CSA B125.1  
NSF/ANSI/CAN 61  
NSF/ANSI/CAN 372  
DOE - Energy Policy Act 1992  
EPA WaterSense®  
California Energy Commission (CEC)  
ADA  
ICC/ANSI A117.1  
CSA B651  
OBC

### KALLISTA® Five-Year Limited Warranty

See website for detailed warranty  
information.

### Available Colors/Finishes

*Color tiles intended for reference only.*

Color	Code	Description
	CP	Polished Chrome
	BL	Matte Black
	BLH	Blush Brass
	BN	Brushed Nickel
	BGP	Brushed Graphite
	2MB	Brushed Moderne Brass

1-888-4-KALLISTA (1-888-452-5547)

Kallista reserves the right to make revisions without notice to product specifications.

For the most current Specification Sheet, go to [www.kallista.com](http://www.kallista.com).

1-30-2025 00:12 - US/CA

# KALLISTA®

## Aileron™ by CRISTINA Rubinetterie Aileron™ Single Control Sink Faucet, Low Spout P33351-LV

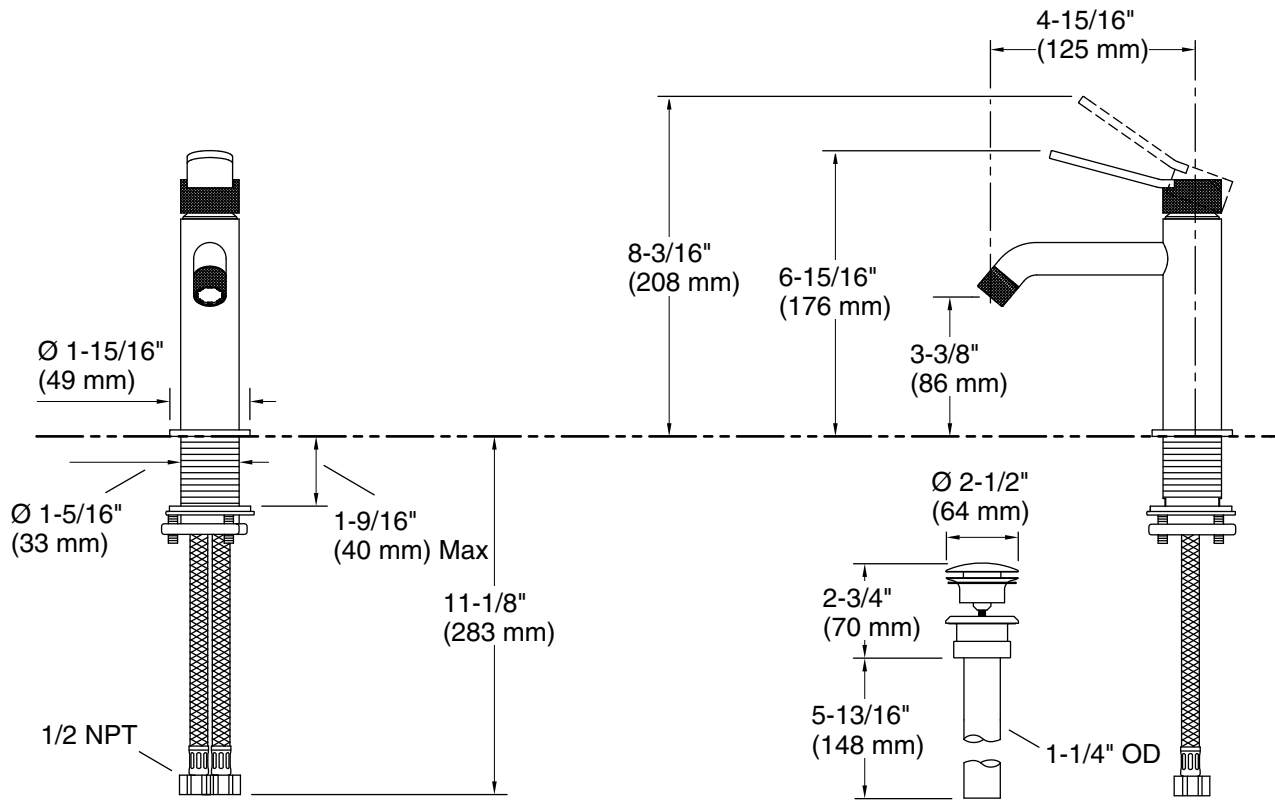

### Technical Information

All product dimensions are nominal.

Faucet flow rate: 1.2 gal/min (4.5 l/min)

Drain included: Yes

Drain with overflow: Yes

Spout:

Spout reach: 4-15/16" (125 mm)

### Notes

Install this product according to the installation instructions.

ADA, OBC, CSA B651 compliant when installed to the specific requirements of these regulations.