

KALLISTA®

Aileron™ by CRISTINA Rubinetterie Aileron™ Single Control Sink Faucet P33352-LV

Features

- High-quality solid-brass construction for durability and reliability
- Intricate knurling detail
- Lever handle
- Single-hole installation
- 9-11/16" (246 mm) total height
- 6-1/8" (156 mm) spout height
- Spout reach is 6-3/8" (162 mm)
- 1.2 gpm (4.5 lpm) maximum flow rate
- Includes quiet clicker drain

Recommended Products/Accessories

- P33004-00 Aileron™ 24" Towel Bar
- P33003-00 Aileron™ 18" Towel Bar
- P33002-00 Aileron™ 12" Towel Bar
- P33005-00 Aileron™ Robe Hook
- P33006-00 Aileron™ Toilet Paper Holder

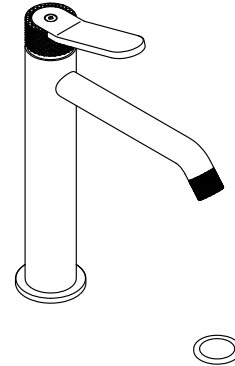

Codes/Standards







ASME A112.18.1/CSA B125.1
NSF/ANSI/CAN 61
NSF/ANSI/CAN 372
DOE - Energy Policy Act 1992
EPA WaterSense®
California Energy Commission (CEC)

KALLISTA® Five-Year Limited Warranty

See website for detailed warranty information.

Available Colors/Finishes

Color tiles intended for reference only.

Color	Code	Description
	CP	Polished Chrome
	BL	Matte Black
	BLH	Blush Brass
	BGP	Brushed Graphite
	2MB	Brushed Moderne Brass
	BN	Brushed Nickel

1-888-4-KALLISTA (1-888-452-5547)

Kallista reserves the right to make revisions without notice to product specifications.

For the most current Specification Sheet, go to www.kallista.com.

1-30-2025 00:12 - US/CA

KALLISTA®

Aileron™ by CRISTINA Rubinetterie Aileron™ Single Control Sink Faucet P33352-LV

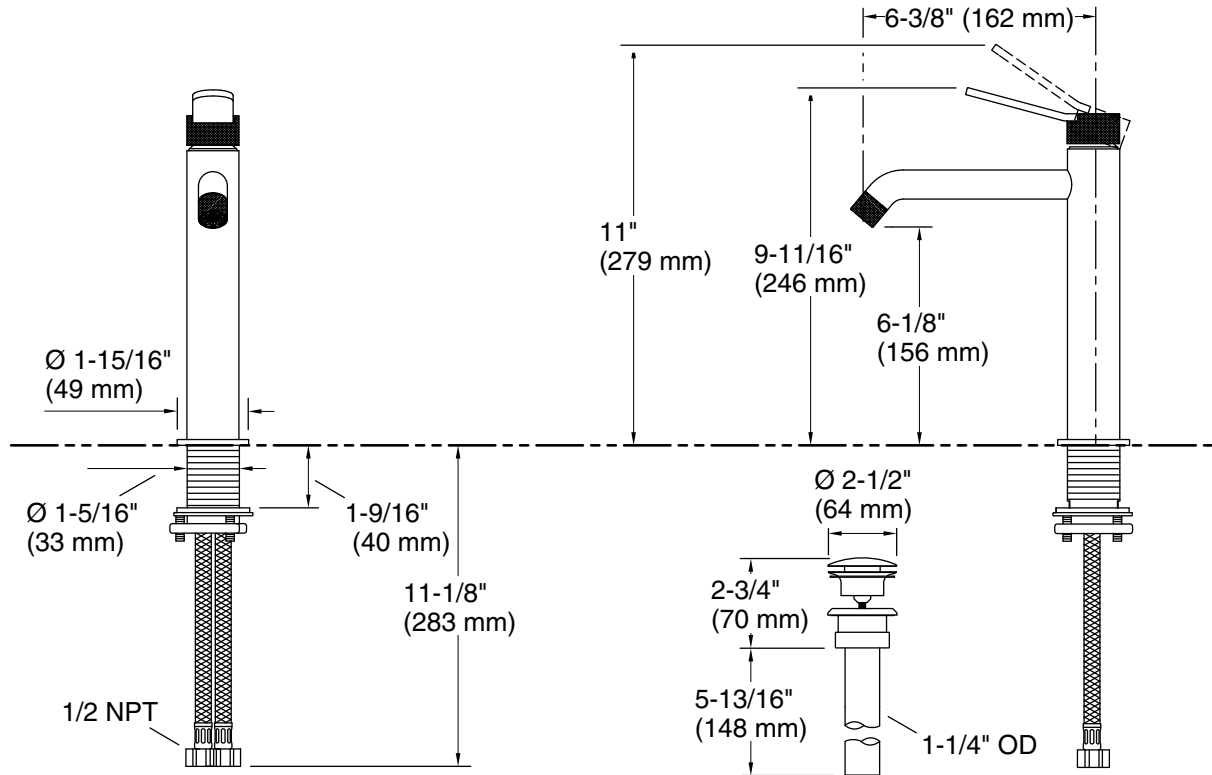

Technical Information

All product dimensions are nominal.

Faucet flow rate: 1.2 gal/min (4.5 l/min)

Drain included: Yes

Drain with
overflow: Yes

Spout:

Spout reach: $6\text{-}3/8\text{''}$ (162 mm)

Notes

Install this product according to the installation instructions.