

KALLISTA®

KALLISTA Sink strainer P34000-00

Features

- A selection of products within this collection is in stock and ready to ship. Please visit kallista.com/resources#ReadyToShip for the complete list of Ready-to-Ship products and finishes
- High-quality solid-brass construction for durability and reliability
- Includes tailpiece
- Removable basket strainer with open/close stopper
- Extra-durable finish complements high-traffic environments

Recommended Products/Accessories

P25200-00 Pull-Down Kitchen Faucet
P25015-00 Soap/Lotion Dispenser
P23174-2MB Semi-Professional Faucet
P30801-00 4" cabinet pull



Codes/Standards







ASME A112.18.2/CSA B125.2

KALLISTA® Five-Year Limited Warranty

See website for detailed warranty information.

Available Colors/Finishes

Color tiles intended for reference only.

Color	Code	Description
	CP	Polished Chrome
	AG	Brushed Nickel
	BL	Matte Black
	BGP	Brushed Graphite
	PB	Polished Brass
	PGP	Polished Graphite
	SN	Polished Nickel
	VS	Stainless
	2MB	Brushed Moderne Brass
	BV	Brushed Bronze
	BAF	Brushed French Gold

1-888-4-KALLISTA (1-888-452-5547)

Kallista reserves the right to make revisions without notice to product specifications.

For the most current Specification Sheet, go to www.kallista.com.

3-1-2026 21:30 - US/CA

KALLISTA

KALLISTA
Sink strainer
P34000-00

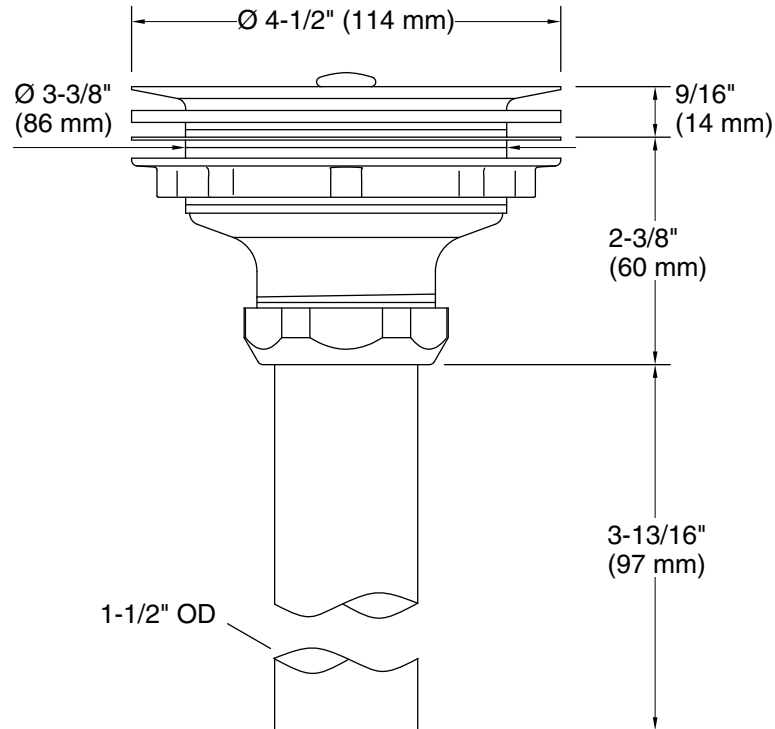

Technical Information

All product dimensions are nominal.

Material: Brass, Zinc, Stainless Steel

1-888-4-KALLISTA (1-888-452-5547)

Kallista reserves the right to make revisions without notice to product specifications.

For the most current Specification Sheet, go to www.kallista.com.

3-1-2026 21:30 - US/CA