

KALLISTA®

002™ by KALLISTA Widespread Sink Faucet, Low Spout, Lever Handles P34119-LV

Features

- High-quality solid metal construction for durability and reliability
- Widespread sink faucet for 8" – 16" (203 – 406 mm) centers
- 3-7/8" (98 mm) spout height
- Spout reach is 5-5/16" (135 mm)
- 1.2 gpm (4.5 lpm) maximum flow rate
- Includes drain and lift rod
- Laminar flow

Recommended Products/Accessories

- P74234-WO Under-mount Sink, Soft Rectangle with Overflow, Glazed
- P34136-00 Towel Bar, 18"
- P34137-00 Towel Bar, 24"
- P34138-00 Towel Ring
- P34139-00 002™ Hook
- P34141-00 Toilet Paper Holder



ADA **CSA B651** **OBC**

Codes/Standards







ASME A112.18.1/CSA B125.1
NSF/ANSI/CAN 61
NSF/ANSI/CAN 372
DOE - Energy Policy Act 1992
EPA WaterSense®
California Energy Commission (CEC)
ADA
ICC/ANSI A117.1
CSA B651
OBC

KALLISTA® Five-Year Limited Warranty

See website for detailed warranty information.

Available Colors/Finishes

Color tiles intended for reference only.

Color	Code	Description
	CP	Polished Chrome
	BL	Matte Black
	SN	Polished Nickel
	BAF	Brushed French Gold
	BN	Brushed Nickel
	2MB	Brushed Moderne Brass

1-888-4-KALLISTA (1-888-452-5547)

Kallista reserves the right to make revisions without notice to product specifications.

For the most current Specification Sheet, go to www.kallista.com.

2-16-2025 19:55 - US/CA

KALLISTA

002™ by KALLISTA
 Widespread Sink Faucet, Low Spout, Lever
 Handles
 P34119-LV

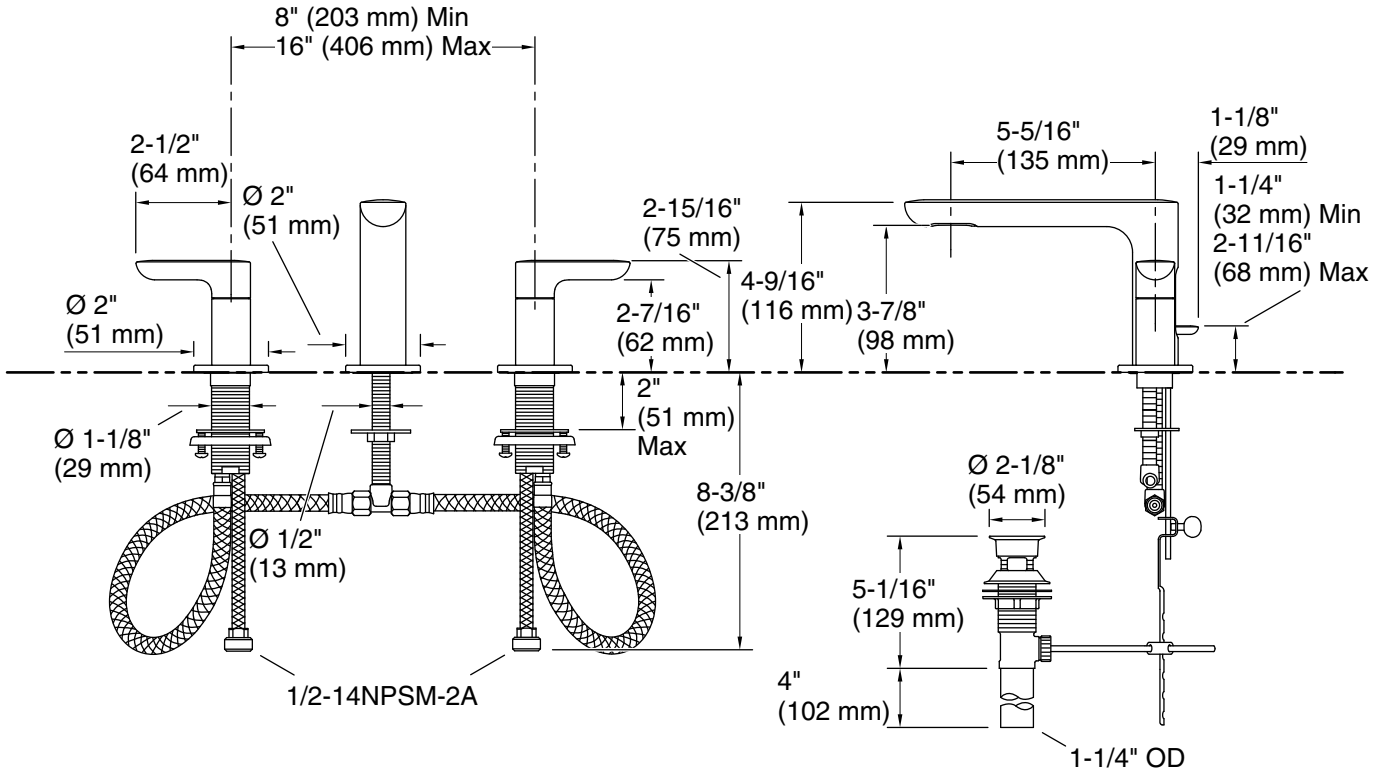

Technical Information

All product dimensions are nominal.

Faucet flow rate: 1.2 gal/min (4.5 l/min)

Drain included: Yes

Drain with overflow: Yes

Spout:

Spout reach: 2-3/8" (136 mm)

Notes

Install this product according to the installation instructions.

ADA, OBC, CSA B651 compliant when installed to the specific requirements of these regulations.