

# KALLISTA®

002™ by KALLISTA  
Wall Mount Single Control Sink Faucet, Lever  
Handle  
P34124-00

## Features

- Single-handle control
- High-quality metal construction for durability and reliability
- Spout reach is 7-3/16" (183 mm)
- Includes soft-touch drain
- 1.2 gpm (4.5 lpm) maximum flow rate

## Required Products/Accessories

For wall-mount installation

P41299-00 Ceramic valve for wall-mount single-control sink faucet

## Recommended Products/Accessories

P34136-00 Towel Bar, 18"

P34137-00 Towel Bar, 24"

P34138-00 Towel Ring

P34139-00 002™ Hook

P34141-00 Toilet Paper Holder



**ADA** **CSA B651** **OBC**

## Codes/Standards

ASME A112.18.1/CSA B125.1

NSF/ANSI/CAN 61

NSF/ANSI/CAN 372

DOE - Energy Policy Act 1992

EPA WaterSense®

California Energy Commission (CEC)

ADA

ICC/ANSI A117.1

CSA B651







OBC

## KALLISTA® Five-Year Limited Warranty

See website for detailed warranty information.

## Available Colors/Finishes

*Color tiles intended for reference only.*

Color	Code	Description
	CP	Polished Chrome
	BL	Matte Black
	BAF	Brushed French Gold
	BN	Brushed Nickel
	SN	Polished Nickel
	2MB	Brushed Moderne Brass

1-888-4-KALLISTA (1-888-452-5547)

Kallista reserves the right to make revisions without notice to product specifications.

For the most current Specification Sheet, go to [www.kallista.com](http://www.kallista.com).

2-16-2025 19:53 - US/CA

# KALLISTA

002™ by KALLISTA  
Wall Mount Single Control Sink Faucet, Lever  
Handle  
P34124-00

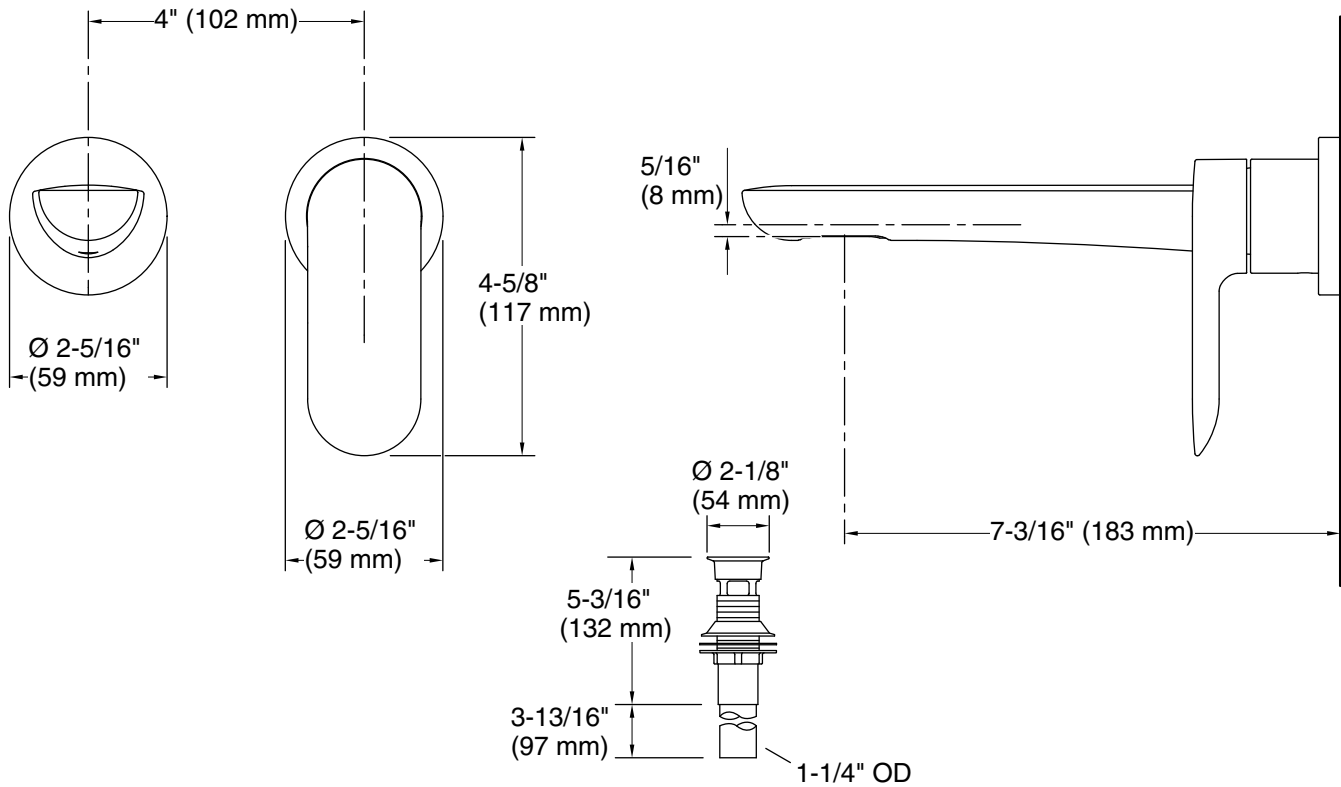

## Technical Information

All product dimensions are nominal.

Faucet flow rate: 1.2 gal/min (4.5 l/min)

Drain included: Yes

Drain with overflow: Yes

## Spout:

Spout reach:  $7\text{-}3/16\text{'}$  (183 mm)

## Notes

Install this product according to the installation instructions.

ADA, OBC, CSA B651 compliant when installed to the specific requirements of these regulations.