

# KALLISTA®

002™ by KALLISTA  
Single Control trim, lever handle  
P34130-LV

## Features

- High-quality metal construction for durability and reliability
- Maintains water temperature within +/-3 degrees Fahrenheit
- Features a high-temperature-limit stop to help prevent scalding
- Required rough-in sold separately

## Required Products/Accessories

P29500-WS Thermostatic rough-in with volume control & stops

or

P19310-00 Pressure Balance Rough-In

or

P19310-WS Pressure Balance Rough-In Valve With Stops

## Recommended Products/Accessories

P34135-00 Round Contemporary Showerhead with Arm

P34137-00 Towel Bar, 24"

P24843-00 Wand Dual-Function Handshower with Hose

P21513-00 Air-Induction Large Contemporary Rain Showerhead



ADA

CSA B651

OBC

## Codes/Standards

ASME A112.18.1/CSA B125.1

ADA

ICC/ANSI A117.1

CSA B651







OBC

## KALLISTA® Five-Year Limited Warranty

See website for detailed warranty information.

## Available Colors/Finishes

*Color tiles intended for reference only.*

Color	Code	Description
	CP	Polished Chrome
	BL	Matte Black
	BAF	Brushed French Gold
	BN	Brushed Nickel
	SN	Polished Nickel
	2MB	Brushed Moderne Brass

1-888-4-KALLISTA (1-888-452-5547)

Kallista reserves the right to make revisions without notice to product specifications.

For the most current Specification Sheet, go to [www.kallista.com](http://www.kallista.com).

2-16-2025 19:50 - US/CA

# KALLISTA®

002™ by KALLISTA  
Single Control trim, lever handle  
P34130-LV

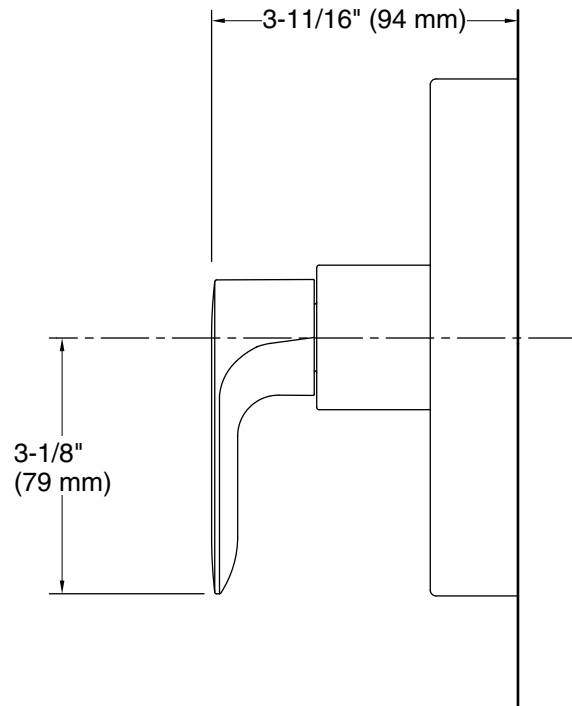
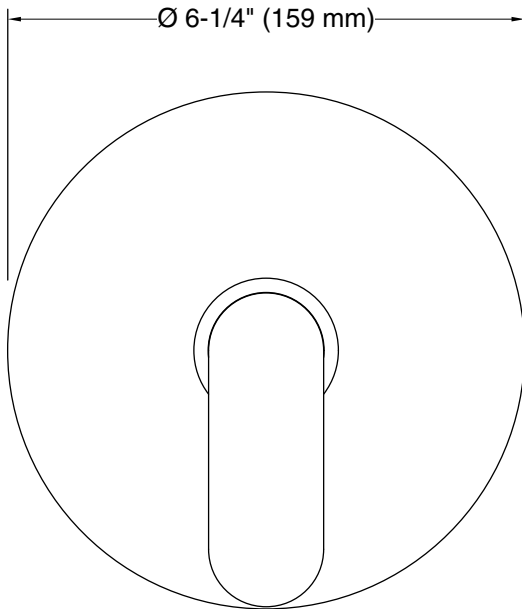

## Technical Information

All product dimensions are nominal.

Drain included: No

## Notes

Install this product according to the installation instructions.

ADA, OBC, CSA B651 compliant when installed to the specific requirements of these regulations.