

Features

- High-quality metal construction for durability and reliability
- Maintains water temperature within +/-3 degrees Fahrenheit
- Features a high-temperature-limit stop to help prevent scalding
- Required rough-in sold separately

Required Products/Accessories

P29305-00 Pressure Balance Rough-In Assembly with Diverter

or

P29305-WS Pressure Balance Rough-In Assembly with Stops and Diverter

Recommended Products/Accessories

- P34135-00 Round Contemporary Showerhead with Arm
- P34134-LV Volume Control Trim, Lever Handle
- P34129-00 Wall-Mount Bath Spout
- P24843-00 Wand Dual-Function Handshower with Hose



ADA **CSA B651** **OBC**

Codes/Standards







ASME A112.18.1/CSA B125.1
 ADA
 ICC/ANSI A117.1
 CSA B651
 OBC

KALLISTA® Five-Year Limited Warranty

See website for detailed warranty information.

Available Colors/Finishes

Color tiles intended for reference only.

Color	Code	Description
	CP	Polished Chrome
	BL	Matte Black
	BN	Brushed Nickel
	BAF	Brushed French Gold
	SN	Polished Nickel
	2MB	Brushed Moderne Brass

KALLISTA®

002® by KALLISTA
Single Control trim with diverter, lever handle
P34131-LV

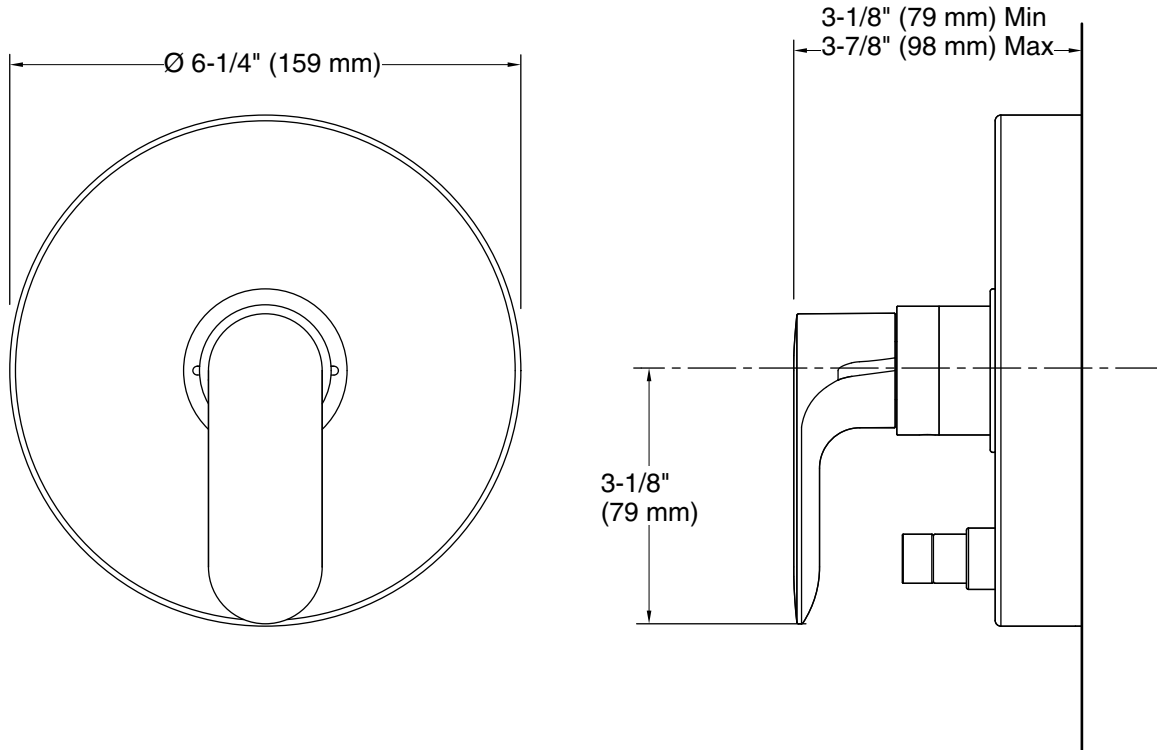

Technical Information

All product dimensions are nominal.

Notes

Install this product according to the installation instructions.

ADA, OBC, CSA B651 compliant when installed to the specific requirements of these regulations.