

## Features

- High-quality solid metal construction for durability and reliability
- Offers a customizable shower experience
- Patented K-joint installation ensures consistent trim appearance
- Required rough-in sold separately

## Required Products/Accessories

- P29527-00 1/2" Volume Control Rough-In Assembly  
 or  
 P29528-00 3/4" Volume Control Rough-In Assembly

## Recommended Products/Accessories

- P34132-LV Thermostatic trim, lever handle  
 P34133-LV Transfer Trim, Lever Handle  
 P21513-00 Air-Induction Large Contemporary Rain Showerhead  
 P34135-00 Round Contemporary Showerhead with Arm



## Codes/Standards







- ASME A112.18.1/CSA B125.1  
 ADA  
 ICC/ANSI A117.1  
 CSA B651  
 OBC  
 NOM Standards  
 NOM 012-CONAGUA

## KALLISTA® Five-Year Limited Warranty

See website for detailed warranty information.

## Available Colors/Finishes

*Color tiles intended for reference only.*

Color	Code	Description
	CP	Polished Chrome
	BL	Matte Black
	BAF	Brushed French Gold
	BN	Brushed Nickel
	SN	Polished Nickel
	2MB	Brushed Moderne Brass

# KALLISTA®

002® by KALLISTA  
Volume Control Trim, Lever Handle  
P34134-LV

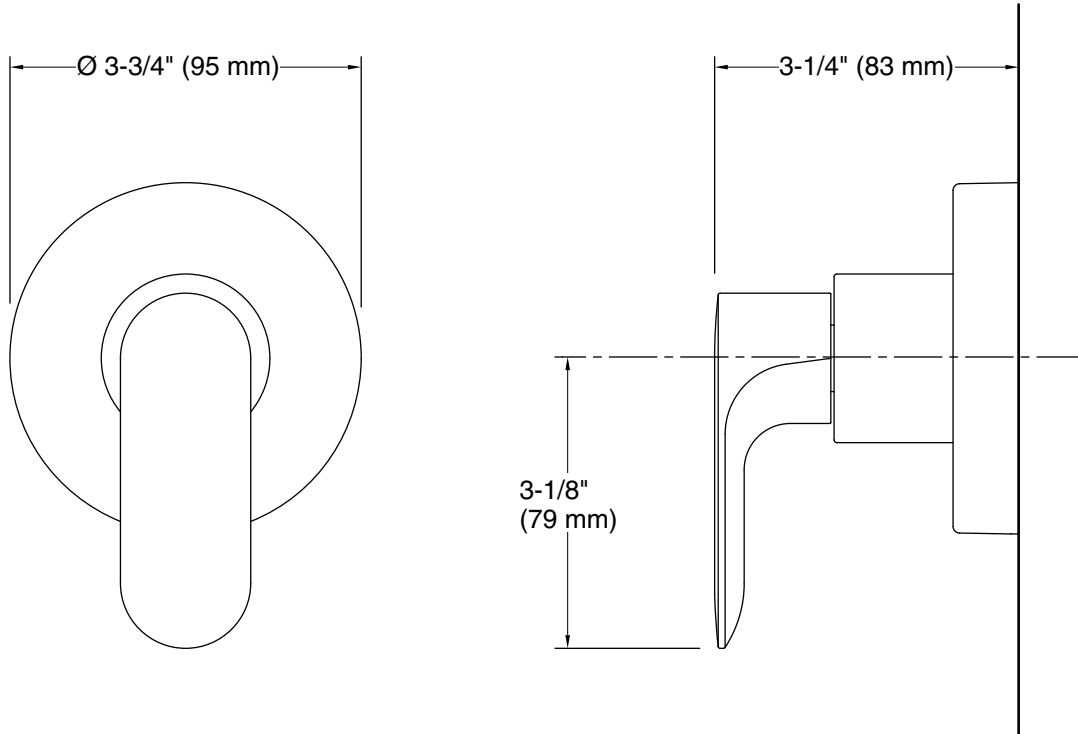

## Technical Information

All product dimensions are nominal.

## Notes

Install this product according to the installation instructions.

ADA, OBC, CSA B651 compliant when installed to the specific requirements of these regulations.