

Features

- High-quality solid metal construction for durability and reliability

Installation

- Includes hex wrench for installation

Recommended Products/Accessories

- P34120-LV Widespread Sink Faucet, Tall Spout, Lever Handles
- P34136-00 Towel Bar, 18"
- P34137-00 Towel Bar, 24"
- P34139-00 002™ Hook
- P34141-00 Toilet Paper Holder



Codes/Standards







None Applicable

KALLISTA® Five-Year Limited Warranty

See website for detailed warranty information.

Available Colors/Finishes

Color tiles intended for reference only.

Color	Code	Description
	CP	Polished Chrome
	BL	Matte Black
	BN	Brushed Nickel
	SN	Polished Nickel
	BAF	Brushed French Gold
	2MB	Brushed Moderne Brass

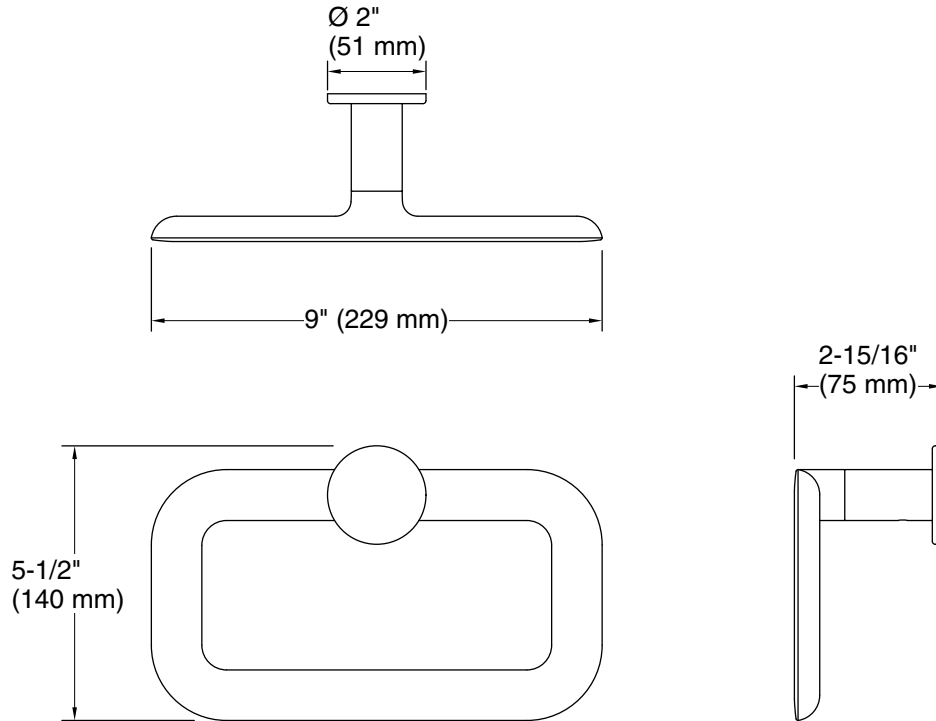

Technical Information

All product dimensions are nominal.

Material: Brass, Zinc

Notes

Install this product according to the installation instructions.