

KALLISTA®

Central Park West® by Robert A.M. Stern
Architects

Swing Spout Widespread Faucet, Arch Spout,
Lever Handles
P35496-LV

Features

- High-quality solid-brass construction for durability and reliability
- Three-hole installation
- 1.8 gpm (6.8 lpm) maximum flow rate
- 360-degree swing spout
- Sink strainer with tailpiece sold separately

Recommended Products/Accessories

P35501-00 Sidespray
P35507-LV Drinking Faucet, Arch Spout
P34014-00 Air Gap Body With Cover
L39742-00 36" Apron Front Kitchen Sink
P35503-LV Bar Faucet

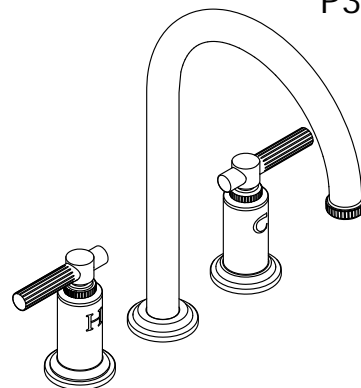

ADA

CSA B651

Codes/Standards







ASME A112.18.1/CSA B125.1
NSF/ANSI/CAN 61
NSF/ANSI/CAN 372
DOE - Energy Policy Act 1992
California Energy Commission (CEC)
ADA
ICC/ANSI A117.1
CSA B651

KALLISTA® Five-Year Limited Warranty

See website for detailed warranty
information.

Available Colors/Finishes

Color tiles intended for reference only.

Color	Code	Description
	CP	Polished Chrome
	ULB	Unlacquered Brass
	BGP	Brushed Graphite
	BAF	Brushed French Gold
	VS	Stainless
	SN	Polished Nickel
	2MB	Brushed Moderne Brass

1-888-4-KALLISTA (1-888-452-5547)

Kallista reserves the right to make revisions without notice to product specifications.

For the most current Specification Sheet, go to www.kallista.com.

6-15-2026 20:21 - US/CA

KALLISTA

Central Park West® by Robert A.M. Stern
Architects

Swing Spout Widespread Faucet, Arch Spout,
Lever Handles

P35496-LV

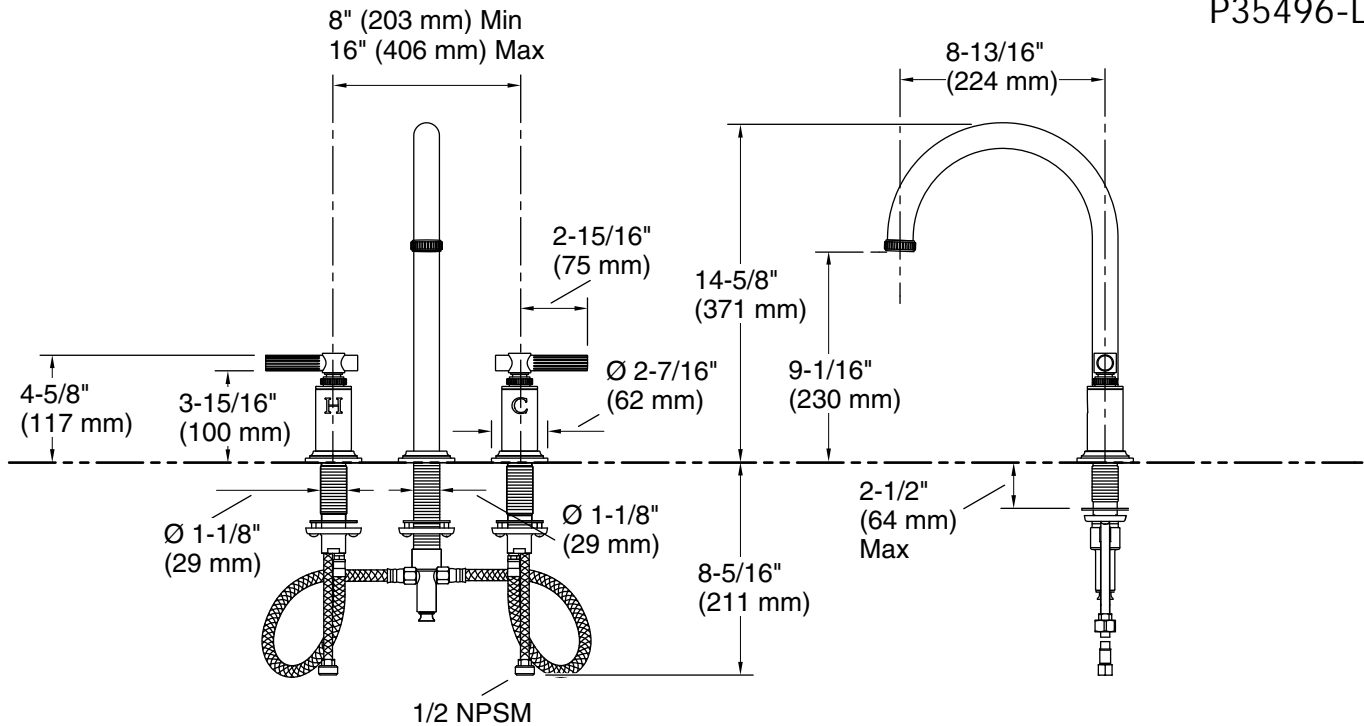

Technical Information

All product dimensions are nominal.

Faucet flow rate: 1.8 gal/min (6.8 l/min)

Spout:

Spout reach: 8-13/16" (224 mm)

Notes

Install this product in accordance with the installation instructions.

ADA compliant for faucet handles only
ADA, CSA B651 compliant when installed to the specific requirements of these regulations.