

KALLISTA®

Central Park West® by Robert A.M. Stern Architects Gentleman's Bar Faucet, Tall Spout, Lever Handle P35502-LV

Features

- High-quality solid-brass construction for durability and reliability
- Single-hole installation
- 360-degree swing spout
- 1.5 gpm (5.7 lpm) maximum flow rate
- Single-handle control
- Sink strainer with tailpiece sold separately

Recommended Products/Accessories

- P35495-LV Deck-Mount Bridge Faucet, Tall Spout, Lever Handles
- P35506-LV Wall-mount Kitchen Pot Filler
- P35508-LV Drinking Faucet, Tall Spout
- L39743-00 24" Apron-front Butler Sink
- L20308-00 18" Bar Sink

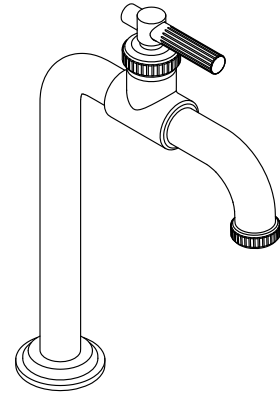

Codes/Standards







- ASME A112.18.1/CSA B125.1
- NSF/ANSI/CAN 61
- NSF/ANSI/CAN 372
- DOE - Energy Policy Act 1992
- California Energy Commission (CEC)

KALLISTA® Five-Year Limited Warranty

See website for detailed warranty information.

Available Colors/Finishes

Color tiles intended for reference only.

Color	Code	Description
	CP	Polished Chrome
	ULB	Unlacquered Brass
	SN	Polished Nickel
	2MB	Brushed Moderne Brass
	BGP	Brushed Graphite
	VS	Stainless
	BAF	Brushed French Gold

1-888-4-KALLISTA (1-888-452-5547)

Kallista reserves the right to make revisions without notice to product specifications.

For the most current Specification Sheet, go to www.kallista.com.

5-18-2026 23:15 - US/CA

KALLISTA

Central Park West[®] by Robert A.M. Stern
Architects

Gentleman's Bar Faucet, Tall Spout, Lever Handle

P35502-LV

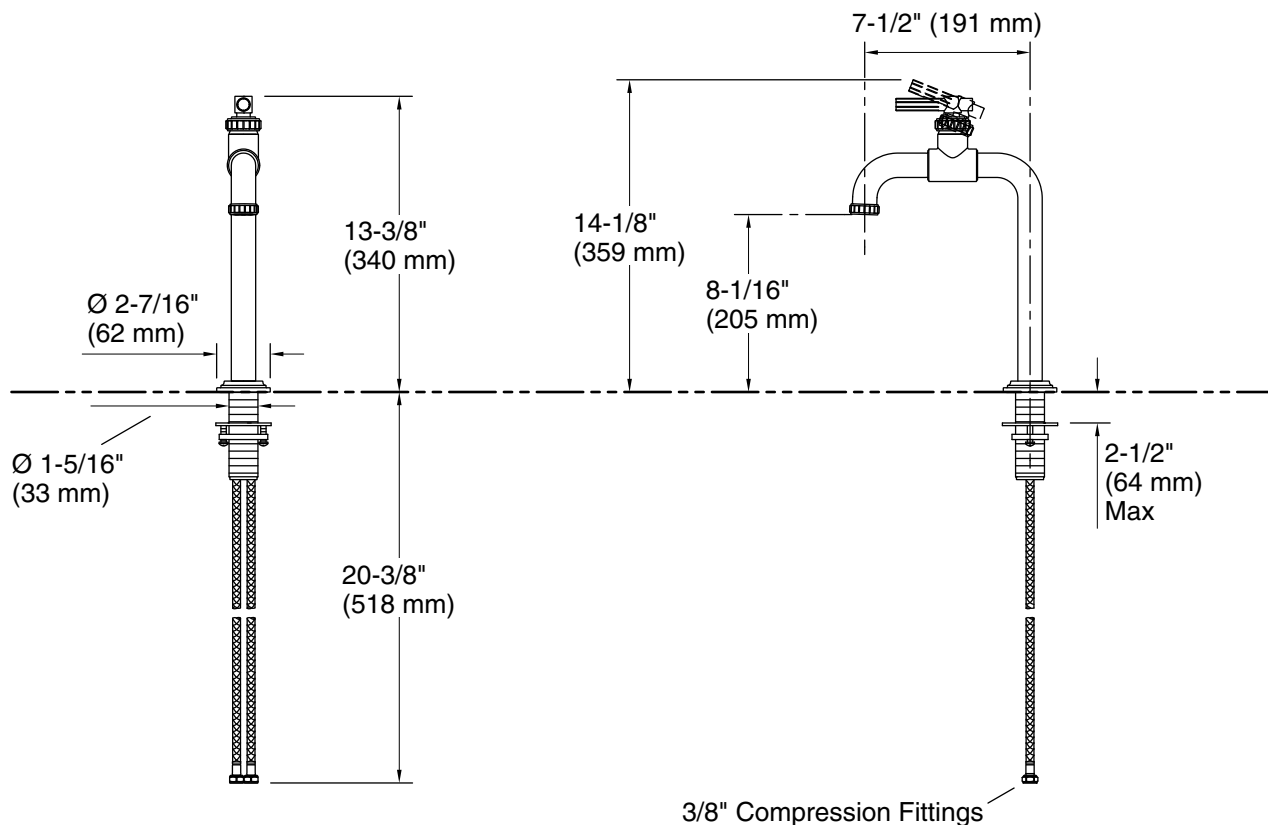

Technical Information

All product dimensions are nominal.

Faucet flow rate: 1.5 gal/min (5.7 l/min)

Spout:

Spout reach: 7-1/2" (191 mm)

Notes

Install this product according to the installation guide.