

KALLISTA®

Central Park West® by Robert A.M. Stern Architects

Bar Faucet P35503-LV

Features

- High-quality solid-brass construction for durability and reliability
- Single-hole installation
- 360-degree swing spout
- 1.5 gpm (5.7 lpm) maximum flow rate
- Single-handle control
- Sink strainer with tailpiece sold separately

Recommended Products/Accessories

P35496-LV Swing Spout Widespread Faucet, Arch Spout, Lever Handles

P35506-LV Wall-mount Kitchen Pot Filler

L39743-00 24" Apron-front Butler Sink

L20308-00 18" Bar Sink

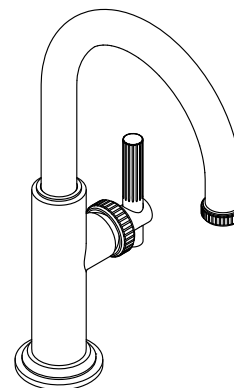

ADA

CSA B651

Codes/Standards

ASME A112.18.1/CSA B125.1

NSF/ANSI/CAN 61

NSF/ANSI/CAN 372

DOE - Energy Policy Act 1992

California Energy Commission (CEC)

ADA

ICC/ANSI A117.1







CSA B651

KALLISTA® Five-Year Limited Warranty

See website for detailed warranty information.

Available Colors/Finishes

Color tiles intended for reference only.

Color	Code	Description
	CP	Polished Chrome
	ULB	Unlacquered Brass
	BAF	Brushed French Gold
	SN	Polished Nickel
	VS	Stainless
	2MB	Brushed Moderne Brass
	BGP	Brushed Graphite

1-888-4-KALLISTA (1-888-452-5547)

Kallista reserves the right to make revisions without notice to product specifications.

For the most current Specification Sheet, go to www.kallista.com.

6-15-2026 20:20 - US/CA

KALLISTA

Central Park West® by Robert A.M. Stern
Architects
Bar Faucet
P35503-LV

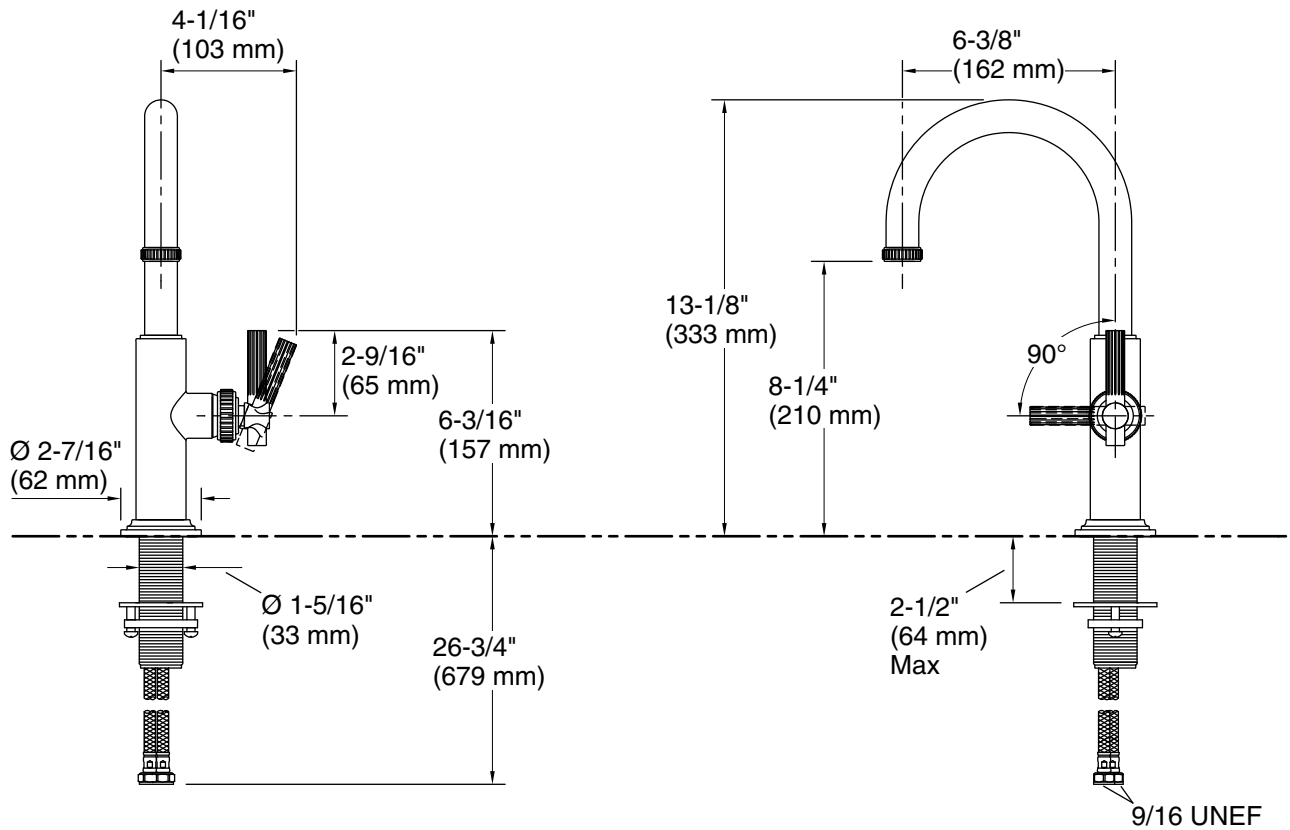

Technical Information

All product dimensions are nominal.

Faucet flow rate: 1.5 gal/min (5.7 l/min)

Spout:

Spout reach: 6-3/8" (163 mm)

Notes

Install this product according to the installation instructions.

ADA compliant for faucet handles only
ADA, CSA B651 compliant when installed to the specific requirements of these regulations.