

KALLISTA®

Aileron™ by CRISTINA RubINETterie Aileron™ Stacked 2-Outlet Thermostatic Trim, Lever Handle P39847-LV

Features

- Lever handle
- High-quality solid-brass construction for durability and reliability
- Intricate knurling detail
- Thermostatic and diverting functions on one trim plate
- Eco-friendly diverter easily switches water flow from one function to another
- Precise temperature setting capability
- Button activation required for temperatures between 100° – 107°F (37.7° – 41.6°C)
- High temperature limit button
- Required rough-in sold separately

Required Products/Accessories

For wall-mount installation

P32999-00 Stacked Thermostatic Shower Trim Rough In

Recommended Products/Accessories

P32939-00 Modern Round Showerhead with Arm

P32964-00 Modern Round Handshower with Hose

P33386-00 Modern Round Wall Bracket with Integrated Supply

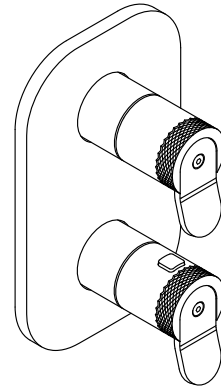

ADA

CSA B651

OBC

Codes/Standards

ASME A112.18.1/CSA B125.1

ADA

ICC/ANSI A117.1

CSA B651





OBC

KALLISTA® Five-Year Limited Warranty

See website for detailed warranty information.

Available Colors/Finishes

Color tiles intended for reference only.

Color	Code	Description
	CP	Polished Chrome
	BL	Matte Black
	BLH	Blush Brass
	BN	Brushed Nickel
	2MB	Brushed Moderne Brass
	BGP	Brushed Graphite

1-888-4-KALLISTA (1-888-452-5547)

Kallista reserves the right to make revisions without notice to product specifications.

For the most current Specification Sheet, go to www.kallista.com.

4-5-2026 19:36 - US/CA

KALLISTA®

Aileron™ by CRISTINA Rubinetterie Aileron™ Stacked 2-Outlet Thermostatic Trim, Lever Handle P39847-LV

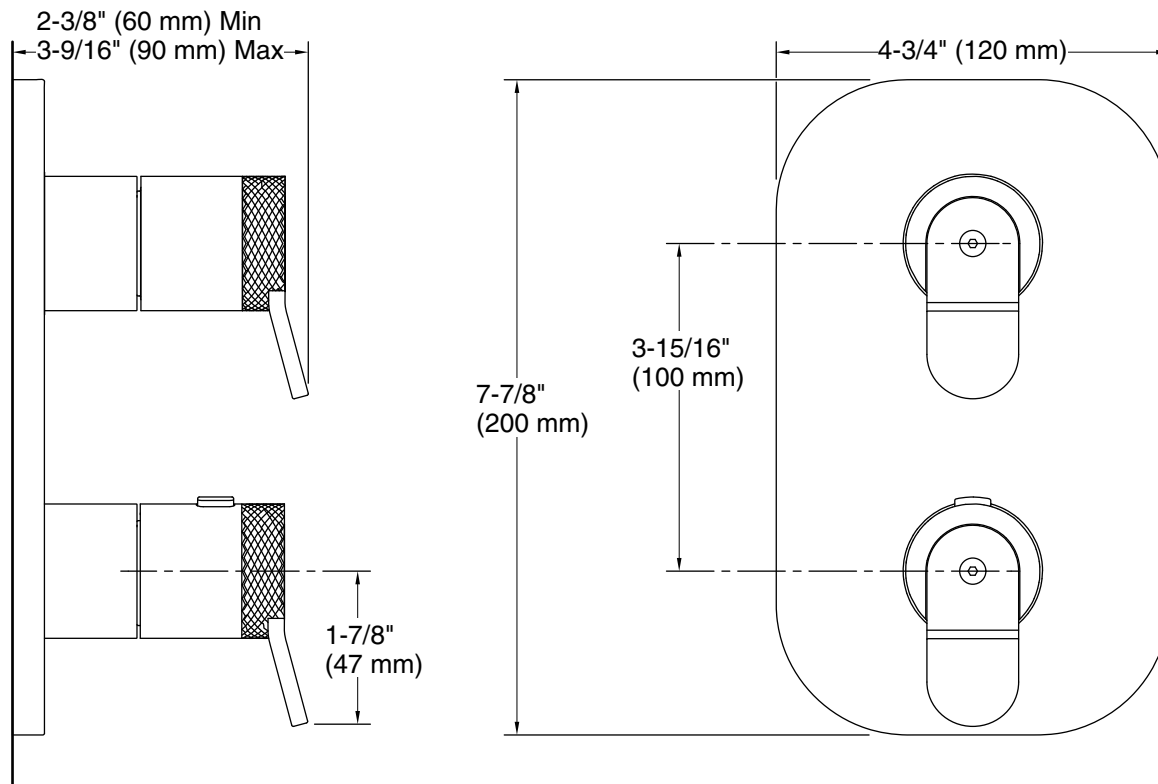

Technical Information

All product dimensions are nominal.

Notes

Install this product according to the installation instructions.

ADA, OBC, CSA B651 compliant when installed to the specific requirements of these regulations.