

# KALLISTA®

One™ by KALLISTA  
Thermostatic trim, Armory handle  
P40881-LV

## Features

- Sleek contemporary design
- Solid metal construction for durability and reliability
- Precise temperature setting capability
- Required rough-in sold separately

## Required Products/Accessories

P29511-WS 1/2" Thermostatic Mixing Valve

or

P29512-WS 3/4" Thermostatic Mixing Valve



**ADA**

**CSA B651**

**OBC**

## Codes/Standards

ASME A112.18.1/CSA B125.1

ADA

ICC/ANSI A117.1

CSA B651







OBC

## KALLISTA® Five-Year Limited Warranty

See website for detailed warranty  
information.

## Available Colors/Finishes

*Color tiles intended for reference only.*

Color	Code	Description
	CP	Polished Chrome
	BL	Matte Black
	BAF	Brushed French Gold
	BN	Brushed Nickel
	SN	Polished Nickel
	2MB	Brushed Moderne Brass

---

1-888-4-KALLISTA (1-888-452-5547)

Kallista reserves the right to make revisions without notice to product specifications.

For the most current Specification Sheet, go to [www.kallista.com](http://www.kallista.com).

2-15-2025 22:04 - US/CA

# KALLISTA

One™ by KALLISTA  
Thermostatic trim, Armory handle  
P40881-LV

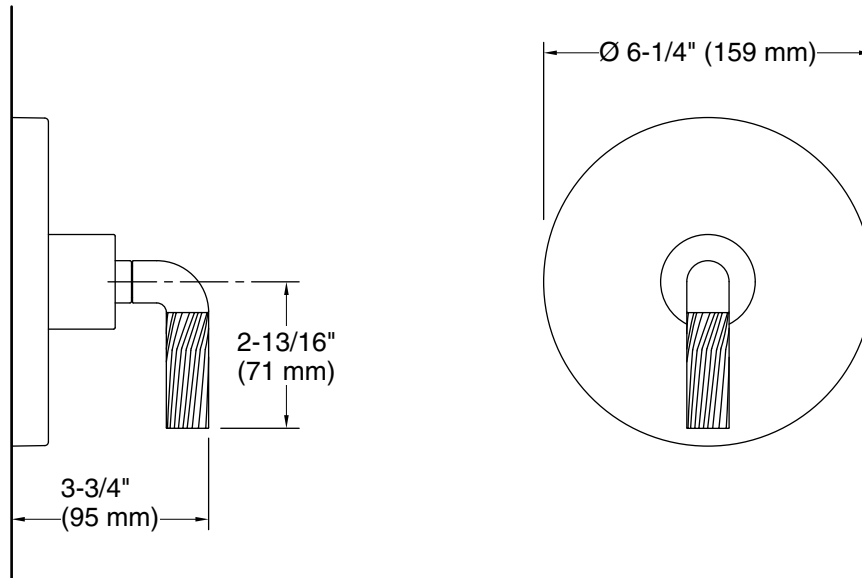

## Technical Information

All product dimensions are nominal.

Drain included: No

## Notes

Install this product according to the installation instructions.

ADA, OBC, CSA B651 compliant when installed to the specific requirements of these regulations.