

Features

- Metal Framed Mirrored Cabinet
- All cabinets are non-handed/reversible
- Mirrored interior with 4 adjustable, cantilevered glass shelves
- Cantilever shelving adjustable in 1" increments
- Includes installation hardware for recess mounting
- Can be recessed or surface mounted (surface mounting kit required)
- Blum 155° slow close hinges

Optional Features & Upgrades

- PORTRAY Quick Caddy (QUICKCADDY)
- PORTRAY Electric Upgrade (P2ELECTRIC)
- Other widths/heights available: 24" wide, 40" high
- Glass Bins (GLASSBIN3.25, GLASSBIN5.25, GLASSBIN8.5)

Construction

- Rust free Satin anodized aluminum construction
- Blum hinges standard
- 3 mirror design - rear of cabinet and both sides of door

Codes/Standards Applicable

- Electric Option Models are ETL certified to:
 - UL 962
 - CSA Standard C22.2 No. 68

Dimensions

Width: 19-1/4" (489 mm)
 Height: 34-1/4" (870 mm)
 Depth: 4-3/4" (121 mm) When surface mounted
 1-1/16" (26 mm) When recessed

Installation Options

Recessed Mount - Rough Opening - 18-1/2" W x 29-1/4" H x 4" D (470 mm W x 743 mm H x 102 mm D)

Surface Mount (Single Cabinet) - Reference Surface Mount Kit when ordering (P2SMKIT)

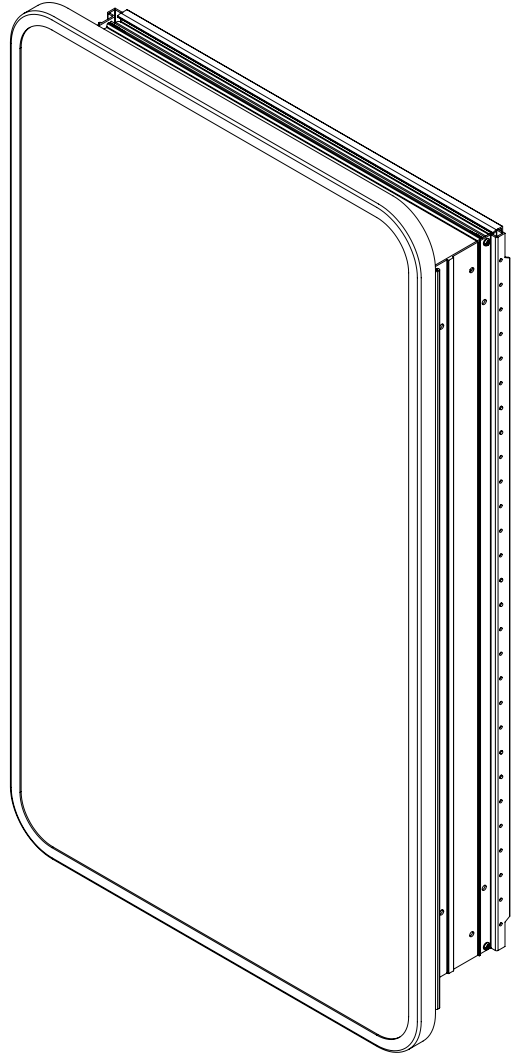

Model Number Key

Craft Cabinet Series	Width	Height	Depth	Frame Style	Frame Finish	Package Option
CC	20	34	D4	RC = Round Corner Metal	83 = Matte Black 84 = Polished Stainless Steel 87 = Aged Brass	SC = Slow Close TU = Slow Close, Electric Upgrade

Electrical System

- 120 VAC 60HZ 20A
- Field wire location as shown in drawing
- 1/2" conduit (Ø 7/8" actual) electrical knockout location shown below

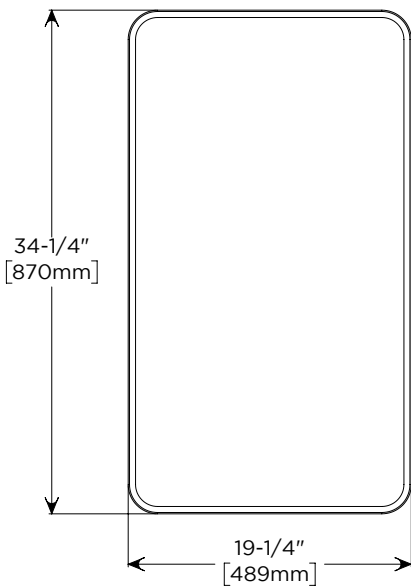
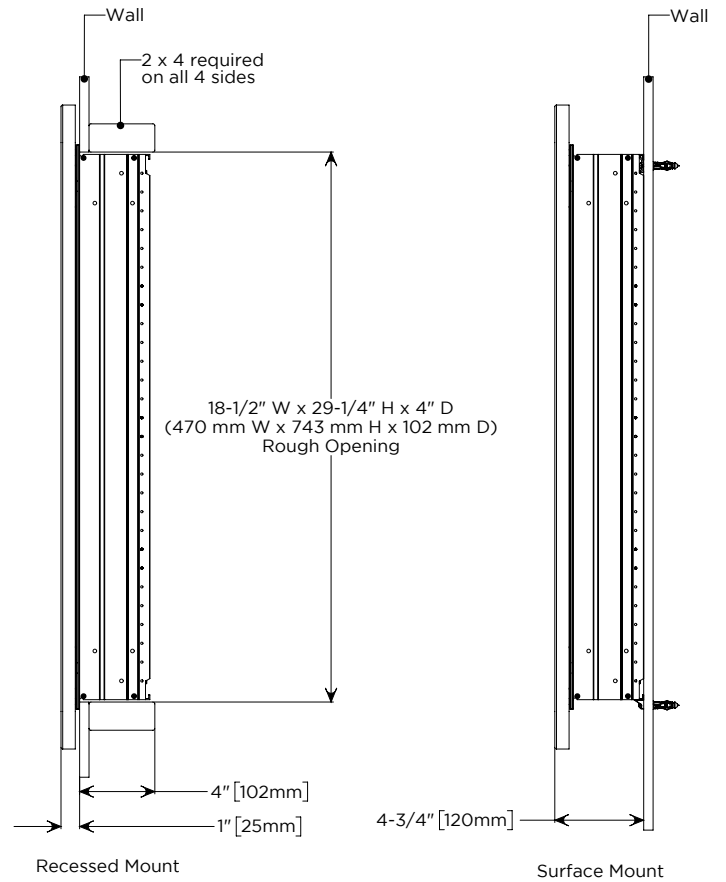

Cabinet Dimensions

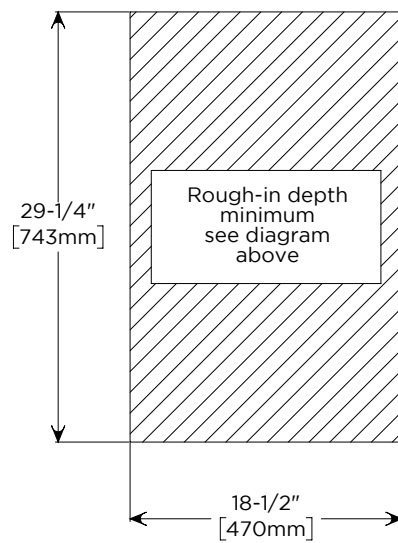

Rough-in Dimensions

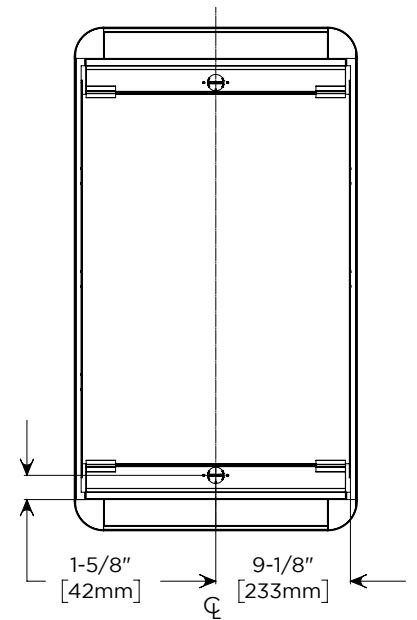

Back of Cabinet - Wire Access Location