



Rite-Temp® bath and shower faucet trim set, 1.75 gpm TS24820-4G

Valton®

Features

- A single handle controls both on/off activation and temperature setting
- Antiscald protection
- Single-function 1.75 gpm (6.6 lpm) showerhead with Katalyst® air-induction technology
- MasterClean™ sprayface features an easy-to-clean surface that withstands mineral buildup and maximizes spray performance
- 5-1/16" (129 mm) diverter bath spout with slip-fit connection
- Includes faceplate with ADA-compliant metal lever handle
- Coordinates with other products in the Valton collection
- Pressure-balancing diaphragm technology maintains outlet temperature within +/-3°F during water pressure fluctuations



Material

- Premium metal construction for durability and reliability
- KOHLER finishes resist corrosion and tarnishing

Installation

- Wall-mount
- Trim only; requires valve to complete installation (sold separately)

Required Products/Accessories

K-8304 Series Rite-Temp® Valve & Cartridge Kits

Optional Products/Accessories

- K-10350 Deep rough-in kit
- K-10351 Test cap for K-8300 Series valve bodies



Codes/Standards

- ASME A112.18.1/CSA B125.1
- DOE - Energy Policy Act 1992
- EPA WaterSense®
- California Energy Commission (CEC)

STERLING® Faucet Lifetime Limited Warranty

See website for detailed warranty information.

Available Colors/Finishes

Color tiles intended for reference only.

Color	Code	Description
	CP	Polished Chrome

1-800-STERLING (1-800-783-7546)

Kohler Co. reserves the right to make revisions without notice to product specifications.

For the most current Specification Sheet, go to www.sterlingplumbing.com.

9-21-2025 10:10 - US/CA

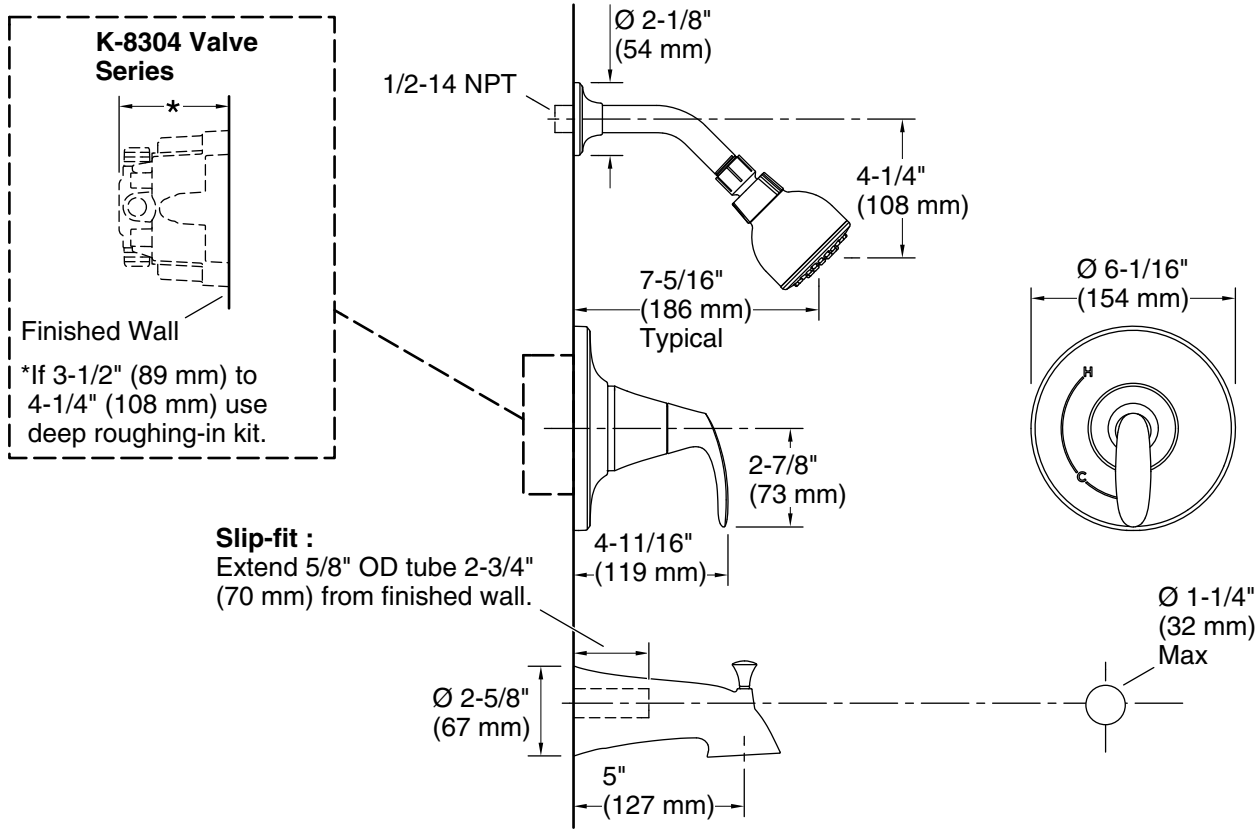

Technical Information

All product dimensions are nominal.

Faucet flow rate: 1.75 gal/min (6.6 l/min)

Spout:

Spout reach: 5-1/16" (128 mm)

Shower/Rainhead rated max flow: 1.75 gal/min (6.6 l/min)

Notes

Install this product according to the installation instructions.