

Deck-Mount Diverter With Handspray

14399T 72636T 缸边式花洒及切换器

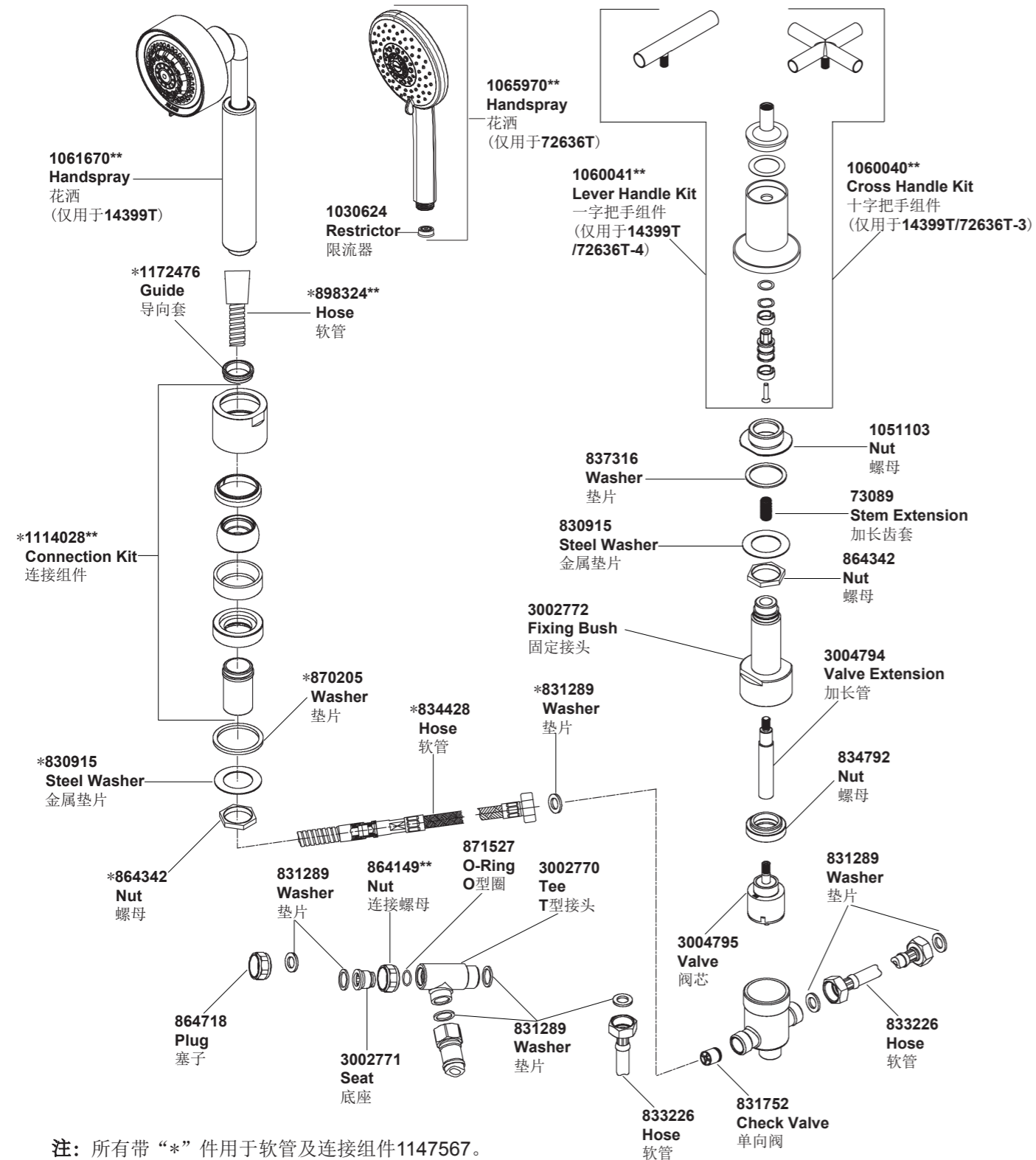

注：所有带“*”件用于软管及连接组件1147567。

**订购时请说明颜色编号

**Color code must be specified when ordering

Deck-Mount Diverter With Handspray

14399T 72636T 缸边式花洒及切换器

安装之前

所有的资料是按最新出版的产品资料编写而成。科勒公司保留任何时候不经通知即可改变产品特性、包装或产品可供类型的权利。

说明书包括重要的安装、保养及清洁方面的内容，请把这些资料交给用户阅读。

注意事项：

1. 切断主供水源。
2. 在安装前，仔细阅读说明书的全部内容。
3. 遵守当地管路安装条例。
4. 该龙头只具有切换功能，它必须与有冷热控制开关的浴缸龙头配合使用。

5. 花洒最高工作压力：0.5MPa(5bar)。水压超过0.5MPa(5bar)须安装减压阀。花洒最高工作温度及环境温度：60°C。请特别注意花洒同花洒连接的臂管须远离浴霸，否则可能损坏花洒及其密封件，甚至对使用者造成伤害。

使用说明

顺时针旋转切换把手浴缸出水口出水，逆时针旋转切换把手手持花洒出水。

安装尺寸

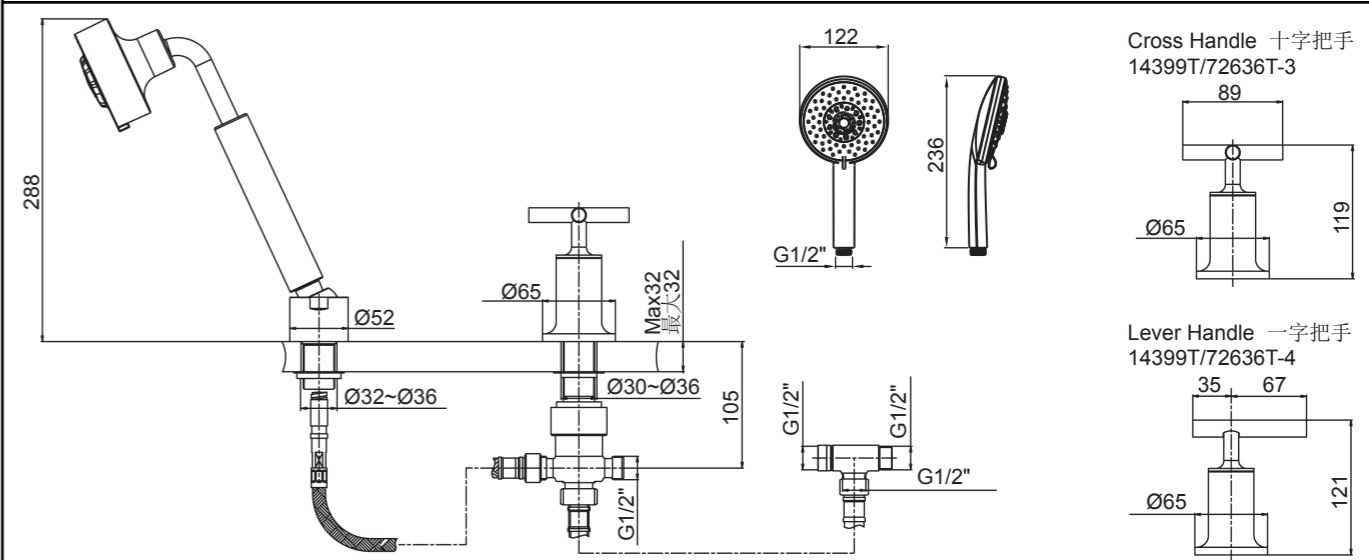

BEFORE YOU BEGIN

All information is based on the latest product information available at the time of publication. Kohler Co. reserves the right to make changes in product characteristics, packaging, or availability at any time without notice. Please leave these instructions for the consumer. They contain important information.

NOTES:

1. Shut off the main water supply.
2. Carefully read entire instructions before beginning installation.
3. Observe local plumbing codes.
4. This faucet has switching function only. It must work with a bath faucet(purchased separately) that has both on/off and hot/cold mixing control.
5. The highest working pressure for handspray is 0.5MPa(5bar). If it exceeds 0.5MPa(5bar), a pressure reducer is needed. The highest water and environment temperature is 60°C. Please keep handspray, showerhead and the shower arm away from heater, or it may become damaged and cause injury to the user.

HANDLE OPERATION

Turn diverter handle clockwise for the bath spout, turn counter-clockwise for the handspray.

ROUGH-IN DIMENSIONS

安装步骤

如何安装T型接头

将垫片(2)放入T型接头(4)的螺母(3)内后, 将T型接头(4)接到用户所选配浴缸龙头的一侧阀体(1)上, 如图所示。

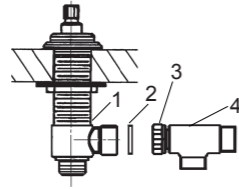

如何安装切换阀体

从切换器组件(9)上旋下螺母(5)。将带有垫片(7)和螺母(8)的切换器组件从台面的下方插入安装孔。从上方套上橡胶垫片(6), 旋上螺母(5)。用扳手锁紧螺母(8)。

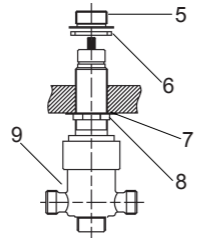

把齿套(11)装到齿柄(12)上, 将把手组件(10)旋到切换器组件(9)上, 直到与台面接触。

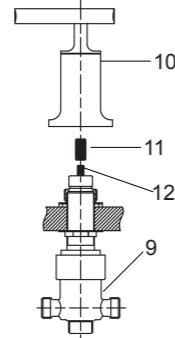

如何安装花洒

拆下螺母(15)、垫片(14), 将橡胶垫片(13)置于导向套组件(16)底面凹槽内。将牙管插入安装孔。并从下方将垫片(14)、螺母(15)安装到牙管上, 拧紧螺母。

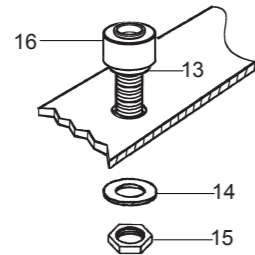

将花洒软管(20)(长2m)穿过导向套组件连接到连接软管(17)(长0.6m)上。

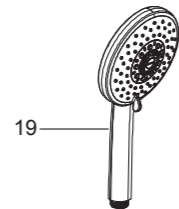

将垫片(18)放入花洒软管(20)接头内, 将花洒软管旋接到手持花洒(19)。

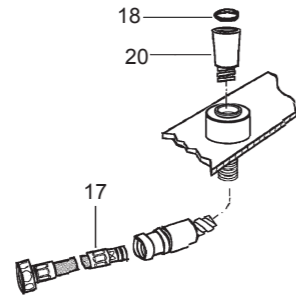

INSTALLATION

How To Install The Tee

Put the washer(2) into the nut(3) of the tee(4). Then connect the tee(4) to one side body(1) of the deck-mount bath faucet as the figure shown.

How To Install Diverter Body

Unscrew nut(5) from the diverter body (9). Insert the diverter body with washer (7) and nut(8) through mounting hole from underside of the deck. Put rubber washer(6) onto diverter body. Reinstall the nut(5). Wrench tighten the nut(8).

Put the extension stem(11) onto the valve extension adapter(12). Thread the handle kit(10) to the diverter body (9) until it contacts the deck or bath tub rim.

How To Install The Handspray

Remove the nut(15), washer(14). Put the rubber washer(13) into the groove of the hose guide kit(16). Place the shank into the mounting hole. From underside, install the washer(14) and nut(15) to the shank. Then tighten the nut firmly.

Slide the shower hose(20)(length: 2m) through the hose guide kit, and attach to the connection hose(17)(length: 0.6m).

Put the washer(18) into the shower hose(20) connector. Thread the shower hose onto handspray(19).

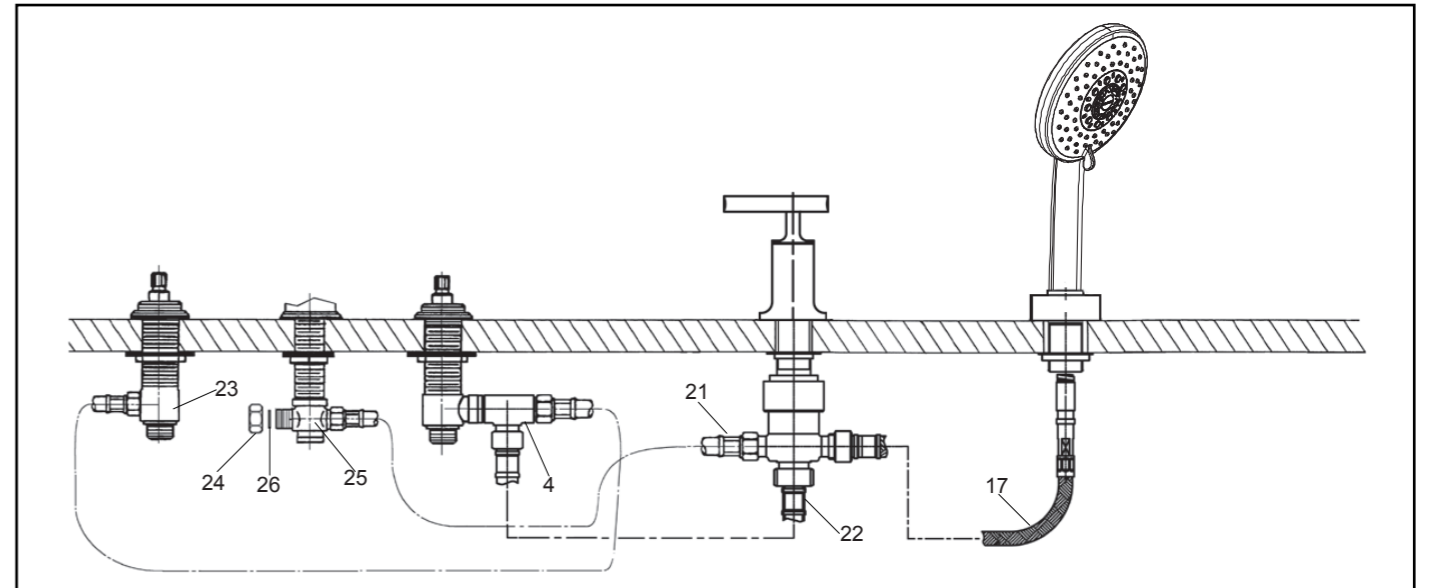

把垫片(26)放入螺母(24), 并将其旋到所选配浴缸龙头出水口的T型接头(25)的任意端口上锁紧。

Put the fiber washer(26) into the plug(24), Tighten the plug to one of the ports of the center tee(25) for the spout.

用垫片及随浴缸龙头附带的一根软管(龙头附带的另一软管去掉不用)连接一侧阀体(23)和另一侧阀体的T型接头(4)。用软管(22)(长1m)及垫片连接T型接头(4)和切换器底部接口。用垫片连接软管(17)及切换器花洒接口(贴有提示签的一端)。用软管(21)(长1m)及垫片连接出水口T型接头(25)和切换器的另一出水口。

Connect one side body(23) and the tee(4) on another side body with washers and one of the hoses provided with the bath faucet(Remove another hose and put it away). Connect the tee(4) and bottom port of the diverter with hose(22)(length:1m) and washers. Tighten the connection hose(17) to the port(with note label) of the diverter with washer. Connect the center tee(25) and another port of the diverter with hose(21) (length:1m) and washers.

为保证水流顺畅, 花洒抽取自如, 应该避免软管打结、缠绕。为了安装方便, 可以适当旋松出水口的T型接头, 但不要超过180°。

To ensure the water flows smoothly and the hand-spray can be drawn out easily, the hose should avoid kinking, twisting. To ease installation, you may back off center tee of the spout up to 180 degree.

注意: 软管只能用于指定部位。

Note: Hoses should only be used where defined.

安装结果检查

确保所有连接螺母都已拧紧。打开主供水源, 检查并修理有漏水的接口。

INSTALLATION CHECKOUT

Ensure all coupling nuts are tight. Turn on main water supply and check for leaks. Repair as required.

清理说明

适用于所有加工处理过的表面: 以中性肥皂水清洗镀层表面, 再以干净的软布彻底擦干整个表面, 许多清洁剂, 比如氨水、去污粉及洁厕灵等, 会对电镀表面造成伤害, 切忌使用。

有磨损性的清洁用具或清洁剂也不可适用于科勒牌的水龙头及其配件上。

CLEANING INSTRUCTIONS

All Finishes: Clean the finish with mild soap and warm water. Wipe entire surface completely dry with clean soft cloth. Many cleaners may contain chemicals, such as ammonia, chlorine, toilet cleaner etc. which could adversely affect the finish and are not recommended for cleaning.

Do not use abrasive cleaners or solvents on Kohler faucets and fittings.