

K-2949T 拂朗 FOREFRONT



釉面陶瓷台下式脸盆 VITREOUS CHINA UNDERCOUNTER LAVATORY 切割图/安装说明书 CUT-OUT TEMPLATE / INSTALLATION INSTRUCTIONS



安装之前

- 有关安装专业性质的，故台下或脸盆必须经由受过训练及有经验的技师进行安装。
- 切勿在本品上使用密封胶或有粘性的密封胶。
- 检查出水及供水管道，如有需要便更换。
- 安装之前先开启新脸盆的包装，检查有无损坏后放回纸箱中以免损坏，到准备安装时才取出。
- 遵守当地所有给排水及建筑规定。
- 科勒洗脸盆是根据美国标准制造的，与美式洗脸盆配件相配，其它洗脸盆配件可能与之不相配。

BEFORE YOU BEGIN

- Due to the nature of the installation, undercounter lavatories should be installed by trained and experienced installers.
- Do not use adhesives or adhesive sealants with this product.
- Inspect the waste and supply tubing; replace if necessary.
- Prior to installation, unpack the new lavatory and inspect it for damage. Return the lavatory to its protective carton until you are ready to install it.
- Observe all local plumbing and building codes.
- Kohler lavatory is made according to American National Standard that it can match the American lavatory fittings. Any other lavatory fittings may not fit for Kohler lavatory.

所需的工具和物料

- 密封胶
- 软性铅笔
- 卷尺
- 尖刀或剪刀
- 匙孔线锯或手提电锯
- 钻(直径13毫米或者更大的钻头)
- 护眼镜
- 锤子
- 抹布或者纸质毛巾

TOOLS AND MATERIALS

- Sealant
- Pencil
- Tape measure
- Sharp knife or scissors
- Keyhole or saber saw
- Drill (13mm dia. drill bit or larger)
- Safety glasses
- Hammer
- Rags or paper toweling

尺寸图

Reference Value
参考值

ROUGHING-IN

Unit: mm
单位: 毫米

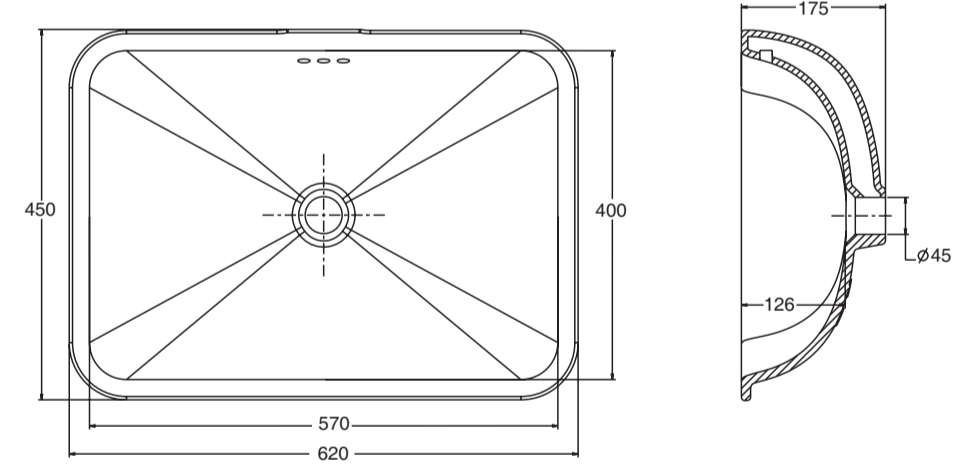

科勒公司保留随时变更图中标示尺寸的权利，无需另行通知。
Kohler reserves the right to change marked dimensions without prior notice.

安装脸盆

- 注意：安装中要允许将来可以从盥洗台面之下进行拆取，以免台面损坏。
- 检查准备装上脸盆的位置，是否与防溅挡板、水龙头、脸盆及储物柜保持足够的距离。
 - 剪出模板。
 - 将模板小心放置于台上，并在台面上按照模板画出其边缘轮廓导线。
 - 在盥洗台上标出水龙头孔位的中心线。
 - 在切线内侧钻出一个13毫米的导孔。
 - 用匙孔线锯或者手提电锯切开盥洗台面。

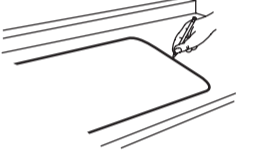

木制盥洗台面

- 按照模板所示的位置，在台面上标出及预先钻木螺钉的孔位。
- 其它外露的木质表面需要保持防水。

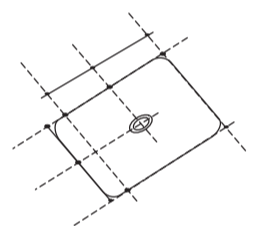

大理石盥洗台面

- 将大理石盥洗台面倒过来放在泡沫上以保护其表面，按照模板所示的位置钻要各个直径为10毫米深为16毫米的孔位。
- 利用安装工具及锤子来固定铅锚。

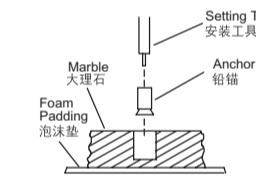

对所有台面的安装

- 如果还没有安装盥洗台，请在这时安装。
- 按照水龙头安装说明，钻出水龙头孔。
- 按照制造商的说明书，在盥洗台上安装水龙头。
- 按照制造商的说明书，在脸盆下安装排水管。
- 注意：请勿在本品上使用密封胶或者有粘性的密封胶。
- 在与盥洗台接触的的脸盆边缘上，如珠串般连续涂上优质密封胶。
- 注意：随附的螺钉只适用于最小25毫米厚的盥洗台，而较薄的盥洗台则需要其它合适的铅锚和钉。
- 在木质、木质合成物及大理石的盥洗台上安装脸盆时，可以使用随附的夹具和螺钉。其它物料制造的盥洗台，则请参阅盥洗台制造商的说明书上所作的说明，使用适当的扣件。
- 在上紧夹具前，先将脸盆平整地放置在盥洗台切口下，然后小心地将脸盆拉起直至合度才可以上夹具，切勿上得太紧。
- 立即擦去多余的密封胶。
- 最后将所有的水管和水龙头与脸盆连接妥当，确保安装符合随附的所有水管和龙头说明书。
- 使用非腐蚀性的清洁剂进行清洁。

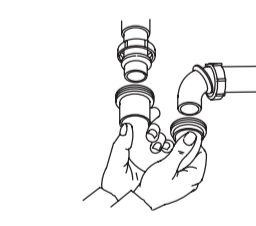
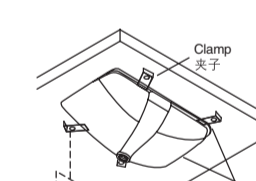
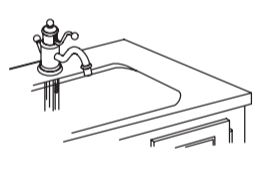

注意：采用此切割模板切割的台面内沿到面盆内边缘的距离为6mm左右，客户可根据需要按比例缩放用以切割台面。

INSTALL THE LAVATORY

- NOTE: Install so future removal from underneath the countertop is possible to avoid damage to the countertop.
- Check the desired lavatory location for clearance between the backsplash, faucet, fixture, and cabinet.
 - Cut out the template.
 - Carefully position and trace the template on the countertop as directed on the template.
 - Mark the faucet hole centerline on the countertop.
 - Drill a 13mm pilot hole on the inside of the cut line.
 - Cut out the countertop opening with a saber or keyhole saw.

FOR WOOD COUNTERTOPS

- Mark and pre-drill the wood screw holes at the locations shown on the template.
- Waterproof any exposed areas of wood.

FOR MARBLE COUNTERTOPS

- Position the countertop upside down on foam padding to protect the surface. Mark and drill 10mm holes 16mm deep at the locations shown on the template.
- Use a setting tool and hammer to secure the anchors.

FOR ALL INSTALLATIONS

- If the countertop has not been installed, install it at this time.
- Drill the faucet holes according to the faucet installation instructions.
- Install the faucet to the countertop according to the manufacturer's instructions.
- Install the drain to the lavatory according to the manufacturer's instructions.

NOTE: Do not use adhesives or adhesive sealants.

- Apply a continuous bead of quality sealant to the lavatory rim where it will contact the countertop.

- NOTE: The screws provided should be used on countertops with a minimum 25mm thickness. For thinner countertops, use appropriate anchors and fasteners.
- For wood, wood composite, and marble countertops, install the lavatory to the countertop with the clamps and screws provided. For other countertop materials, refer to the countertop manufacturer's instructions for recommended fasteners.

- Position the lavatory squarely under the cutout before tightening the clamps. Draw the lavatory rim up to the countertop until it is snug. **Do not overtighten.**
- Immediately wipe away any excess sealant.
- Make the final drain and faucet connections to complete the lavatory installation. Be sure to follow all instructions packed with the drain and faucet.
- Clean up with a **non-abrasive** cleaner.

NOTE: Using this template, the overhang is about 6mm. Customers can zoom the template by scale to meet their requirement.

用户须知 (护理和清洁)

- 为保持脸盆光洁如新，须确保每次使用后彻底冲洗干净，切勿使用腐蚀性的清洁剂，以免刮花及破坏脸盆的表面。要清除顽固污垢、油漆或柏油，可使用松油或油漆稀释剂。
- 不要在0°C以下的水环境中使用。
- 请勿使用钢丝球等硬质材料擦洗产品表面，特别是产品商标处。

IMPORTANT CONSUMER INFORMATION (CARE AND CLEANING)

- To keep your lavatory looking new, make sure you rinse it out thoroughly after each use. **DO NOT USE ABRASIVES** on this product, as they will scratch and ruin the surface. Stubborn stains, paint, or tar can be removed with turpentine or paint thinner.
- Do not use the product in the water below 0°C.
- Please do not use hard materials (like scouring pad) to clean product surface, especially the product logo.

维修零件

SERVICE PARTS



1228942-T01-A

© 版权为科勒中国有限公司所有，2013
© Copyright Kohler China Ltd., 2013

沿此线切割
CUT ALONG THIS LINE

545mm

375 mm