

**NOTE: BEFORE CUTTING COUNTERTOP ALLOW FOR HANDLE CLEARANCE.**  
注意: 切割台面前, 请预留龙头把手的操作距离。

FINISHED WALL / BACK SPLASH  
完工墙面/防溅挡板

CENTERLINE OF FITTING  
安装中线

**KOHLER**

**K-99183T**  
**乔司 CHALICE**

椭圆形时尚脸盆  
OVAL VESSEL  
切割图/安装说明书

CUT-OUT TEMPLATE / INSTALLATION INSTRUCTIONS

**安装之前**

- 留意当地所有给排水及建筑规定。
- 检查污水管及供水管, 如有需要请更换。
- 安装之前, 先开启新脸盆的包装, 并小心检验新的脸盆是否有损坏, 再将脸盆放回包装盒内, 到安装时才取用。
- 若为更换新脸盆, 须确保现有的柜台孔口与新脸盆的切割位相同或较后者小。
- 请使用同时印在此说明书上的切割图, 标划正确之切割位。
- 科勒洗脸盆是根据美国标准制造的, 与美式洗脸盆配件相配。其它洗脸盆配件可能与之不相配。

**所需工具及物料**  
(不随货供应)

- 模板(已提供)
- 护眼镜
- 铅笔
- 剪刀
- 卷尺
- 涂油灰刀
- 水管用油灰
- 钢锯
- 穿孔线锯或手提电锯
- 钻头(直径为13mm钻头或更大)
- 活扳板钳
- 喉管扳钳
- 切管刀

**BEFORE YOU BEGIN**

- Observe all local plumbing and building codes.
- Inspect the waste and supply tubing, replace if necessary.
- Prior to installation, unpack the new lavatory and carefully inspect it for damage. Return the lavatory to its protective carton until you are ready to install it.
- For replacement installations, make sure the existing cutout is the same or smaller size as the new lavatory.
- Use the template supplied with the lavatory to mark correct size cutout.
- Kohler lavatory is made according to American National Standard that it can match the American lavatory fittings. Any other lavatory fittings may not fit for kohler lavatory.

**TOOLS AND MATERIALS**  
(Not Supplied)

- Template(supplied)
- Safety Glasses
- Pencil
- Scissors
- Tape Measure
- Putty Knife
- Plumbers putty
- Hacksaw
- Keyhole Saw or Saber Saw
- Drill (13mm or 1/2" dia. drill bit or larger)
- Adjustable Wrench
- Pipe wrench
- Tubing Cutter

**尺寸图**

Reference Value  
参考值

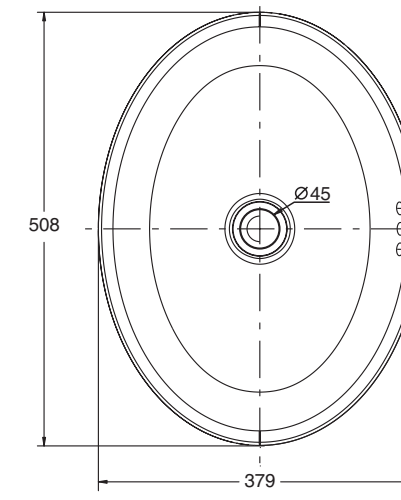

**ROUGHING-IN**

Unit: mm  
单位: 毫米

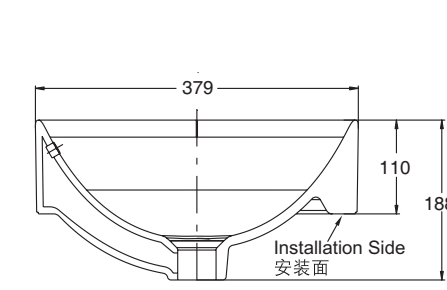

	Length 长	Width 宽	Height 高	Depth 盆深
Outer 外尺寸	508	379	188	
Inner 内尺寸	501	371		140

科勒公司保留随时变更图中标示尺寸的权利, 无需另行通知。  
Kohler reserves the right to change marked dimensions without prior notice.

**安装新脸盆**

- 用剪刀沿切割线将切割图剪出。
- 将切割图放在置洗台上, 定出洗脸盆的安装位置, 确保脸盆、龙头和防溅板之间有足够空间。

注意: 洗脸盆在台面的安装位置应考虑须安装龙头的尺寸。如太靠近墙面, 可能会使排水提拉杆无法安装或不能正常使用。

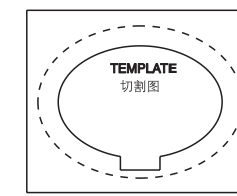

**INSTALL NEW LAVATORY**

- Cut the template on the cutout line with scissors.
- Position the template on the countertop to determine lavatory installation position. Make sure enough space between the lavatory, faucet and backsplash.

Note: Please take faucet dimension into account. If the lavatory installation position is too close to the wall, the drain lift rod might experience difficulty in fixing and using.

- 用铅笔在台面上沿切割线画出切割轮廓。

LEAVE SOME SPACE  
留有一定的空间

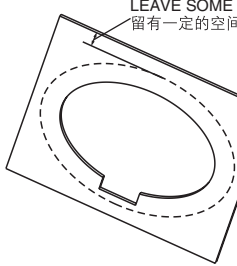

- Trace the template with a pencil (B) to map the outer rim of the lavatory onto the countertop.

- 用一个13mm的钻头, 在切割口内侧钻一个导孔。
- 沿着自切割图勾划出来的铅笔线内侧切开台面。
- 根据安装的龙头和台面尺寸, 正确切割龙头安装孔。

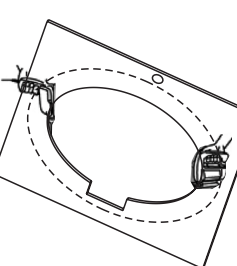

- Drill a 13mm hole on the inside of the cutout opening.
- Cut the opening in the countertop along the inside edge of the pencil line.
- Drill the faucet installation hole according to faucet and countertop dimension.

注意: 龙头安装孔的尺寸一定要准确, 否则可能会使龙头无法正常使用。

Note: The faucet installation hole shall be precisely drilled, otherwise, it may affect faucet performance in the future use.

- 暂将脸盆放入台面开口, 校正位置。
- 小心: 提防身体受伤或损坏产品。因大型脸盆相当重, 需找人帮您一起搬动及安放。

CAUTION: Risk of personal injury or product damage. Large lavatories are very heavy. Get help lifting the lavatory into place.

- 将脸盆移开, 按照制造商的指引, 安装水龙头和排水管道。

- Remove the lavatory. Install the faucet and drain according to the manufacturers instructions.

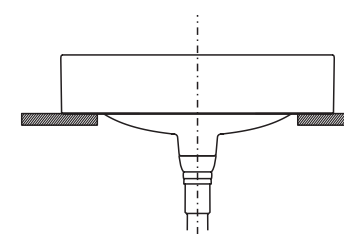

- 在脸盆底部涂抹密封胶。

- Apply sealant to the bottom installation area.

- 小心地将脸盆置于台面切口适当位置, 向下按牢。
- 小心: 提防身体受伤或损坏产品。因大型脸盆相当重, 需找人帮您一起搬动及安放。

CAUTION: Risk of personal injury or product damage. Large lavatories are very heavy. Get help lifting the lavatory into place.

- 立即擦去多余的密封胶, 如脸盆外缘与台面间有缝隙, 即用胶填满。
- 检查脸盆的位置准确。
- 最少待三十分钟, 让密封胶干透后, 方可继续进行安装。
- 联接水龙头供水管。
- 联接排水装置。
- 开启水龙头阀门, 检查有否渗漏。
- 用非腐蚀性清洁剂来清洁。

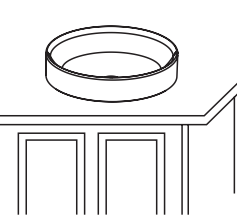

- Immediately wipe away any excess sealant, and fill any voids as needed.
- Verify that the lavatory has not moved out of position.
- Allow the sealant to cure for at least 30 minutes before proceeding.
- Connect the faucet supply lines.
- Connect the drain assembly.
- Open the faucet valves, and check for leakage.
- Clean up with a non-abrasive cleaner.

注1: 请确保切割尺寸与切割图上标识相同。

Note 1: Make sure horizontal and vertical dimensions match dimensions labeled on the template.

注2: 禁止使用环氧树脂胶。

Note 2: It is prohibited to use epoxy resin as the sealant.

注3: 龙头与进水、排水管件连接要牢固, 如连接不牢固, 有漏水的可能。

Note 3: Faucet needs to be tightly connected with inlet and outlet supplies. Otherwise, it may lead to leakage.

**用户须知**  
(护理和清洁)

- 为保持脸盆光洁如新, 须确保每次使用后彻底冲洗干净, 切勿使用腐蚀性的清洁剂, 以免刮花及破坏脸盆的表面。要清除顽固污垢, 油漆或柏油, 可使用松油或油漆稀释剂。
- 不要在0°C以下的水环境中使用。
- 请勿使用钢丝球等硬质材料擦洗产品表面, 特别是产品商标处。

**IMPORTANT CONSUMER INFORMATION (CARE AND CLEANING)**

- To keep your lavatory looking new, make sure you rinse it out thoroughly after each use. DO NOT USE ABRASIVES on this product, as they will scratch and ruin the surface. Stubborn stains, paint, or tar can be removed with turpentine or paint thinner.
- Do not use the product in the water below 0°C.
- Please do not use hard materials (like scouring pad) to clean product surface, especially the product logo.

1220340-T01-A

© 版权为科勒中国有限公司所有, 2013  
© Copyright Kohler China Ltd., 2013