

Operation

Industrial Generator Sets

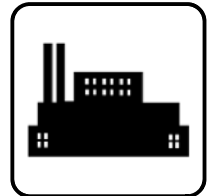

Models:

20-3250 kW

Controllers:

Decision-Maker® 550

Software (Code) Version 3.4.3 or higher

⚠ WARNING: This product can expose you to chemicals, including carbon monoxide and benzene, which are known to the State of California to cause cancer and birth defects or other reproductive harm. For more information go to www.P65warnings.ca.gov

⚠ WARNING: Breathing diesel engine exhaust exposes you to chemicals known to the State of California to cause cancer and birth defects or other reproductive harm.

- Always start and operate the engine in a well-ventilated area.
- If in an enclosed area, vent the exhaust to the outside.
- Do not modify or tamper with the exhaust system.
- Do not idle the engine except as necessary.

For more information go to www.P65warnings.ca.gov/diesel

Product Identification Information

Product identification numbers determine service parts. Record the product identification numbers in the spaces below immediately after unpacking the products so that the numbers are readily available for future reference. Record field-installed kit numbers after installing the kits.

Generator Set Identification Numbers

Record the product identification numbers from the generator set nameplate(s).

Model Designation _____
 Specification Number _____
 Serial Number _____

Accessory Number	Accessory Description
_____	_____
_____	_____
_____	_____
_____	_____
_____	_____

Engine Identification

Record the product identification information from the engine nameplate.

Manufacturer _____
 Model Designation _____
 Serial Number _____

Controller Identification

Record the controller description from the generator set operation manual, spec sheet, or sales invoice. Record the Controller Serial Number from the controller nameplate.

Controller Description Decision-Maker® 550
 Controller Serial Number _____

Firmware/Software Version Numbers

Record the version and reference numbers as shipped from the manufacturer. Determine the Application Program Version Number as shown in Menu 20. Determine the Personality Profile Reference Number from the disk supplied with the literature packet.

Application Program Version Number _____
 Personality Profile Reference Number _____
 User Parameter File Reference Number _____

Version Number Upgrades/Updates

Record the version number upgrade/updates when installed.

Version No./Date Installed _____

Software Options

Record the software options.
 Number and Description _____

Table of Contents

Safety Precautions and Instructions	7
Introduction	13
Abbreviations	13
List of Related Materials	13
Service Assistance	14
Section 1 Specifications and Features	15
1.1 Introduction	15
1.2 Controller Features	15
1.2.1 Annunciator Lamps	16
1.2.2 Digital Display and Keypad	18
1.2.3 Switches and Controls	20
1.2.4 Controller Circuit Boards	21
1.2.5 Fuses	21
1.2.6 Terminal Strips and Connectors	21
1.2.7 Circuit Board Interconnections for Calibration Procedure	22
1.2.8 Communication Ports	23
1.3 Controller Logic Specifications	23
1.3.1 Status Event and Fault Specifications	23
1.3.2 Voltage Regulator and Calibration Specifications	33
1.3.3 Voltage Regulator Adjustments	33
Section 2 Operation	35
2.1 Prestart Checklist	35
2.2 Exercising Generator Set	35
2.3 Operation in Cold Weather Climates	36
2.4 Controller Operation	36
2.4.1 Starting	36
2.4.2 Stopping (User Stopping and Fault Shutdown)	37
2.4.3 Emergency Stop Switch Resetting	38
2.4.4 Status Lamps	38
2.4.5 System Warning Lamp	39
2.4.6 System Shutdown Lamp	42
2.4.7 Controller Resetting (Following System Shutdown or Warning)	45
2.5 Menu List Summary	45
2.6 Reviewing Digital Display	51
2.6.1 Keypad Operation	51
2.6.2 Auto-Scroll Function	52
2.6.3 Request and Error Messages	52
2.7 Monitoring and Programming Setup	53
2.7.1 PC Communications	54
2.7.2 Modbus Communications	56
2.8 Reviewing Menu Displays	57
2.8.1 Menu 1—Generator Monitoring	58
2.8.2 Menu 2—Engine Monitoring	60
2.8.3 Menu 3—Analog Monitoring	62
2.8.4 Menu 4—Operational Records	63
2.8.5 Menu 5—Event History	64
2.8.6 Menu 6—Time and Date	64
2.8.7 Menu 7—Generator System	64
2.8.8 Menu 8—Time Delays	66
2.8.9 Menu 9—Input Setup	67
2.8.10 Menu 10—Output Setup	69
2.8.11 Menu 11—Voltage Regulator	71
2.8.12 Menu 12—Calibration	72
2.8.13 Menu 13—Communications	73

Table of Contents, continued

2.8.14	Menu 14—Programming Mode	74
2.8.15	Menu 15—Protective Relays (PR)	75
2.8.16	Menu 18—Battery Chargers (Version 3.4.3 or Higher)	76
2.8.17	Menu 20—Factory Setup (Version 2.10)	78
2.8.18	Menu 20—Factory Setup (Version 2.21)	79
2.8.19	Menu 20—Factory Setup (Version 3.01)	80
2.9	Local Programming Mode On	81
2.9.1	Menu 1—Generator Monitoring	82
2.9.2	Menu 2—Engine Monitoring	86
2.9.3	Menu 3—Analog Monitoring	90
2.9.4	Menu 4—Operational Records	93
2.9.5	Menu 5—Event History	95
2.9.6	Menu 6—Time and Date	96
2.9.7	Menu 7—Generator System	97
2.9.8	Menu 8—Time Delays	105
2.9.9	Menu 9—Input Setup	107
2.9.10	Menu 10—Output Setup	113
2.9.11	Menu 11—Voltage Regulator	123
2.9.12	Menu 12—Calibration	129
2.9.13	Menu 13—Communications	135
2.9.14	Menu 14—Programming Mode	141
2.9.15	Menu 15—Protective Relays (PR)	143
2.9.16	Menu 18—Battery Chargers	147
2.9.17	Menu 20—Factory Setup	152
Section 3 Scheduled Maintenance		155
3.1	Alternator Service	155
3.2	Engine Service	155
3.3	Service Schedule	156
3.4	Alternator Bearing Service	158
3.4.1	20–300 kW Models	158
3.4.2	300–2250 kW Models with Single-Bearing Alternator	158
3.4.3	1250 kW and Larger Models with Two-Bearing Alternator	158
3.5	Diesel Fuel Systems	158
3.5.1	Bleeding Air from Fuel System	158
3.5.2	Subbase Fuel Day Tank Electronic Control Module (ECM)	159
3.5.3	Subbase Inner Fuel Tank Alarm	160
3.6	Gaseous Fuel Systems	161
3.6.1	Gaseous Fuel System Concept (Single Fuel)	161
3.6.2	LPG Liquid Withdrawal Fuel System Concept	161
3.6.3	Natural Gas and LPG Conversion	161
3.6.4	Fuel System Changeover Kits (Dual Fuel)	163
3.6.5	Crankcase Ventilation (CCV) Heater Kit GM78171-KP1	163
3.7	Air Cleaner Restriction Indicator (if equipped)	164
3.8	Cooling System	164
3.8.1	Coolant Level Check	164
3.8.2	Cooling System Component Inspection	164
3.8.3	Procedure to Drain Cooling System	165
3.8.4	Procedure to Flush and Clean Cooling System	165
3.8.5	Procedure to Refill Cooling System	165
3.9	Radiator Fan Bolt Retorque	165
3.10	Radiator Expansion Joint Loosening—Initial Setup Only	166
3.11	Radiator Fan Bearing Lubrication	167
3.12	Battery	168
3.12.1	Clean Battery	168

Table of Contents, continued

3.12.2	Electrolyte Level Inspection	169
3.12.3	Specific Gravity Check	170
3.12.4	Charge Battery	170
3.13	Detroit Diesel Engine Control Systems	171
3.13.1	Features	171
3.13.2	DDEC Engine Diagnostics	171
3.14	Engine Control Systems	172
3.15	Storage Procedure	172
3.15.1	Lubricating System	173
3.15.2	Cooling System	173
3.15.3	Fuel System	173
3.15.4	Internal Engine Components (Gaseous-Fueled Engines)	173
3.15.5	Exterior	174
3.15.6	Battery	174
Section 4 General Troubleshooting		175
4.1	General Troubleshooting Chart	176
4.2	Controller Display and Voltage Regulation Troubleshooting Chart	179
Section 5 Generator Set Reconnection		181
5.1	Introduction	181
5.2	Voltage Reconnection Procedure	182
Section 6 Accessories		187
6.1	Accessories and Connections	187
6.1.1	Audiovisual Alarm Kit	187
6.1.2	Common Failure Relay Kit	188
6.1.3	Battery Charger Kit with Alarm Option	188
6.1.4	Controller (Customer) Connection Kit	189
6.1.5	Ground Fault Annunciation	190
6.1.6	Idle (Speed) Mode Feature	191
6.1.7	Low Fuel (Level/Pressure) Switch	192
6.1.8	Prime Power Switch Kit	192
6.1.9	Remote Emergency Stop Kit	193
6.1.10	Remote Reset Feature	193
6.1.11	Remote Serial Annunciator (RSA)	194
6.1.12	Remote Speed Adjust Kit (ECM Models)	196
6.1.13	Remote Speed Adjustment Potentiometer Kit (Non-ECM Models)	196
6.1.14	Run Relay Kit	197
6.1.15	Shunt-Trip Line Circuit Breaker	197
6.1.16	Single-Relay Dry Contact Kit	198
6.1.17	Ten-Relay Dry Contact Kit	198
6.1.18	Twenty-Relay Dry Contact Kit	200
6.2	Accessory Connections	201
Appendix A Abbreviations		207
Appendix B User-Defined Settings		209
Appendix C Voltage Regulator Definitions and Adjustments		219
Appendix D Alternator Protection		225
Appendix E Inputs and System Events by Application		227
Appendix F Controller Displays from the Engine ECM		231
Appendix G DEC 550 Controller Fault Displays		233

Notes

Safety Precautions and Instructions

IMPORTANT SAFETY INSTRUCTIONS. Electromechanical equipment, including generator sets, transfer switches, switchgear, and accessories, can cause bodily harm and pose life-threatening danger when improperly installed, operated, or maintained. To prevent accidents be aware of potential dangers and act safely. Read and follow all safety precautions and instructions. **SAVE THESE INSTRUCTIONS.**

This manual has several types of safety precautions and instructions: Danger, Warning, Caution, and Notice.

DANGER

Danger indicates the presence of a hazard that **will cause severe personal injury, death, or substantial property damage.**

WARNING

Warning indicates the presence of a hazard that **can cause severe personal injury, death, or substantial property damage.**

CAUTION

Caution indicates the presence of a hazard that **will or can cause minor personal injury or property damage.**

NOTICE

Notice communicates installation, operation, or maintenance information that is safety related but not hazard related.



Safety decals affixed to the equipment in prominent places alert the operator or service technician to potential hazards and explain how to act safely. The decals are shown throughout this publication to improve operator recognition. Replace missing or damaged decals.

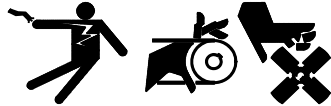

Accidental Starting

 WARNING

Accidental starting. Can cause severe injury or death.
Disconnect the battery cables before working on the generator set. Remove the negative (-) lead first when disconnecting the battery. Reconnect the negative (-) lead last when reconnecting the battery.

Disabling the generator set. Accidental starting can cause severe injury or death. Before working on the generator set or equipment connected to the set, disable the generator set as follows: (1) Move the generator set master switch to the OFF position. (2) Disconnect the power to the battery charger. (3) Remove the battery cables, negative (-) lead first. Reconnect the negative (-) lead last when reconnecting the battery. Follow these precautions to prevent starting of the generator set by an automatic transfer switch, remote start/stop switch, or engine start command from a remote computer.

Battery

 WARNING

Sulfuric acid in batteries. Can cause severe injury or death.
Wear protective goggles and clothing. Battery acid may cause blindness and burn skin.

 WARNING

Explosion. Can cause severe injury or death. Relays in the battery charger cause arcs or sparks.
Locate the battery in a well-ventilated area. Isolate the battery charger from explosive fumes.

Battery electrolyte is a diluted sulfuric acid. Battery acid can cause severe injury or death. Battery acid can cause blindness and burn skin. Always wear splashproof safety goggles, rubber gloves, and boots when servicing the battery. Do not open a sealed battery or mutilate the battery case. If battery acid splashes in the eyes or on the skin, immediately flush the affected area for 15 minutes with large quantities of clean water. Seek immediate medical aid in the case of eye contact. Never add acid to a battery after placing the battery in service, as this may result in hazardous spattering of battery acid.



Battery acid cleanup. Battery acid can cause severe injury or death. Battery acid is electrically conductive and corrosive. Add 500 g (1 lb.) of bicarbonate of soda (baking soda) to a container with 4 L (1 gal.) of water and mix the neutralizing solution. Pour the neutralizing solution on the spilled battery acid and continue to add the neutralizing solution to the spilled battery acid until all evidence of a chemical reaction (foaming) has ceased. Flush the resulting liquid with water and dry the area.

Battery gases. Explosion can cause severe injury or death. Battery gases can cause an explosion. Do not smoke or permit flames or sparks to occur near a battery at any time, particularly when it is charging. Do not dispose of a battery in a fire. To prevent burns and sparks that could cause an explosion, avoid touching the battery terminals with tools or other metal objects. Remove all jewelry before servicing the equipment. Discharge static electricity from your body before touching batteries by first touching a grounded metal surface away from the battery. To avoid sparks, do not disturb the battery charger connections while the battery is charging. Always turn the battery charger off before disconnecting the battery connections. Ventilate the compartments containing batteries to prevent accumulation of explosive gases.

Battery short circuits. Explosion can cause severe injury or death. Short circuits can cause bodily injury and/or equipment damage. Disconnect the battery before generator set installation or maintenance. Remove all jewelry before servicing the equipment. Use tools with insulated handles. Remove the negative (-) lead first when disconnecting the battery. Reconnect the negative (-) lead last when reconnecting the battery. Never connect the negative (-) battery cable to the positive (+) connection terminal of the starter solenoid. Do not test the battery condition by shorting the terminals together.

Battery gases. Explosion can cause severe injury or death. Incorrect use of the equalize charge state may lead to hazardous situations. Equalization is ONLY applicable for flooded lead acid (FLA) type batteries and will damage gel, absorbed glass mat (AGM), or nickel-cadmium (NiCad) type batteries. In the controller menu or SiteTech™ settings, verify that the battery topology is set correctly for the battery type used. Do not smoke or permit flames, sparks, or other sources of ignition to occur near a battery at any time.

Engine Backfire/Flash Fire



 WARNING

<p>Risk of fire. Can cause severe injury or death.</p> <p>Do not smoke or permit flames or sparks near fuels or the fuel system.</p>

Servicing the fuel system. A flash fire can cause severe injury or death. Do not smoke or permit flames or sparks near the carburetor, fuel line, fuel filter, fuel pump, or other potential sources of spilled fuels or fuel vapors. Catch fuels in an approved container when removing the fuel line or carburetor.

Servicing the air cleaner. A sudden backfire can cause severe injury or death. Do not operate the generator set with the air cleaner removed.

Combustible materials. A fire can cause severe injury or death. Generator set engine fuels and fuel vapors are flammable and explosive. Handle these materials carefully to minimize the risk of fire or explosion. Equip the compartment or nearby area with a fully charged fire extinguisher. Select a fire extinguisher rated ABC or BC for electrical fires or as recommended by the local fire code or an authorized agency. Train all personnel on fire extinguisher operation and fire prevention procedures.

Exhaust System

 WARNING

<p>Carbon monoxide. Can cause severe nausea, fainting, or death.</p> <p>The exhaust system must be leakproof and routinely inspected.</p>



Generator set operation. Carbon monoxide can cause severe nausea, fainting, or death. Carbon monoxide is an odorless, colorless, tasteless, nonirritating gas that can cause death if inhaled for even a short time. Avoid breathing exhaust fumes when working on or near the generator set. Never operate the generator set inside a building unless the exhaust gas is piped safely outside. Never operate the generator set where exhaust gas could accumulate and seep back inside a potentially occupied building.

Carbon monoxide symptoms. Carbon monoxide can cause severe nausea, fainting, or death. Carbon monoxide is a poisonous gas present in exhaust gases. Carbon monoxide is an odorless, colorless, tasteless, nonirritating gas that can cause death if inhaled for even a short time. Carbon monoxide poisoning symptoms include but are not limited to the following:

- Light-headedness, dizziness
- Physical fatigue, weakness in joints and muscles
- Sleepiness, mental fatigue, inability to concentrate or speak clearly, blurred vision
- Stomachache, vomiting, nausea

If experiencing any of these symptoms and carbon monoxide poisoning is possible, seek fresh air immediately and remain active. Do not sit, lie down, or fall asleep. Alert others to the possibility of carbon monoxide poisoning. Seek medical attention if the condition of affected persons does not improve within minutes of breathing fresh air.

Fuel System

 WARNING

<p>Explosive fuel vapors. Can cause severe injury or death.</p> <p>Use extreme care when handling, storing, and using fuels.</p>

The fuel system. Explosive fuel vapors can cause severe injury or death. Vaporized fuels are highly explosive. Use extreme care when handling and storing fuels. Store fuels in a well-ventilated area away from spark-producing equipment and out of the reach of children. Never add fuel to the tank while the engine is running because spilled fuel may ignite on contact with hot parts or from sparks. Do not smoke or permit flames or sparks to occur near sources of spilled fuel or fuel vapors. Keep the fuel lines and connections tight and in good condition. Do not replace flexible fuel lines with rigid lines. Use flexible sections to avoid fuel line breakage caused by vibration. Do not operate the generator set in the presence of fuel leaks, fuel accumulation, or sparks. Repair fuel systems before resuming generator set operation.

Explosive fuel vapors can cause severe injury or death. Take additional precautions when using the following fuels:

Gasoline—Store gasoline only in approved red containers clearly marked GASOLINE.

Propane (LPG)—Adequate ventilation is mandatory. Because propane is heavier than air, install propane gas detectors low in a room. Inspect the detectors per the manufacturer's instructions.

Natural Gas—Adequate ventilation is mandatory. Because natural gas rises, install natural gas detectors high in a room. Inspect the detectors per the manufacturer's instructions.



Fuel tanks. Explosive fuel vapors can cause severe injury or death. Gasoline and other volatile fuels stored in day tanks or subbase fuel tanks can cause an explosion. Store only diesel fuel in tanks.

Draining the fuel system. Explosive fuel vapors can cause severe injury or death. Spilled fuel can cause an explosion. Use a container to catch fuel when draining the fuel system. Wipe up spilled fuel after draining the system.

Gas fuel leaks. Explosive fuel vapors can cause severe injury or death. Fuel leakage can cause an explosion. Check the LPG vapor or natural gas fuel system for leakage by using a soap and water solution with the fuel system test pressurized to 6–8 ounces per square inch (10–14 inches water column). Do not use a soap solution containing either ammonia or chlorine because both prevent bubble formation. A successful test depends on the ability of the solution to bubble.

LPG liquid withdrawal fuel leaks. Explosive fuel vapors can cause severe injury or death. Fuel leakage can cause an explosion. Check the LPG liquid withdrawal fuel system for leakage by using a soap and water solution with the fuel system test pressurized to at least 90 psi (621 kPa). Do not use a soap solution containing either ammonia or chlorine because both prevent bubble formation. A successful test depends on the ability of the solution to bubble.

Hazardous Noise

 CAUTION

<p>Hazardous noise. Can cause hearing loss.</p> <p>Never operate the generator set without a muffler or with a faulty exhaust system.</p>

Engine noise. Hazardous noise can cause hearing loss. Generator sets not equipped with sound enclosures can produce noise levels greater than 105 dBA. Prolonged exposure to noise levels greater than 85 dBA can cause permanent hearing loss. Wear hearing protection when near an operating generator set.

Hazardous Voltage/ Moving Parts

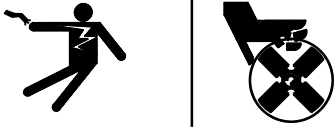
⚠ DANGER

<p>Hazardous voltage. Will cause severe injury or death.</p> <p>Disconnect all power sources before opening the enclosure.</p>

⚠ DANGER

<p>Hazardous voltage. Moving parts. Will cause severe injury or death.</p> <p>Operate the generator set only when all guards and electrical enclosures are in place.</p>

⚠ WARNING

<p>Hazardous voltage. Backfeed to the utility system can cause property damage, severe injury, or death.</p> <p>If the generator set is used for standby power, install an automatic transfer switch to prevent inadvertent interconnection of standby and normal sources of supply.</p>

Grounding electrical equipment. Hazardous voltage will cause severe injury or death. Electrocutation is possible whenever electricity is present. Ensure you comply with all applicable codes and standards. Electrically ground the generator set, transfer switch, and related equipment and electrical circuits. Turn off the main circuit breakers of all power sources before servicing the equipment. Never contact electrical leads or appliances when standing in water or on wet ground because these conditions increase the risk of electrocution.

High voltage test. Hazardous voltage will cause severe injury or death. Follow the instructions of the test equipment manufacturer when performing high-voltage tests on the rotor or stator. An improper test procedure can damage equipment or lead to generator set failure.

Installing the battery charger. Hazardous voltage will cause severe injury or death. An ungrounded battery charger may cause electrical shock. Connect the battery charger enclosure to the ground of a permanent wiring system. As an alternative, install an equipment grounding conductor with circuit conductors and connect it to the equipment grounding terminal or the lead on the battery charger. Install the battery charger as prescribed in the equipment manual. Install the battery charger in compliance with local codes and ordinances.

Connecting the battery and the battery charger. Hazardous voltage will cause severe injury or death. Reconnect the battery correctly, positive to positive and negative to negative, to avoid electrical shock and damage to the battery charger and battery(ies). Have a qualified electrician install the battery(ies).

Short circuits. Hazardous voltage/current will cause severe injury or death. Short circuits can cause bodily injury and/or equipment damage. Do not contact electrical connections with tools or jewelry while making adjustments or repairs. Remove all jewelry before servicing the equipment.

Engine block heater. Hazardous voltage will cause severe injury or death. The engine block heater can cause electrical shock. Remove the engine block heater plug from the electrical outlet before working on the block heater electrical connections.

Electrical backfeed to the utility. Hazardous backfeed voltage can cause severe injury or death. Install a transfer switch in standby power installations to prevent the connection of standby and other sources of power. Electrical backfeed into a utility electrical system can cause severe injury or death to utility personnel working on power lines.

Testing live electrical circuits. Hazardous voltage or current will cause severe injury or death. Have trained and qualified personnel take diagnostic measurements of live circuits. Use adequately rated test equipment with electrically insulated probes and follow the instructions of the test equipment manufacturer when performing voltage tests. Observe the following precautions when performing voltage tests: (1) Remove all jewelry. (2) Stand on a dry, approved electrically insulated mat. (3) Do not touch the enclosure or components inside the enclosure. (4) Be prepared for the system to operate automatically. (600 volts and under)

Servicing the generator set when it is operating. Exposed moving parts will cause severe injury or death. Keep hands, feet, hair, clothing, and test leads away from the belts and pulleys when the generator set is running. Replace guards, screens, and covers before operating the generator set.

Heavy Equipment

⚠ WARNING

Unbalanced weight. Improper lifting can cause severe injury or death and equipment damage.
Do not use lifting eyes. Lift the generator set using lifting bars inserted through the lifting holes on the skid.

Hot Parts

⚠ WARNING

Hot coolant and steam. Can cause severe injury or death.
Before removing the pressure cap, stop the generator set and allow it to cool. Then loosen the pressure cap to relieve pressure.

⚠ WARNING

Hot engine and exhaust system. Can cause severe injury or death.
Do not work on the generator set until it cools.

Servicing the alternator. Hot parts can cause severe injury or death. Avoid touching the alternator field or exciter armature. When shorted, the alternator field and exciter armature become hot enough to cause severe burns.

Servicing the exhaust system. Hot parts can cause severe injury or death. Do not touch hot engine parts. The engine and exhaust system components become extremely hot during operation.

Notice

NOTICE
This generator set has been rewired from its nameplate voltage to

246242

NOTICE
Voltage reconnection. Affix a notice to the generator set after reconnecting the set to a voltage different from the voltage on the nameplate. Order voltage reconnection decal 246242 from an authorized service distributor/dealer.

NOTICE
Canadian installations only. For standby service connect the output of the generator set to a suitably rated transfer switch in accordance with Canadian Electrical Code, Part 1.

Notes

This manual provides operation instructions for 20 kW and larger generator sets equipped with the following controller:

- Decision® 550, Software (Code) Version 2.10 or higher

Version 2.10 refers to the controller application software. To determine the generator set controller software version, go to Menu 20—Factory Setup and scroll down to *Code Version*. The code version is the controller software version.

Wiring diagram manuals are available separately. Refer to the engine operation manual for generator set engine scheduled maintenance information.

Information in this publication represents data available at the time of print. Kohler Co. reserves the right to change this publication and the products represented without notice and without any obligation or liability whatsoever.

Read this manual and carefully follow all procedures and safety precautions to ensure proper equipment operation and to avoid bodily injury. Read and follow the Safety Precautions and Instructions section at the beginning of this manual. Keep this manual with the equipment for future reference.

The equipment service requirements are very important to safe and efficient operation. Inspect the parts often and perform required service at the prescribed intervals. Maintenance work must be performed by appropriately skilled and suitably trained maintenance personnel familiar with generator set operation and service.

The disk supplied with this generator set is a backup copy of the generator set personality program containing data specific to the engine and alternator. The engine and alternator data was preprogrammed in the controller at the factory and no further use of the disk should be necessary. Typically, your authorized distributor stores this disk for possible future use such as controller replacement or other circumstances requiring a backup.

Abbreviations

This publication makes use of numerous abbreviations. Typically, the word(s) are spelled out along with the abbreviation in parentheses when shown for the first time in a section. Appendix A, Abbreviations, also includes many abbreviation definitions.

List of Related Materials

Separate literature contains communication and software information not provided in this manual. Figure 1 lists the available literature part numbers.

Communication and Software Manual Description	Literature Part No.
550 Controller Spec Sheet	G6-46
Generator Set/Controller Wiring Diagram Manual	Multiple Part Numbers Contact your Distributor/Dealer
550 Communications Spec Sheet	G6-50
Monitor III Converters, Connections, and Controller Setup	TT-1405
Monitor III Software Spec Sheet	G6-76
Monitor III Converter, Modbus®/Ethernet Spec Sheet	G6-79
Monitor III Software Operation Manual	TP-6347
Modbus® Communications Protocol Operation Manual	TP-6113
Setup and Application Manual	TP-6140
Service Parts Controllers	TP-6780
Program Loader Software Installation	TT-1285
SiteTech™ Software Operation Manual	TP-6701
Remote Serial Annunciator (RSA)	TT-1377
Remote Serial Annunciator (RSA II)	TT-1485
Controller Service Replacement	TT-1310

Figure 1 Related Literature

Service Assistance

For professional advice on generator set power requirements and conscientious service, please contact your nearest Kohler distributor or dealer.

- Visit the Kohler Co. website at KOHLERPower.com.
- Look at the labels and decals on your Kohler product or review the appropriate literature or documents included with the product.
- Call toll free in the US and Canada 1-800-544-2444.
- Outside the US and Canada, call the nearest regional office.

Headquarters Europe, Middle East, Africa (EMEA)

Kohler EMEA Headquarters
Netherlands B.V.
Kristallaan 1
4761 ZC Zevenbergen
The Netherlands
Phone: (31) 168 331630
Fax: (31) 168 331631

Asia Pacific

Kohler Asia Pacific Headquarters
Singapore, Republic of Singapore
Phone: (65) 6264-6422
Fax: (65) 6264-6455

China

North China Regional Office, Beijing
Phone: (86) 10 6518 7950
(86) 10 6518 7951
(86) 10 6518 7952
Fax: (86) 10 6518 7955

East China Regional Office, Shanghai
Phone: (86) 21 6288 0500
Fax: (86) 21 6288 0550

India, Bangladesh, Sri Lanka

India Regional Office
Bangalore, India
Phone: (91) 80 3366208
(91) 80 3366231
Fax: (91) 80 3315972

Japan, Korea

North Asia Regional Office
Tokyo, Japan
Phone: (813) 3440-4515
Fax: (813) 3440-2727

Section 1 Specifications and Features

1.1 Introduction

The spec sheets for each generator set provide model-specific generator and engine information. The controller spec sheet provides specifications for this controller. Refer to the respective spec sheet for data not supplied in this manual. Consult the generator set service manual, installation manual, engine operation manual, and engine service manual for additional specifications.

The controller features, accessories, and menu displays depend upon the engine electronic control module (ECM) setup and features. Controller features apply to generator set models with ECM and non-ECM engines unless otherwise noted.

Note: Press any key on the keypad to turn on the controller lights and display. The lights and display turn off 5 minutes after the last keypad entry.

1.2 Controller Features

The controller features include the annunciator lamps, digital display and keypad, switches and controls, and fuses and terminal strip. The following paragraphs detail the features by general topics.

Note: Measurements display in metric or English. Use Menu 7—Generator System to change the measurement display.

See Figure 1-1 for an illustration of the controller front panel. See Figure 1-2 for an illustration of the controller with the keyswitch option.

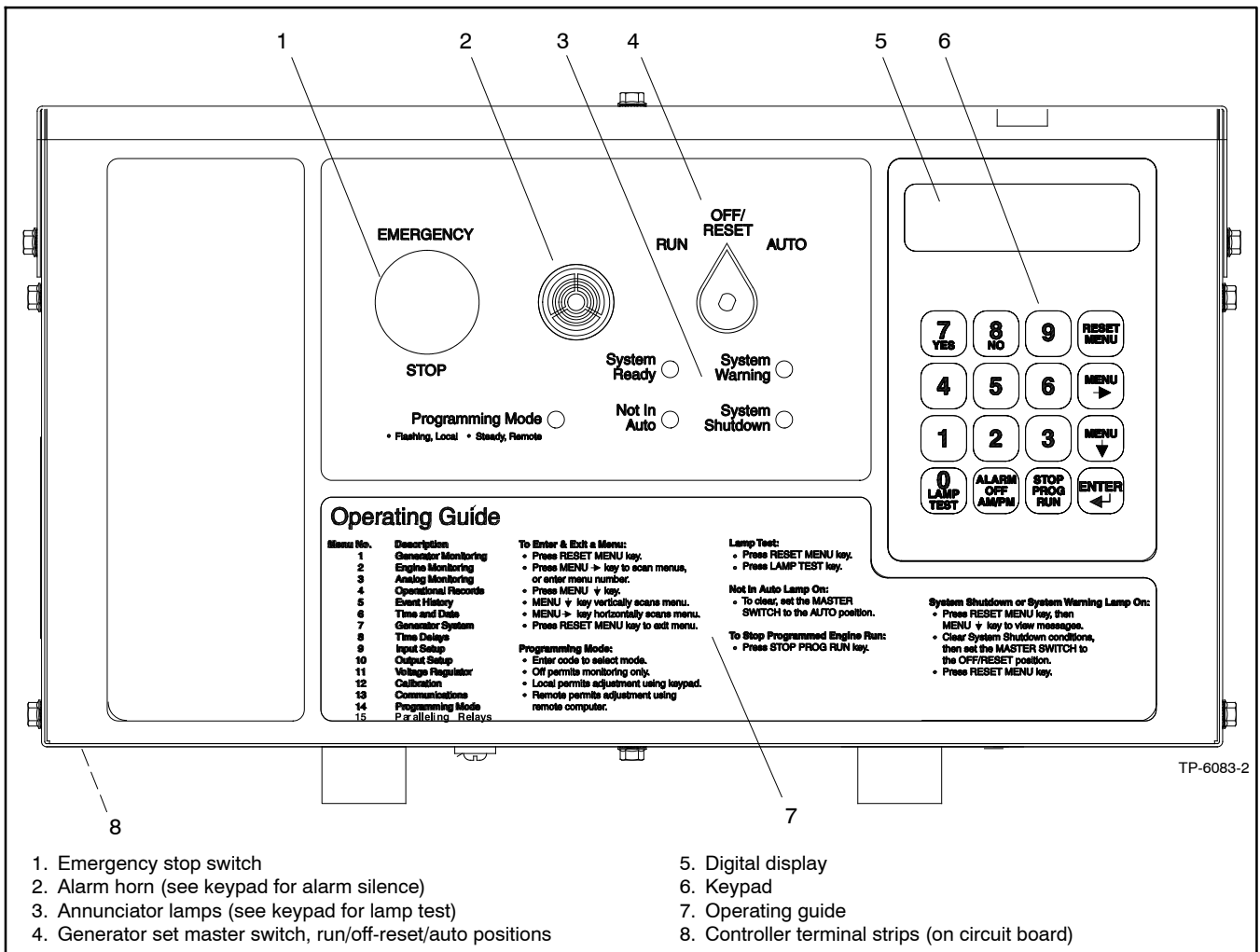

Figure 1-1 550 Controller with Three-Position Selector Switch

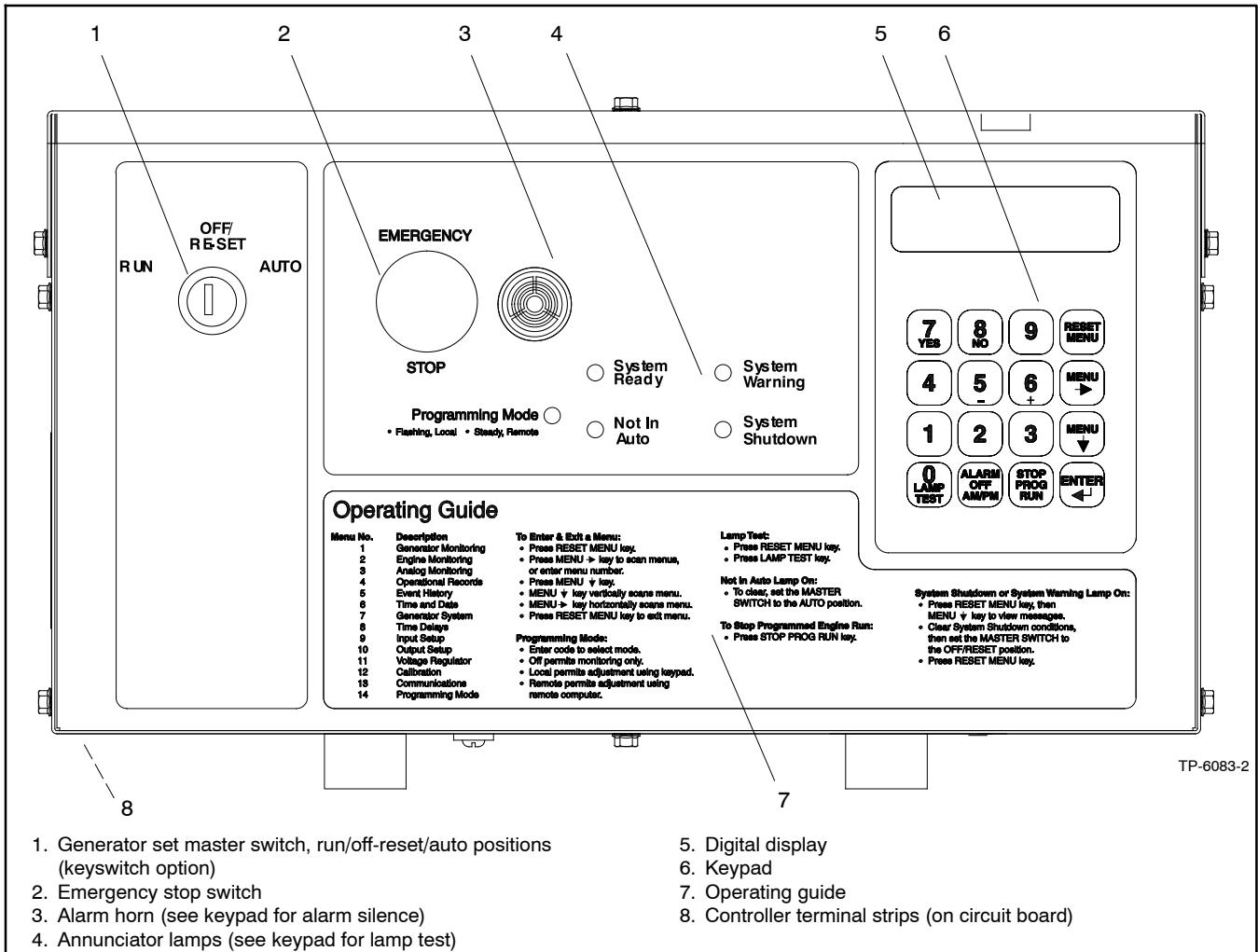

Figure 1-2 550 Controller with Keyswitch Option

1.2.1 Annunciator Lamps

Five annunciator lamps provide visual generator set status. See Figure 1-3.

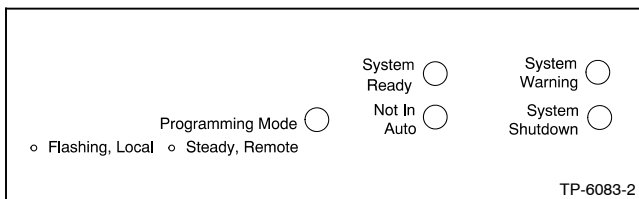

Figure 1-3 Annunciator Lamps

System Ready. Green lamp illuminates when the generator set master switch is in the AUTO (automatic start) position and the system senses no faults. The unit is ready to start.

Not in Auto (NIA). Yellow lamp illuminates when the generator set master switch is not in the AUTO (automatic start) position.

Programming Mode. Yellow programming lamp indicates the user selected programming mode. See Figure 1-4.

Programming Lamp	Programming Mode Selection
Lamp Flashing	Local Programming
Lamp Steady On	Remote Programming
Lamp Off	Programming Disabled

Figure 1-4 Programming Lamp Mode

Note: Find additional information for the programming mode lamp function and access to the local or remote programming modes in Section 2.9, Local Programming Mode On, Menu 14—Programming Mode.

System Warning. Yellow lamp identifies an existing fault condition that does not shut down the generator set. A continuing system warning fault condition may cause a system shutdown. Correct all system warnings as soon as practical.

See Section 2.4.5, System Warning Lamp, for definitions of the items listed.

The following conditions cause a system warning:

- Engine functions:
 - ECM yellow alarm (DDC/MTU engine with MDEC/ADEC)
 - High battery voltage
 - High coolant temperature
 - Low battery voltage
 - Low coolant temperature
 - Low fuel (level or pressure)*
 - Low oil pressure
 - Speed sensor fault
 - Starting aid (system status)
 - Weak battery
- General functions:
 - Auxiliary—Analog up to 7 user-selectable inputs each with a high and low programmable warning level
 - Auxiliary—Digital up to 21 user-selectable warnings
 - Battery charger communication error
 - Battery charger fault*
 - Note:** Optional input sensors not required with charger GM87448.
 - Battery charger value mismatch error
 - Emergency power system (EPS) supplying load
 - Engine cooldown delay
 - Engine start delay
 - Load shed kW overload
 - Load shed underfrequency
 - Master switch not in AUTO (automatic start) position
 - NFPA 110 fault (National Fire Protection Association)
 - System ready (system status)
- Alternator functions:
 - AC sensing loss
 - Ground fault*
 - Overcurrent

* Requires optional input sensors

Note: See Figure 2-8 in User Inputs for factory-reserved analog and digital inputs that are not user-selectable.

System Shutdown. Red lamp indicates that the generator set has shut down because of a fault condition. The unit will not start without resetting the controller, see Section 2.4.7, Controller Reset Procedure.

See Section 2.4.6, System Shutdown Lamp, for definitions of the items listed.

The following conditions cause a system shutdown:

- Engine functions:
 - Air damper closed (status), if equipped
 - Coolant temperature signal loss
 - ECM red alarm (DDC/MTU engine with MDEC/ADEC)
 - Engine stalled (ECM only)
 - High coolant temperature
 - High oil temperature
 - Low coolant level
 - Low oil pressure
 - Oil pressure signal loss
 - Overcrank
 - Overspeed
- General functions:
 - Auxiliary—Analog up to 7 user-selectable inputs each with a high and low programmable shutdown level
 - Auxiliary—Digital up to 21 user-selectable shutdowns
 - ECM communications loss (ECM models only)
 - Emergency stop
 - Internal fault
 - Master switch in OFF/RESET position
 - Master switch error
 - Master switch open
 - NFPA 110 fault
- Alternator functions:
 - AC output overvoltage
 - AC output undervoltage
 - Alternator protection against overload and short circuits
 - Field overvoltage (M4, M5, M7, or M10 alternator only)
 - Locked rotor (failed to crank)
 - Overfrequency
 - Underfrequency

Note: See Figure 2-8 in User Inputs for factory-reserved analog and digital inputs which are not user-selectable.

1.2.2 Digital Display and Keypad

Figure 1-5 illustrates the digital display and keypad.

Note: Press any key on the keypad to turn on the controller lights and display. The lights and display turn off 5 minutes after the last keypad entry.

The 2-line vacuum fluorescent display provides generator set and engine condition information.

The 16-button keypad gives the user information access and local programming capability.

Keypad Functions

Alarm (Horn) Off key silences the alarm horn at the operator's discretion. Place the generator set master switch in the AUTO position before silencing the alarm horn. See Section 2.4.7, Controller Reset Procedure, and Section 1.2.3, Switches and Controls.

AM/PM key provides time of day data entries when programming.

Enter ↵ **key** provides confirmation entry when selecting menu or programming.

Lamp Test key tests the controller indicator lamps, horn, and digital display. See Section 1.2.3, Switches and Controls.

Menu down ↓ **key** provides navigation within menus when necessary.

Menu right → **key** provides navigation within menus when necessary.

Numeric 0-9 keys provide numeric data entries when selecting menus or programming.

Reset Menu key exits a menu, clears incorrect entries, and cancels the auto-scroll feature.

Stop Prog (Program) Run key allows the user to stop any previously programmed generator set run sequence. See Section 1.2.3, Switches and Controls.

Yes/No keys provides data answer entries when programming.

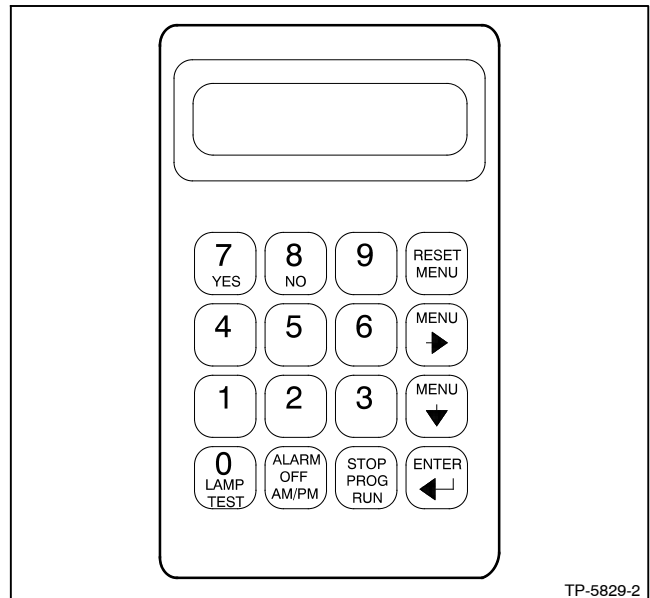

Figure 1-5 Digital Display and Keypad

Alternator Output Displays (Menu 1)

AC Amps displays the alternator output current. The display shows each line of 3-phase models.

AC Volts displays the alternator output voltages. The display shows all line-to-neutral and line-to-line voltage combinations.

Alternator Duty Level displays the actual load kW divided by the nameplate kW rating as a percentage.

Frequency displays the frequency (Hz) of alternator output voltage.

Hourmeter displays the generator set operating hours loaded and unloaded for reference in scheduling maintenance.

KVA displays the total and individual L1, L2, and L3 kVA.

KVAR displays the total and individual L1, L2, and L3 kVAR.

Power Factor displays the kW/kVA and the individual line power factor values.

Watts displays the total and individual L1, L2, and L3 kilowatts.

Engine Displays (Menu 2)

Some engine displays are available with selected generator set engines using engine ECMs only. The controller display shows N/A (not available) for items that are unavailable. See the controller spec sheet for applicable generator set models.

Ambient Temperature displays the generator set area ambient temperature.

Charge Air Pressure displays the engine turbocharger boost air pressure.

Charge Air Temperature displays the engine turbocharger boost air temperature.

Coolant Level displays the engine coolant level.

Coolant Pressure displays the engine coolant pressure.

Coolant Temperature displays the engine coolant temperature.

Crankcase Pressure displays the engine crankcase pressure.

DC Volts displays the voltage of starting battery(ies).

Fuel Pressure displays the fuel supply pressure.

Fuel Rate displays the calculated fuel consumption rate based on fuel injector outputs.

Fuel Temperature displays the fuel supply temperature.

Oil Level displays the engine oil level as a percent of full capacity.

Oil Pressure displays the engine oil pressure.

Oil Temperature displays the engine oil temperature.

RPM (Tachometer) displays the engine speed.

Used Last Run displays the accumulated amount of fuel used since last reset by the engine DDEC reader.

Operational Record Displays (Menus 4 and 5)

The operational record displays events since last reset. See Section 2.9.4, Menu 4—Operational Records, for resetting procedure.

Engine Start Countdown displays the time remaining before the next generator set startup.

Event History displays up to 100 stored system events including status, warnings, and shutdowns.

Last Start Date displays the date when the generator set last operated.

Number of Starts displays the total number of generator set startup events.

Number of Starts (Since) Last Maintenance displays the total number of generator set startup events since the last maintenance date.

Operating Days (Since) Last Maintenance displays the total number of days of operation since the last maintenance date. A counted day of operation can be 1–24 hours.

Run Time displays the total loaded hours, total unloaded hours, and total kW hours.

Run Time Since Maintenance displays the total loaded hours, total unloaded hours, and total kW hours.

Time Delay Displays (Menu 8)

The time delays are user adjustable. See Section 2.9.8, Menu 8—Time Delays, for time delay adjustments. See Section 1.3.1, Status Event and Fault Specifications, for range and default settings.

Crank On/Crank Pause displays the time allocated for generator set crank on and crank pause in minutes:seconds.

Engine Cooldown displays the time delay for engine cooldown while the master switch is in the AUTO or RUN positions and not in the idle mode.

Engine Start displays the time delay before the generator set starts while the master switch is in AUTO or RUN positions.

Overcrank Shutdown (Number of) Crank Cycles displays the number of unsuccessful crank cycles (crank on/crank pause) before the generator set shuts down on an overcrank fault.

Overvoltage displays the time delay before the generator set shuts down because of an overvoltage condition.

Starting Aid displays the engine starting aid activation time.

Undervoltage displays the time delay before the generator set shuts down because of an undervoltage condition.

1.2.3 Switches and Controls

See Figure 1-6 and Figure 1-8 for switches and controls.

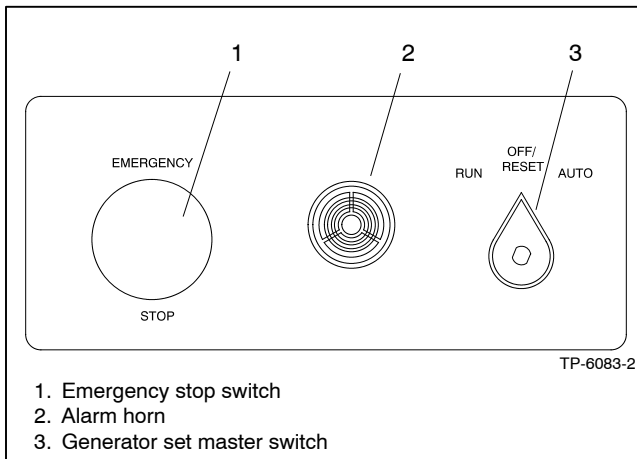

Figure 1-6 Switches and Alarm Horn

Note: Find additional switches and controls in Section 2.6.1, Keypad Operation.

Alarm Horn. The alarm horn alerts the operator or other attendants that a shutdown or warning condition exists. See Section 1.3, Controller Logic Specifications, for conditions. Place the generator set master switch in the AUTO position before silencing the alarm horn. The alarm horn cannot be silenced unless the generator set master switch is in the AUTO position. See Section 2.4.7, Controller Reset Procedure.

Alarm (Horn) Off. The keypad switch silences the alarm horn at the operator's discretion. Place the generator set master switch in the AUTO position before silencing the alarm horn. Restore alarm horn switches at all locations including those on remote annunciator and audiovisual alarm kits to the normal position after correcting the fault shutdown to avoid reactivating the alarm horn. See Section 2.4.7, Controller Reset Procedure.

AM/PM. This keypad switch provides time of day data entries when programming.

Emergency Stop. The operator-activated pushbutton immediately shuts down the generator set in emergency situations. Reset the emergency stop switch after shutdown by pulling the switch knob outward. *Use the emergency stop switch for emergency shutdowns only.* Use the generator set master switch for normal shutdowns.

Generator Set Master Switch (Run/Off-Reset/Auto). This switch resets the controller fault lamps and start/stops the generator set. Refer to Section 2.4.1, Starting, Section 2.4.2, Stopping, and Section 2.4.3, Emergency Stop Switch Reset Procedure.

The generator set master switch with the keyswitch option (Figure 1-7) is available to meet appropriate local code requirements. The key is removable in the AUTO position only.

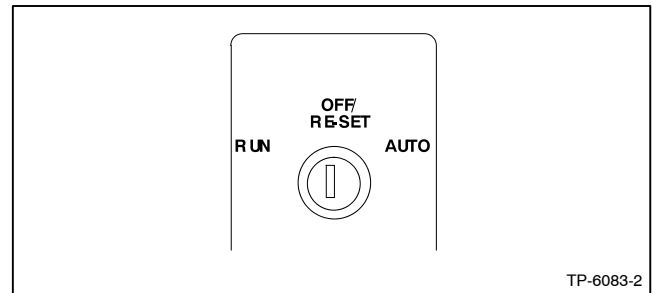

Figure 1-7 Generator Set Master Switch with Keyswitch Option

Lamp Test. The keypad switch tests the controller indicator lamps, horn, and digital display. Press the reset menu key before pressing the lamp test key.

Stop Prog (Program) Run. Keypad switch allows the user to stop any previously programmed generator set run sequence.

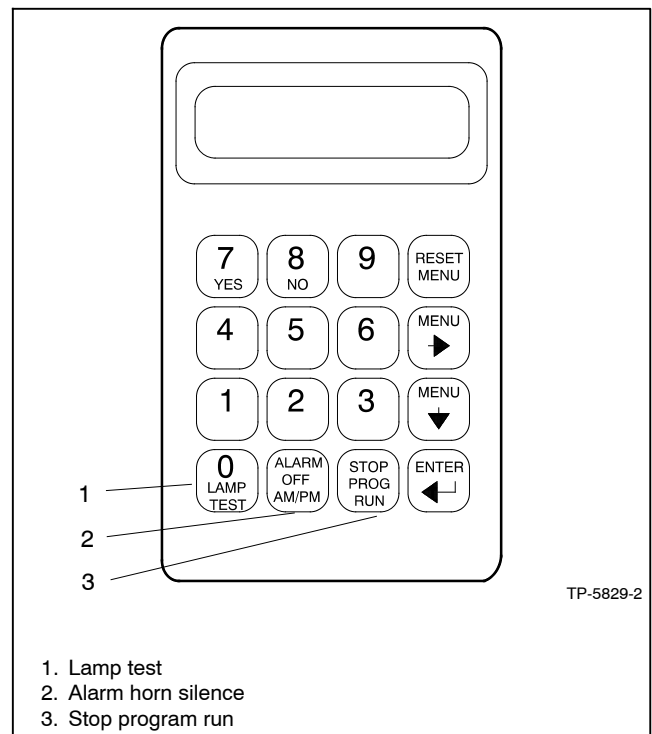

Figure 1-8 Keypad Switches

1.2.4 Controller Circuit Boards

The controller has five circuit boards—indicator, interconnection, keypad, digital display, and main logic/communication. See Figure 1-9 for circuit board locations.

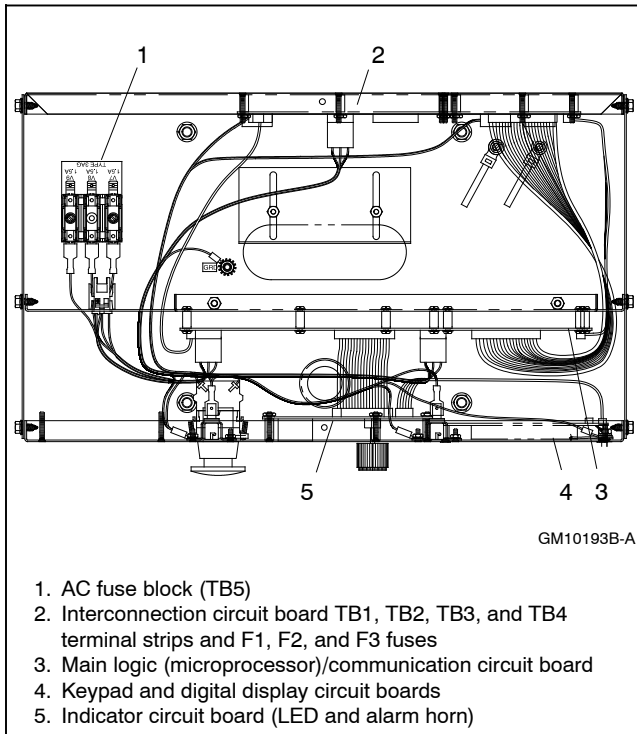

Figure 1-9 Controller Circuit Boards and Fuses (Controller Top View)

Indicator (Status) Circuit Board includes the LED status lamps, alarm horn, and generator set master switch.

Interconnection Circuit Board provides the terminal strips to connect the controller (customer) connection board and/or dry contact kits and three DC fuses (F1, F2, and F3). See 6.1.4 for more information.

Keypad (Switch Membrane) Circuit Board provides the keypad to navigate the generator set displays and enter data.

Digital Display Circuit Board provides the vacuum fluorescent display (VFD) for monitoring the generator set functions and output values.

Main Logic (Microprocessor)/Communication Circuit Board provides the controller operation logic and provides PC communication locally (direct) or remotely (via modem) using RS-232 or RS-485 connectors.

1.2.5 Fuses

AC Circuit Fuses (TB5). Fuses are located inside the controller. See Figure 1-9.

- **1.5-Amp (V7)** fuse protects L1 sensing input to interconnection circuit board.
- **1.5-Amp (V8)** fuse protects L2 sensing input to interconnection circuit board.
- **1.5-Amp (V9)** fuse protects L3 sensing input to interconnection circuit board.

DC Circuit Fuses fuses are located on the controller interconnection circuit board.

- **5-Amp Remote Annunciator (F1)** fuse protects the dry contact kit if equipped and the controller panel lamps.
- **5-Amp Controller (F2)** fuse protects the controller circuitry.
- **15-Amp Engine and Accessories (F3)** fuse protects the engine/starting circuitry and accessories.

1.2.6 Terminal Strips and Connectors

Terminal strips and connectors for inputs and outputs are located on the interconnection circuit board. See Section 6, Accessories.

TB1 Input Connection Terminal Strip provides input connections for remote start and emergency stop (E-Stop).

TB2 Analog Input Connection Terminal Strip provides analog input connections, including non-ECM sensor connections.

TB3 Accessory Power Output Connection Terminal Strips provides a generator set power supply for factory use.

TB4 Digital Input Connection Terminal Strips connect external devices (engine ECM and user supplied) to the generator set digital inputs.

P23 Connector connects the interconnection circuit board to the controller (customer) connection terminal strip (connector P25) inside the junction box. See 6.1.4 for more information.

Figure 1-10 shows locations of the terminal strips on the controller interconnection circuit board. See Section 6.2, Accessory and Connections, for specific terminal identification information. Refer to the wiring diagrams for additional information on connecting accessories to the terminal strips.

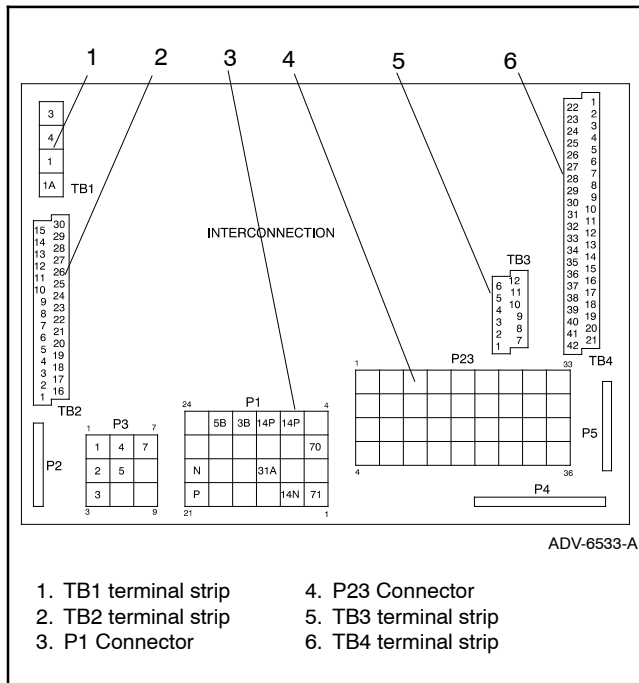

Figure 1-10 Interconnection Circuit Board Terminal Strips and Connectors

1.2.7 Circuit Board Interconnections for Calibration Procedure

The interconnection circuit board shown in Figure 1-11 contains a ribbon connector that requires disconnection during the calibration procedure in Menu 12—Calibration. Disconnect ribbon connector P2 prior to zeroing out (resetting) the auxiliary analog inputs.

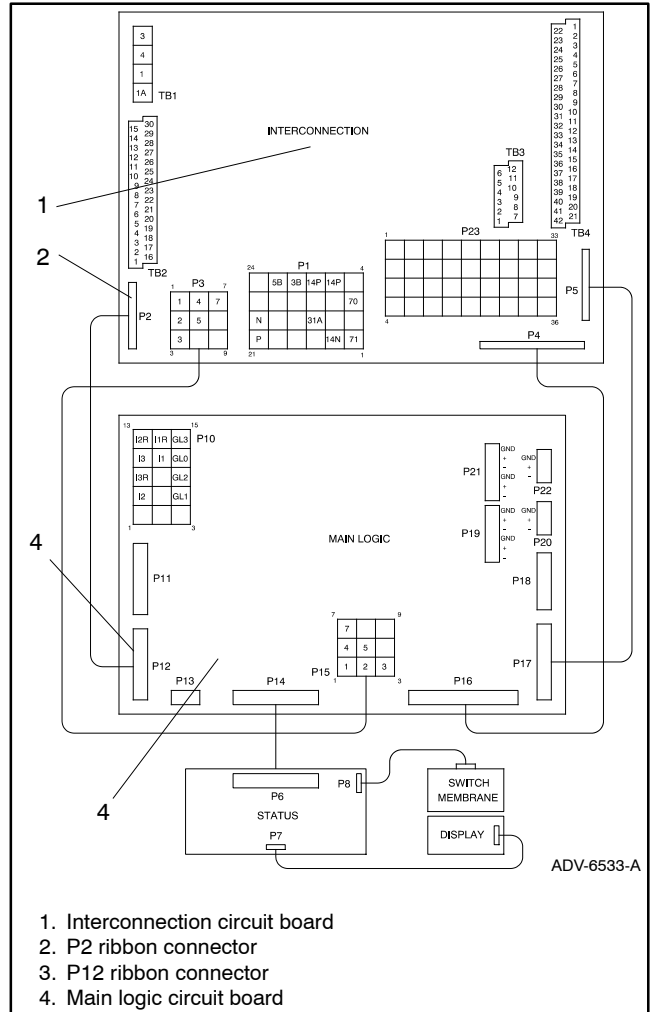

Figure 1-11 Interconnection Circuit Board Ribbon Connector P2 (Top View of Circuit Board)

1.2.8 Communication Ports

The main logic circuit board contains several communication ports for Modbus® and KBUS connections. See Figure 1-12. Refer to the List of Related Materials in the Introduction for corresponding communication installation information.

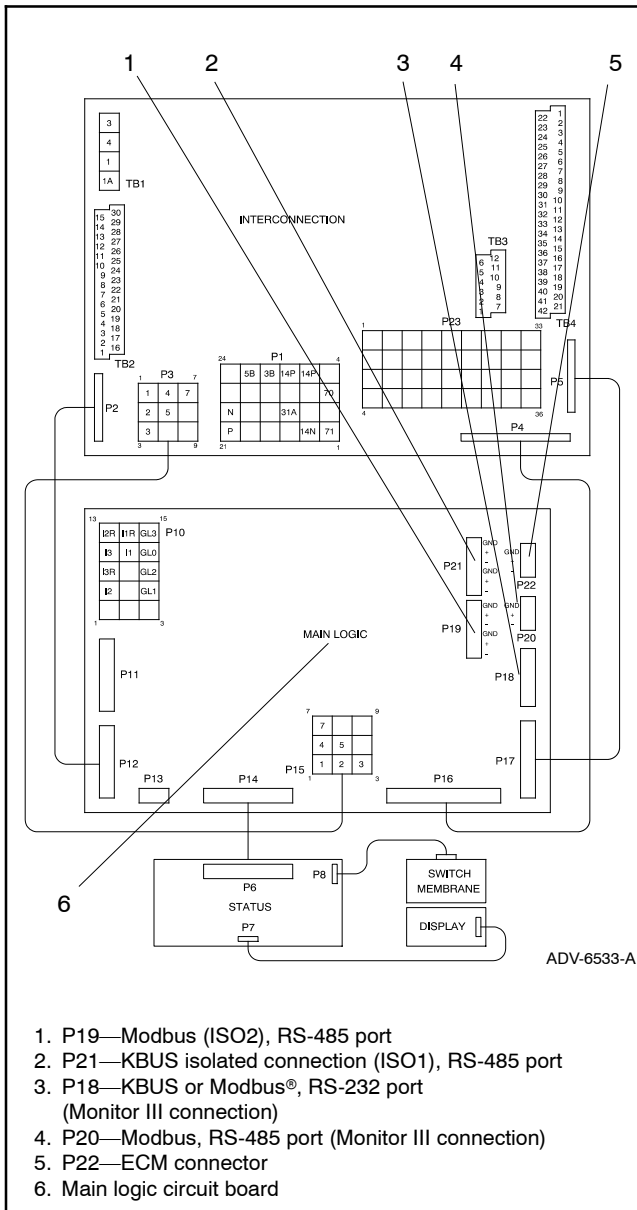

Figure 1-12 Main Logic Circuit Board Communication Ports (Top View of Circuit Board)

1.3 Controller Logic Specifications

The controller logic specifications section is an overview of the various features and functions of the controller. Certain features function only when optional accessories are connected. See Section 2, Operation, for details.

The default selection time delays and relay driver outputs (RDOs) are factory set and adjustable with the programming mode on (Menu 14). Some data entries require using a PC in the Remote Programming mode. See the monitor software operation manual for details.

Inhibit Time Delay. The inhibit time delay is the time period following crank disconnect during which the generator set stabilizes and the controller does not detect a fault or status event. Select the desired inhibit time delay from 0 to 60 seconds.

Time Delay (Shutdown or Warning). The time delay follows the inhibit time delay. The time delay is the time period between when the controller first detects a fault or status event and the controller warning or shutdown lamp illuminates. The delay prevents any nuisance alarms. Select the desired time delay from 0 to 60 seconds.

1.3.1 Status Event and Fault Specifications

The table starting on the next page contains all status events and faults with ranges and time delays including items that do not have adjustments.

Note: The engine ECM may limit the crank cycle even if the controller is set to a longer time period.

Factory-Defined Settings

Status Event or Fault	Refer to Menu	Digital Display	Relay Driver Output (RDO)	Alarm Horn	Lamp	Range Setting	Default Selection	Inhibit Time Delay (sec.)	Time Delay (sec.)
Access Code (password)	14					User-Selectable	0 (zero)		
AC Sensing Loss	10	AC SENSING LOSS	RDO-25 *	On	Warning				
Air Damper Control (if used) **	10								
Air Damper Indicator (if used), see D20 **									
Air/Fuel Module (AFM) Engine Start Delay †	10	AFM ENG START DELAY				Fixed			
Air/Fuel Module (AFM) Remote Start ‡	10	AFM REMOTE START	RDO-25 ‡	Off					
Air/Fuel Module (AFM) Shutdown (see D11) ‡									
Alternator Protection Shutdown	10	ALTERNATOR PROTECTION		On	Shutdown				
Analog Aux. Input 0	9	LOCAL BATT VDC				Fixed			
Analog Aux. Inputs A01-A07	9	USER-DEFINED A01-A07		On	Shutdown or Warning	Default Values with Warning Enabled: HI warning 90% LO warning 10% HI shutdown 100% LO shutdown 1%	30 sec. inhibit, 5 sec. delay	0-60	0-60
Analog Aux. Input A01 (non-ECM only)	9	A01 COOLANT TEMP		On	Shutdown or Warning	Default Values with Warning Enabled: HI/LO warning and HI/LO shutdown are all engine dependent	30 sec. inhibit, 0 sec. delay warning, 5 sec. delay shutdown		
Analog Aux. Input A02 (non-ECM only)	9	A02 OIL PRESSURE		On	Shutdown or Warning	Default Values with Warning Enabled: HI/LO warning and HI/LO shutdown are all engine dependent (255 psi max.)	30 sec. inhibit, 0 sec. delay warning, 5 sec. delay shutdown		
Analog Aux. Input A03 ‡	9	A03 INTAKE AIR TEMP			Shutdown or Warning	Default Values with Warning Enabled: HI/LO warning and HI/LO shutdown are all engine dependent	30 sec. inhibit, 0 sec. delay warning		
Analog Aux. Input A04 *	9	A04 FUEL LEVEL				Default Values with Warning Enabled: HI/LO warning are engine dependent	30 sec. inhibit, 0 sec. delay warning		
Analog Aux. Input A04 ‡	9	A04 OIL TEMP		On	Warning	Default Values with Warning Enabled: HI/LO warning are engine dependent	30 sec. inhibit, 0 sec. delay warning		
Analog Aux. Input A06 VSG (Volvo, GM, Doosan, KDI only)	9, 12	A06 ANALOG AUXILIARY IN		Off					
Analog Aux. Input A07	9	A07 ANALOG VOLT ADJUST				±10% of system voltage over the range of 0.5-4.5 VDC			

* All models, except Waukesha-powered models.

† Non-paralleling applications

‡ Waukesha-powered models

§ Paralleling applications

|| Denotes the default parameter range. Typically, ranges for the NiCad battery topology are slightly wider. For more details, refer to the battery charger operation manual.

** NFPA applications

†† DDC/MTU engine with MDEC/ADEC

‡‡ FAA only

Factory-Defined Settings

Status Event or Fault	Refer to Menu	Digital Display	Relay Driver Output (RDO)	Alarm Horn	Lamp	Range Setting	Default Selection	Inhibit Time Delay (sec.)	Time Delay (sec.)
Battery Charger Communication Error		CHRG COMM ERROR		On	Warning				
Battery Charger Fault (see D01) ** Note: On charger GM87448, Battery Charger Fault is communicated through CAN communication and D01 is not used.		BATTERY CHRGR FAULT		On	Warning				
Battery Charger Value Error		CHGR VAL ERROR		On	Warning				
Battle Switch (Fault Shutdown Override Switch)	9	BATTLE SWITCH		Off	Warning	Fixed			
Block Heater Control ††	10	BLOCK HEATER CONTROL	RDO only						
Breaker Trip §	10	BREAKER TRIP	RDO-30	Off	Warning				
Charger Absorption Current Termination Target (A)	18	ABSORPTION TERMINATION				1 – 5	2		
Charger Automatic Equalize Enable Note: Equalize is only available with FLA/VRLA topology selected.	18	AUTOMATIC EQUALIZE ENABLED				Active Inactive	Inactive		
Charger Charge Cycles Between Auto Equalize Cycles Note: Equalize is only available with FLA/VRLA topology selected.	18					0 – 99			
Charger Custom Profile Enable	18	CUSTOM CHARGING PROFILE ENABLE				Active Inactive	Inactive		
Charger Depleted Battery Current Limit	18					1 – 5	2		
Charger Depleted Battery Voltage Target	18					4 – 12 (12 V) 18 – 24 (24 V)	10 (12 V) 20 (24 V)		
Charger Equalize Stage Duration (Min) Note: Equalize is only available with FLA/VRLA topology selected.	18					60 – 480			
* All models, except Waukesha-powered models. † Non-paralleling applications ‡ Waukesha-powered models § Paralleling applications Denotes the default parameter range. Typically, ranges for the NiCad battery topology are slightly wider. For more details, refer to the battery charger operation manual.					** NFPA applications †† DDC/MTU engine with MDEC/ADEC ‡‡ FAA only				

Factory-Defined Settings

Status Event or Fault	Refer to Menu	Digital Display	Relay Driver Output (RDO)	Alarm Horn	Lamp	Range Setting	Default Selection	Inhibit Time Delay (sec.)	Time Delay (sec.)
Charger Manual Equalize Cycle Activation Note: Equalize is only available with FLA/VRLA topology selected.	18	MANUAL EQUALIZE ACTIVE				Active Inactive	Inactive		
Charger Maximum Absorption Time Threshold (Min.)	18	MAX ABSORPTION TIME				60 – 360 60 – 600 (NiCad only)	240		
Charger Maximum Bulk Time Threshold (Min)	18	MAX BULK TIME				60 – 600	480		
Charger Refresh Charge Cycle Time (Hr)	18					0, 23 – 672	335		
Charger Return To Bulk State Voltage Threshold (V)	18	BULK STATE RETURN VOLTAGE				10 – 13 (12 V) 20 – 26 (24 V)	12.8 (12 V) 25.6 (24 V)		
Charger Starter Battery Topology Note: Verify that the battery topology is set correctly for the battery type that is used. Incorrect charger output system voltage may cause irreversible damage to the battery and abnormal out gassing.	18	BATTERY TOPOLOGY				Default FLA/VRLA AGM Gel NiCad	Default		
Charger System Battery Voltage Note: Verify that the system voltage is set correctly for the battery type that is used. Incorrect charger output system voltage may cause irreversible damage to the battery and abnormal out gassing.	18	CHARGER SYSTEM VOLTAGE				System 12 VDC System 24 VDC	12 VDC		
Charger Temperature Compensation Enable	18	TEMP COMPENSATION ENABLED				Active Inactive	Inactive		
Charger Temperature Compensation Slope (mV/°C)	18	TEMPERATURE COMP SLOPE				-40 – 0 (12 V) -80 – 0 (24 V)	-30 (12 V) -60 (24 V)		
* All models, except Waukesha-powered models. † Non-paralleling applications ‡ Waukesha-powered models § Paralleling applications Denotes the default parameter range. Typically, ranges for the NiCad battery topology are slightly wider. For more details, refer to the battery charger operation manual.			** NFPA applications †† DDC/MTU engine with MDEC/ADEC ‡‡ FAA only						

Factory-Defined Settings

Status Event or Fault	Refer to Menu	Digital Display	Relay Driver Output (RDO)	Alarm Horn	Lamp	Range Setting	Default Selection	Inhibit Time Delay (sec.)	Time Delay (sec.)
Charger Voltage Absorption (V)	18	ABSORPTION VOLTAGE				13 – 15 (12 V) 26 – 30 (24 V)	14.25 (12 V) 28.5 (24 V)		
Charger Voltage Bulk (V)	18	BULK VOLTAGE				13 – 15 (12 V) 26 – 30 (24 V)	14.25 (12 V) 28.5 (24 V)		
Charger Voltage Equalize (V) Note: Equalize is only available with FLA/VRLA topology selected.	18	EQUALIZE VOLTAGE				14 – 16 (12 V) 28 – 32 (24 V)			
Charger Voltage Float (V)	18	FLOAT VOLTAGE				13 – 14 (12 V) 26 – 28 (24 V)	13.25 (12 V) 26.5 (24 V)		
Common Protective Relay Output §	10	COMMON PR OUTPUT	RDO-31 §	Off	Warning				
Critical Overvoltage Shutdown	10	CRITICAL OVERVOLTAGE		On	Shutdown	Fixed	275 volts (L1-L2)		
Cyclic Cranking	8			Off		1-6 crank cycles 10-30 sec. crank on 1-60 sec. pause	3 15 sec. 15 sec.		
Defined Common Faults (each input value is set separately)	10	DEFINED COMMON FAULT	RDO-18 (lead 32A)	On	Shutdown or Warning	Default shutdowns include: Emergency stop High coolant temp Low oil pressure Overcrank Overspeed	30 sec. inhibit, 5 sec. delay	0-60	0-60
Detonation Shutdown (see D13) †									
Detonation Warning (see D12) †									
Digital Aux. Input D01-D21	9, 10	USER-DEFINED D01-D21		On	Shutdown or Warning		30 sec. inhibit, 5 sec. delay	0-60	0-60
Digital Aux. Input D01 Battery Charger Fault ** (On charger GM87448, Battery Charger Fault is communicated through CAN communication and D01 is not used.)	9, 10	D01 BATTERY CHARGER FAULT	RDO-11 (lead 61)	On	Warning	Fixed	0 sec. inhibit, 0 sec. delay		
Digital Aux. Input D02 Low Fuel Warning **	9, 10	D02 LOW FUEL WARNING	RDO-08 (lead 63)	On	Warning	Fixed	0 sec. inhibit, 0 sec. delay		
Digital Aux. Input D03 Low Coolant Temperature **	9, 10	D03 LOW COOLANT TEMP	RDO-05 (lead 35)	On	Warning	Fixed	0 sec. inhibit, 0 sec. delay		
* All models, except Waukesha-powered models. † Non-paralleling applications ‡ Waukesha-powered models § Paralleling applications					** NFPA applications †† DDC/MTU engine with MDEC/ADEC ‡‡ FAA only				
Denotes the default parameter range. Typically, ranges for the NiCad battery topology are slightly wider. For more details, refer to the battery charger operation manual.									

Factory-Defined Settings

Status Event or Fault	Refer to Menu	Digital Display	Relay Driver Output (RDO)	Alarm Horn	Lamp	Range Setting	Default Selection	Inhibit Time Delay (sec.)	Time Delay (sec.)
Digital Aux. Input D04 Field Overvoltage (M4, M5, M7, or M10 alt. only)	9, 10	D04 FIELD OVERVOLTAGE		On	Shutdown	Fixed	1 sec. inhibit, 15 sec. delay		
Digital Aux. Input D05 Breaker Closed §	9, 10	D05 BREAKER CLOSED		Off	Warning	Fixed	0 sec. inhibit, 0 sec. delay		
Digital Aux. Input D06 §	9, 10	D06 ENABLE SYNCH					20 sec. inhibit, 0 sec. delay		
Digital Aux. Input D09 Low Fuel Pressure Shutdown (125RZG only)	9, 10	D09 LOW FUEL SHUTDOWN		On	Shutdown	Fixed	5 sec. inhibit, 0 sec. delay		
Digital Aux. Input D11 Air/Fuel Module (AFM) Shutdown ‡	9, 10	D11 AFM SHUTDOWN		On	Shutdown	Fixed	0 sec. inhibit, 0 sec. delay		
Digital Aux. Input D12 Detonation Warning ‡	9, 10	D12 DETON WARNING		On	Warning	Fixed	2 sec. inhibit, 0 sec. delay		
Digital Aux. Input D13 Detonation Sensing Module (DSM) Shutdown ‡	9, 10	D13 DETON SHUTDOWN		On	Shutdown	Fixed	0 sec. inhibit, 0 sec. delay		
Digital Aux. Input D13 Knock Detection Module (KDM) Shutdown ‡	9, 10	D13 KNOCK SHUTDOWN		On	Shutdown	Fixed	0 sec. inhibit, 0 sec. delay		
Digital Aux. Input D14 Low Coolant Level, (with LCL switch) **	9, 10	D14 LOW COOLANT LVL	RDO-19	On	Shutdown	Fixed	30 sec. inhibit, 5 sec. delay		
Digital Aux. Input D15 Remote Shutdown	9, 10	D15 REMOTE SHUTDOWN		On	Shutdown		0 sec. inhibit, 0 sec. delay		
Digital Aux. Input D16 Remote Reset	9, 10								
Digital Aux. Input D17 VAR/PF mode	9, 10								
Digital Aux. Input D18 Voltage Lower	9, 10								
Digital Aux. Input D19 Voltage Raise	9, 10								
Digital Aux. Input D20 Air Damper Indicator (if used) **	9, 10	D20 AIR DAMPER	RDO-23 * (lead 56)	On	Shutdown	Fixed	0 sec. inhibit, 0 sec. delay		
Digital Aux. Input D21 Idle (speed) Mode Function	9, 10	D21 IDLE MODE ACTIVE	RDO-21	Off	Warning	Fixed inhibit time	0 sec. inhibit, 60 sec. delay		0-600 or 9:99 for infinity
ECM Red Alarm (was MDEC Red Alarm) ††	10	ECM RED ALARM		On	Shutdown				
ECM Yellow Alarm (was MDEC Yellow Alarm) ††	10	ECM YELLOW ALARM		On	Warning				
EEPROM Write Failure	10	EEPROM WRITE FAILURE		On	Shutdown				

* All models, except Waukesha-powered models.

** NFPA applications

† Non-paralleling applications

†† DDC/MTU engine with MDEC/ADEC

‡ Waukesha-powered models

‡‡ FAA only

§ Paralleling applications

|| Denotes the default parameter range. Typically, ranges for the NiCad battery topology are slightly wider. For more details, refer to the battery charger operation manual.

Factory-Defined Settings

Status Event or Fault	Refer to Menu	Digital Display	Relay Driver Output (RDO)	Alarm Horn	Lamp	Range Setting	Default Selection	Inhibit Time Delay (sec.)	Time Delay (sec.)
Emergency Stop Shutdown	10	EMERGENCY STOP	RDO-14 (lead 48)	On	Shutdown				
Engine Cooldown (see Time Delay-)									
Engine Derate Active	10	ENGINE DERATE ACTIVE							
(Engine) J1939 CAN Shutdown (ECM only)	10	J1939 CAN SHUTDOWN		On	Shutdown				
Engine Stalled (ECM only)	10	ENGINE STALLED		On	Shutdown				
Engine Start (see Time Delay-)									
EPS (Emergency Power System) Supplying Load	10	EPS SUPPLYING LOAD	RDO-22	Off	Warning	Fixed	1% of rated line current		
Equalize Current Limit (A) Note: Equalize is only available with FLA/VRLA topology selected.	18					1-5			
Field Overvoltage (see D04)									
Forced Charge Cycle Reset	18					Active Inactive	Inactive		
Fuel Level (see A04)									
Fuel Valve Relay ‡	10	FUEL VALVE RELAY	RDO-23 ‡						
Generator Set Running	10		RDO-15 (lead 70R)	Off					
Ground Fault Detected	10	GROUND FAULT		On	Warning				
High Battery Voltage	10	HIGH BATTERY VOLTAGE	RDO-13	Off	Warning	14.5-16.5 V (12 V) 29-33 V (24 V)	16 V (12 V) 32 V (24 V)		10
High Coolant Temperature Shutdown	10	HI COOL TEMP SHUTDOWN	RDO-03 (lead 36)	On	Shutdown			30	5
High Coolant Temperature Warning	10	HI COOL TEMP WARNING	RDO-06 (lead 40)	On	Warning			30	
High Oil Temperature Shutdown	10	HI OIL TEMP SHUTDOWN		On	Shutdown			30	5
High Oil Temperature Warning ‡ ††	10	HI OIL TEMP WARNING		On	Warning			30	
Idle (speed) Mode Function (see D21)									
In Synch §	10	IN SYNCH	RDO-29 *						
Intake Air Temperature Shutdown ††	10	INTAKE AIR TEMP SDWN		On	Shutdown			30	

* All models, except Waukesha-powered models.

† Non-paralleling applications

‡ Waukesha-powered models

§ Paralleling applications

|| Denotes the default parameter range. Typically, ranges for the NiCad battery topology are slightly wider. For more details, refer to the battery charger operation manual.

** NFPA applications

†† DDC/MTU engine with MDEC/ADEC

‡‡ FAA only

Factory-Defined Settings

Status Event or Fault	Refer to Menu	Digital Display	Relay Driver Output (RDO)	Alarm Horn	Lamp	Range Setting	Default Selection	Inhibit Time Delay (sec.)	Time Delay (sec.)
Intake Air Temperature Warning ††	10	INTAKE AIR TEMP WARN		On	Warning			30	
Intake Air Temp Warning (see A03) ‡									
Intake Air Temp Shutdown (see A03)‡									
Internal Fault Shutdown	10	INTERNAL FAULT		On	Shutdown				
J1939 CAN Shutdown (see Engine J1939 CAN Shutdown)									
Knock Shutdown (see D13) ‡									
kW Overload (see Load Shed)									
Load Shed kW Overload ‡‡	10	LOAD SHED KW OVER	RDO-30 ‡‡	Off	Warning	80%-120%	100% of kW rating with 5 sec. delay		2-10
Load Shed Over Temperature †† (Activated by a High Coolant Temp. shutdown)	10	LOAD SHED OVER TEMPERATURE	RDO only						
Load Shed Underfrequency †	10	LOAD SHED UNDER FREQUENCY	RDO-31 †	Off	Warning		59 Hz (60 Hz) 49 Hz (50 Hz)		5
Locked Rotor Shutdown	10	LOCKED ROTOR		On	Shutdown				
Loss of ECM Communication (ECM only)	10	LOSS OF ECM COMM	RDO-26 *	On	Shutdown				4
Loss of Field Shutdown §	10	SD LOSS OF FIELD		On	Shutdown				
Low Battery Voltage	10	LOW BATTERY VOLTAGE	RDO-12 (lead 62)	Off	Warning	10-12.5 V (12 V) 20-25 V (24 V)	12 V (12 V) 24 V (24 V)	0	10
Low Coolant Level (see D14) (with LCL switch) **									
Low Coolant Temperature (see D03) **									
Low Coolant Temperature Shutdown ††	10	LOW COOLANT TEMP SHUTDOWN		On	Shutdown				
Low Fuel (Level or Pressure) Warning (see D02) **									
Low Fuel Pressure Shutdown (see D09) (125RZG only)									
(Low) Oil Pressure Shutdown	10	OIL PRESSURE SHUTDOWN	RDO-04 (lead 38)	On	Shutdown			30	5

* All models, except Waukesha-powered models.

** NFPA applications

† Non-paralleling applications

†† DDC/MTU engine with MDEC/ADEC

‡ Waukesha-powered models

‡‡ FAA only

§ Paralleling applications

|| Denotes the default parameter range. Typically, ranges for the NiCad battery topology are slightly wider. For more details, refer to the battery charger operation manual.

Factory-Defined Settings

Status Event or Fault	Refer to Menu	Digital Display	Relay Driver Output (RDO)	Alarm Horn	Lamp	Range Setting	Default Selection	Inhibit Time Delay (sec.)	Time Delay (sec.)
(Low) Oil Pressure Warning	10	OIL PRESSURE WARNING	RDO-07 (lead 41)	On	Warning			30	
Maintenance Due	10	MAINTENANCE DUE							
Master Not In Auto (Generator Set Switch)	10	MASTER NOT IN AUTO	RDO-09 (lead 80)	On	Warning and Not In Auto				
Master Switch Error	10	MASTER SWITCH ERROR		On	Shutdown				
Master Switch to Off	10	MASTER SWITCH TO OFF		On	Shutdown and Not in Auto				
Master Switch Open	10	MASTER SWITCH OPEN		On	Shutdown				
NFPA 110 Fault **	10	NFPA 110 FAULT	RDO-10 (lead 32)	On	Shutdown or Warning				
No Air Temperature Signal Warning ‡	10	NO AIR TEMP SIGNAL		On	Warning			30	4
No Coolant Temperature Signal	10	NO COOL TEMP SIGNAL		On	Shutdown			30	4
No Oil Pressure Signal	10	NO OIL PRESSURE SIGNAL		On	Shutdown			30	4
No Oil Temperature Signal Warning ‡	10	NO OIL TEMP SIGNAL		On	Warning			30	4
Output Enable	18					Fixed	Active		
Overcrank Shutdown	8, 10	OVER CRANK	RDO-02 (lead 12)	On	Shutdown	0-6 Cycles	3 Cycles		
Overcurrent	10	OVER CURRENT		On	Warning		110%		10
Over Current PR Shutdown §	10	SD OVER CURRENT PR		On	Shutdown				
Overfrequency Shutdown	7, 10	OVER FREQUENCY	RDO-28	On	Shutdown	102%-140%	110% Std. 103% FAA		10
Over Power Shutdown §	10	SD OVER POWER		On	Shutdown		102% Stdby 112% Prime		
Overspeed Shutdown	7, 10	OVER SPEED	RDO-01 (lead 39)	On	Shutdown	65-70 Hz (60 Hz) 55-70 Hz (50 Hz)	70 (60 Hz) 70 (50 Hz)		0.25
Overvoltage Shutdown	7, 8, 10	OVER VOLTAGE	RDO-20 (lead 26)	On	Shutdown	105%-135% of nominal	115% 2-sec time delay † 135% 10-sec time delay §		2-10
Password (see Access Code)									
Pre Lube Relay ‡	10	PRE LUBE RELAY	RDO-26 ‡						4
Remote Reset (see D16)									
Remote Shutdown (see D15)									

* All models, except Waukesha-powered models.

† Non-paralleling applications

‡ Waukesha-powered models

§ Paralleling applications

|| Denotes the default parameter range. Typically, ranges for the NiCad battery topology are slightly wider. For more details, refer to the battery charger operation manual.

** NFPA applications

†† DDC/MTU engine with MDEC/ADEC

‡‡ FAA only

Factory-Defined Settings

Status Event or Fault	Refer to Menu	Digital Display	Relay Driver Output (RDO)	Alarm Horn	Lamp	Range Setting	Default Selection	Inhibit Time Delay (sec.)	Time Delay (sec.)
Reverse Power Shutdown §	10	SD REVERSE POWER		On	Shutdown				
Speed Sensor Fault	10	SPEED SENSOR FAULT	RDO-24	On	Warning				
Starting Aid (see Time Delay Starting Aid)									
System Ready	10		RDO-17 (lead 60)	Off	System Ready				
Time Delay Engine Cooldown (TDEC)	8, 10	DELAY ENG COOLDOWN	RDO-16 (lead 70C)	Off		00:00-10:00 min:sec	5:00		
Time Delay Engine Start (TDES)	8, 10	DELAY ENG START		Off		00:00-5:00 min:sec	00:01		
Time Delay Starting Aid	8, 10			Off		0-10 sec.			
Turbocharger Temperature Shutdown (1750/2000REOZMD)	10	TURBO TEMP SHUTDOWN		On	Shutdown			30	
Turbocharger Temperature Warning (1750/2000REOZMD)	10	TURBO TEMP WARNING		On	Warning			30	
Underfrequency	7, 10	UNDER FREQUENCY	RDO-29 ‡	On	Shutdown	80%-97%	97% FAA 90% † 80% §		10
Undervoltage Shutdown	7, 8, 10	UNDER VOLTAGE	RDO-27	On	Shutdown	70%-95%	85% 10-sec time delay † 70% 30-sec time delay §		5-30
Variable Speed Governor (VSG) (see A06)									
VAR/PF Mode (see D17)									
Voltage Lower (see D18)									
Voltage Raise (see D19)									
Weak Battery	10	WEAK BATTERY		Off	Warning		60% of nominal		2
* All models, except Waukesha-powered models. † Non-paralleling applications ‡ Waukesha-powered models § Paralleling applications					** NFPA applications †† DDC/MTU engine with MDEC/ADEC ‡‡ FAA only				
Denotes the default parameter range. Typically, ranges for the NiCad battery topology are slightly wider. For more details, refer to the battery charger operation manual.									

Calibration	Refer to Menu	Digital Display	Range Setting	Default Selection
Voltage Adjustment	11	VOLT ADJ	±10% of system voltage— Version 2.10 ±20% of system voltage— Version 2.11 or higher	System voltage
Underfrequency Unload Frequency Setpoint	11	FREQUENCY SETPOINT	40 to 70 Hz	1 Hz below system frequency (ECM) 2 Hz below system frequency (non-ECM)
Underfrequency Unload Slope	11	SLOPE	0–10% of rated voltage volts per cycle	3.1% of system voltage
Reactive Droop	11	VOLTAGE DROOP	0–10% of system voltage	4% of system voltage
VAR Control	11	KVAR ADJ	0 to rated kVAR generating 0 to 35% of rated kVAR absorbing	0
Power Factor (PF) Adjust Control	11	PF ADJ	0.7 to 1.0 leading 0.6 to 1.0 lagging	0.8 lagging
Controller Gain	11	REGULATOR GAIN	1–10000	100
VAR/PF Gain or Utility Stability	11	VAR/PF GAIN	1–10000	100

Figure 1-13 Settings for Controller Internal Voltage Regulation

1.3.2 Voltage Regulator and Calibration Specifications

The 550 controller has a voltage regulation function that is internal to the processor. This means that no external voltage regulator is necessary. The voltage regulation of the controller uses root mean square (rms) sensing for fast response to changes in indicated and regulated voltages resulting in excellent regulation accuracy.

RMS voltage regulation is available for both paralleling and utility application to control changes in the reactive loads due to load changes, prime mover speed variation, thermal drift, and other variations. See Figure 1-13 for data on the 550 controller voltage regulation. Refer to Appendix C to customize adjustments for specific applications.

1.3.3 Voltage Regulator Adjustments

The descriptions of the voltage regulator adjustments and features follow. See Appendix C, Voltage Regulator Definitions and Adjustments, for additional information.

Voltage Adjustment. The voltage adjustment allows the user to *enter the desired generator set output level*. This regulated level setting is the average of the three line-to-line voltages in three-phase configurations or L1-to-L2 in single phase configurations.

Submenus display the individual line-to-line voltages. These voltages are for reference only and are relevant in unbalanced load conditions. The voltage adjust setpoint can be changed to accommodate an important phase in an unbalanced system.

Underfrequency Unload Frequency Setpoint. This adjustment affects the voltage droop (volts per Hz) when load is applied and underfrequency occurs. The underfrequency unload setting defines the *setpoint where underfrequency starts*. Any frequency below the setpoint causes the voltage to drop thus reducing the load allowing the engine speed to recover according to the underfrequency unload slope setting.

Engine speed recovery depends upon characteristics such as engine make, fuel type, load types, and operating conditions. The underfrequency unload setting should match the engine speed recovery characteristics for the application.

Underfrequency Unload Slope. This setting determines how much the voltage drops during an underfrequency condition. Typically, applying a large electrical load causes a dip in engine speed and frequency. The voltage regulator reduces voltage, allowing engine speed recovery. The volts-per-Hz setting determines the *amount of voltage drop*.

Reactive Droop. Reactive droop compensation provides reactive current flow adjustment in the generator set during generator set-to-generator set paralleling applications. Reactive droop reduces excitation levels with increasing reactive current. A reduced excitation level reduces generator set reactive current or generated VARs, improving reactive load sharing.

Enter the gain setting as a *percentage of system voltage* when full-rated load with 0.8 power factor is applied.

Any loads less than full load force the voltage to drop by the ratio of reactive volt-amps (VARs) to rated VARs.

VAR Control. VAR control is used in some utility paralleling applications. The excitation is regulated to maintain the reactive load rather than output voltage. The VAR adjust setting determines what reactive load is maintained at the generator set output. The VAR adjust is the total reactive load (sum of three phases).

VAR control allows the user to define the direction of the reactive current out of the generator set (generating) or into the generator set (absorbing).

The utility supply, not the controller, determines terminal voltage. Engine fueling determines real power, measured in watts, using load sharing module control.

Power Factor (PF) Adjust Control. Power factor control is used in some utility paralleling applications. The excitation is regulated to maintain PF rather than output voltage. The PF adjustment setting determines what PF is maintained at the generator set output. PF adjustment is the average of three phases.

Power factor is defined as the ratio of real power (watts) over the volt-amps. Power factor can be calculated as the cosine of the electrical angle between current and voltage. The cosine function is positive for angles between -90° and $+90^\circ$ including zero; and is negative for angles between -90 and $+90$ including 180° . This adjustment requires the user to determine whether the current leads or lags the voltage.

Regulator Gain. Regulator gain refers to the gain of the control system. Generally, the higher the gain the faster the system responds to changes and the lower the gain, the more stable the system.

If the voltage is slow the recover when loads are applied or removed, increase the regulator gain. If the voltage is unstable, decrease the regulator gain. Regulator gain is active only while not in the VAR/PF mode.

VAR/PF Gain. The VAR/PF gain also refers to the gain of the control system. Unlike the regulator gain, the response and stability of the system refers to the reactive current, or more specifically the VARs and/or power factor.

If the system is slow to recover to the desired VAR or PF setting, increase the VAR/PF gain. If the VARs or PF of the system is unstable, decrease the VAR/PF gain. Because VAR/PF stability can be effected by the prime mover (engine), VAR/PF gain adjustments should be coordinated with the load sharing adjustment.

Analog Voltage Adjust. Use Menu 11 to enable or disable analog voltage adjust. Analog voltage adjust is commonly used for active control of voltage by some external equipment in certain applications, like synchronizing.

Enabling analog voltage adjust allows slight adjustment to the operating voltage by use of auxiliary analog input #7. This input signal provides a bias to the voltage adjust value. The range of input voltage is 0-5 VDC nominal (0.1-4.9 actual). The corresponding range of bias is approximately $\pm 10\%$ of nominal or system voltage. If the input voltage is at the midpoint (2.5 volts), the bias is zero and the regulation value will be equal to the voltage adjust value entered by the user in Menu 11 or the system voltage if no value was entered by the user. Likewise, if the input voltage is out of range (below 0.1 volt or above 4.9 volts), the bias will be zero. For every 1 volt of input voltage, the operating voltage will vary approximately 4%; this satisfies the nominal ratio of approximately $\pm 10\%$ output voltage for 0-5 volts input.

When analog voltage adjust is enabled, the description shown for Auxiliary Analog Input 7 is *Analog Volt Adjust*. Enable analog voltage adjust via KNET or MODBUS by setting the description for Analog Input 7 as *Analog Volt Adjust*.

Analog voltage adjust may be enabled only when the master switch is in the OFF/RESET or AUTO positions and while the generator is not running.

2.1 Prestart Checklist

To ensure continued satisfactory operation, perform the following checks or inspections before or at each startup, as designated, and at the intervals specified in the service schedule. In addition, some checks require verification after the unit starts.

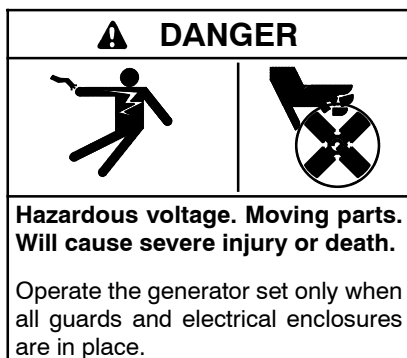

Air Cleaner. Check for a clean and installed air cleaner element to prevent unfiltered air from entering engine.

Air Inlets. Check for clean and unobstructed air inlets.

Battery. Check for tight battery connections. Consult the battery manufacturer's instructions regarding battery care and maintenance.

Controller. After reconnecting the battery, set the controller time and date. See Section 2, Menu 14—Programming Mode On and Menu 6—Time and Date.

Coolant Level. Check the coolant level according to the cooling system maintenance information.

Note: Block Heater Damage. The block heater will fail if the energized heater element is not immersed in coolant. Fill the cooling system before turning on the block heater. Run the engine until it is warm, and refill the radiator to purge the air from the system before energizing the block heater.

Drive Belts. Check the belt condition and tension of the radiator fan, water pump, and battery charging alternator belt(s) according to the drive belt system maintenance information.

Exhaust System. Check for exhaust leaks and blockages. Check the silencer and piping condition and check for tight exhaust system connections.

Inspect the exhaust system components (exhaust manifold, exhaust line, flexible exhaust, clamps, silencer, and outlet pipe) for cracks, leaks, and corrosion.

- Check for corroded or broken metal parts and replace them as needed.
- Check for loose, corroded, or missing clamps and hangers. Tighten or replace the exhaust clamps and/or hangers as needed.
- Check that the exhaust outlet is unobstructed.
- Visually inspect for exhaust leaks (*blowby*). Check for carbon or soot residue on exhaust components. Carbon and soot residue indicates an exhaust leak. Seal leaks as needed.

Fuel Level. Check the fuel level and keep the tank(s) full to ensure adequate fuel supply.

Oil Level. Maintain the oil level at or near, not over, the full mark on the dipstick.

Operating Area. Check for obstructions that could block the flow of cooling air. Keep the air intake area clean. Do not leave rags, tools, or debris on or near the generator set.

2.2 Exercising Generator Set

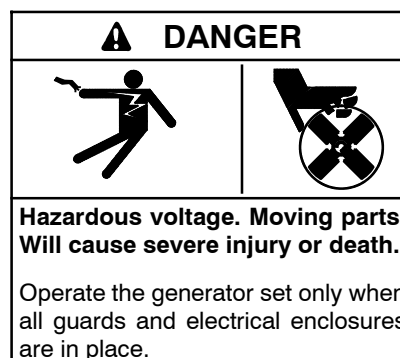

Operate the generator set under load once each week for one hour. Perform the exercise in the presence of an operator when the generator set does not have a programmed exercise mode or an automatic transfer switch with an exercise option.

During the exercise period apply a minimum of 35% load based on the nameplate standby rating, unless otherwise instructed in the engine operation manual.

The operator should perform all of the prestart checks before starting the manual exercise procedure. Start the generator set according to the starting procedure in Section 2.4, Controller Operation. While the generator set is operating, listen for a smooth-running engine and visually inspect generator set for fluid or exhaust leaks.

The generator set exercise time can be programmed for a one-time exercise period. See Menu 4—Operational Records. The generator set controller does not provide weekly scheduled exercise periods. For scheduled exercise periods, refer to the automatic transfer switch (if equipped) literature.

2.3 Operation in Cold Weather Climates

Cold weather operation is generally considered ambient temperatures below freezing 0°C (32°F). The following items are recommended for cold weather starting and/or operation when the unit is located in an enclosure or unheated structure. Have a licensed electrician install 120 VAC, 15 amp outlets as needed if not already in the immediate area.

Refer to the engine operation manual regarding engine oil viscosity, fuel composition, and coolant mixture recommendations.

- The **engine block heater** is generally recommended for most units when operated below 0°C (32°F) and required as part of NFPA 110. Refer to the respective spec sheet for temperature recommendations in available options.
- A **battery heater** is generally recommended for most units when operated below 0°C (32°F). Refer to the respective spec sheet for model availability.
- An **alternator strip heater** is available for most generator sets providing a heat source to prevent moisture and frost buildup.
- The **crankcase ventilation (CCV) heater kit** provides a controlled heating source to the crankcase ventilation system preventing freezing water buildup during cold weather. The thermostat turns on at 4°C (40°F) and turns off at 16°C (60°F). Refer to Section 3, Scheduled Maintenance for more information. (Applies to 125/150 kW, 8.1 L GM- and 8.8 L PSI- powered generator set models only.)
- **Heater tape** is recommended when the generator set is equipped with a closed crankcase ventilation system and operated at or below 50% of rated load. Wrap the UL/CSA compliant heater tape around the crankcase canister/breather system hose that runs from the crankcase to the air intake and use cable ties as needed to secure the heater tape. If the heater tape is within 152 mm (6 in.) of the exhaust system, use thermal insulation material to protect the heater tape.

40-60REOZK Models only. When the ambient temperature drops below -15°C (5°F) a turbocharger pre-lube sequence begins when the crank cycle is

initiated. During the first 10 seconds of cranking, the fuel system is disabled to ensure engine oil is present at the turbocharger. This is necessary for the longevity of the turbocharger on the KDI 3404TM engine. The fuel system is then enabled for the next 5 seconds of cyclic cranking and the engine will start as normal.

2.4 Controller Operation

2.4.1 Starting

Local Manual Starting

Move the generator set master switch to the RUN position to start the generator set at the controller.

Note: The alarm horn sounds and the Not-In-Auto lamp lights whenever the generator set master switch is not in the AUTO position.

Note: The transient start/stop function of the controller prevents accidental cranking of the rotating engine. The generator set stops and re cranks when the generator set master switch is momentarily placed in OFF/RESET position and then returned to RUN.

Auto Starting

Move the generator set master switch to the AUTO position to allow startup by the automatic transfer switch or remote start/stop switch (connected to controller terminals 3 and 4).

Terminals 3 and 4 connect to a circuit that automatically starts the generator set crank cycle when an external source closes the circuit.

Note: The controller provides up to 30 seconds of programmable cyclic cranking and up to 60 seconds rest with up to 6 cycles. The default setting is 15 seconds cranking and 15 seconds rest for 3 cycles. Make cyclic cranking adjustments using the keypad. See Section 2.9.14, Menu 14—Programming Mode, and Section 2.9.8, Menu 8—Time Delays.

Idle (Speed) Mode Warmup Function

The idle (speed) mode function provides the ability to start and run the engine at reduced speed for a selectable time period (0-10 minutes) during warmup. See Section 6.1.6, Idle (Speed) Mode Feature, for installation information.

To start idle warmup, the master switch must be in the AUTO position. Activate the idle mode input by closing the contacts at the particular auxiliary digital input assigned to Idle Mode (D21 by default). The generator

set will run at idle speed until the engine coolant temperature reaches the pre-programmed warmup temperature, at which point the engine will run at normal speed.

The controller overrides the idle speed function when the generator set is signaled to start via remote start input while in the AUTO position. This override provides emergency generator set power in the event of a utility power failure. When the utility power returns and the generator set is signalled to stop, the generator set continues to run for the duration of the idle mode period when the idle mode is active. When the idle mode is deactivated (by opening contacts), the generator set will shut down in the normal stopping mode including time delays.

See Menu 9—Input Setup to activate the idle speed function as a user-defined digital input. The idle speed feature requires an ECM-equipped engine with the idle speed function.

Run Time Feature

The run time feature allows the user to set up the generator set to run unassisted and automatically return to the standby mode. The user does not need to wait for the exercise period (run time) to conclude in order to place the unit back in the standby mode. See Menu 4—Operational Records for setup of this feature.

With the run time enabled, the generator set will begin to crank and run based on the run time period and all previously established time delays from Menu 8—Time Delays.

Generator Set Connected to an Automatic Transfer Switch. Should a utility power failure occur while the unit is in the run time mode, the controller will bypass the run time mode and function in the standby (backup) mode. When the utility power returns, the generator set continues to run for the duration of the run time period when not timed out.

Note: Press the STOP PROG RUN key, when necessary, to stop the generator set when it is in the run time mode.

Prime Power Switch

The digital controller has an optional prime power mode of operation. The prime power mode requires installation of an optional prime power switch kit. See Section 6, Accessories, for instructions on how to install the optional prime power switch kit. The prime power switch kit prevents engine starting battery drain when the generator set is shut down and no external battery charging is available.

Move the prime power switch located on the back of the controller to the CONTROLLER ON position and set the controller time and date before attempting to start the generator set. When the prime power mode is on, all controller functions including the digital display, LEDs, and alarm horn are operative.

Note: After energizing the controller using the prime power switch, set the controller time and date. See Section 2.9.6, Menu 6—Time and Date.

Stop the generator set using the stopping procedures in Section 2.4.2 before placing the generator set in the prime power off mode. Move the prime power switch located on the back of the controller to the CONTROLLER OFF position. When the generator set is in the prime power off mode, all controller functions including the digital display, LEDs, alarm horn, and communications are inoperative.

2.4.2 Stopping (User Stopping and Fault Shutdown)

Manual Stopping (Master Switch in OFF)

Run the generator set without load for 5 minutes prior to shutdown to ensure adequate engine cooldown.

To manually stop the generator set, simply move the master switch to the OFF/RESET position. The generator set will stop immediately with no cooldown time. Manual cooldown without load is required prior to moving to the OFF/RESET position.

Automatic Stopping (Master Switch in AUTO)

To stop the generator set that was started by activating the remote start input when the master switch is in AUTO, simply deactivate the remote start input by opening the contacts of this input.

The generator set will transition to the Cooldown state. The generator set will run at normal speed until the engine coolant temperature falls below the pre-programmed cooldown threshold or until the programmable cooldown time delay expires, whichever occurs first. If the Cooldown Override parameter is set to TRUE, the coolant temperature will be ignored and the cooldown will continue for the full cooldown delay.

If the remote start input is re-activated during the cooldown cycle, the cooldown will abort and normal generator set operation will resume.

Emergency Stopping

Use the controller emergency stop switch or optional remote emergency stop for immediate shutdown.

The emergency stop switch bypasses the time delay engine cooldown and immediately shuts down the generator set.

Note: Use the emergency stop switch(es) for emergency shutdowns only. Use the generator set master switch for normal shutdowns.

The controller system shutdown lamp lights and the unit shuts down when the local or remote emergency stop switch activates.

Battle Switch/Emergency Mode/Fault Override Switch

The *battle* switch function forces the system to ignore normal fault shutdowns such as low oil pressure and high engine temperature. The battle switch does not override the emergency stop, overspeed, and overfrequency shutdowns. When the battle switch function is enabled the generator set continues to run regardless of shutdown signals where potential engine/alternator damage can occur.

When this input is enabled the yellow warning lamp illuminates and stored warning/shutdown events that are ignored continue to log in Menu 5—Event History.

See Section 2.9.9, Menu 9—Input Setup, for information on how to enable the battle switch feature.

Cooldown Temperature Override Function

This feature provides the ability to bypass (override) the generator set's smart cooldown temperature shutdown and force the generator set to run for the full engine cooldown time delay. Set the Override to YES to override temperature based cooldown.

See Section 2.9.8, Menu 8—Time Delays, for information on how to enable the cooldown temperature override feature.

Idle Cooldown Function

Idle (Speed) Model Cooldown Function. To stop the generator set that was started by activating the idle mode input (master switch in AUTO), simply deactivate the idle mode input by opening the contacts at this input.

Idle Delay Infinite (Idle Delay = 9:99). The generator set will be running at idle speed until the idle input is

de-activated. When the idle mode contacts open, the generator set will immediately shut down.

Idle Delay Not Infinite (Idle Delay = 0-10 minutes).

The generator set will transition to the Cooldown state. The generator set will run at idle speed until the engine coolant temperature falls below the pre-programmed cooldown threshold or until the programmable idle time delay expires, whichever occurs first. If the Cooldown Override parameter is set to TRUE, the coolant temperature will be ignored and the cooldown will continue for the full idle delay.

If the remote start input is re-activated during the cooldown cycle, the cooldown will abort and normal generator set operation will resume.

See Section 6.1.6 Idle (Speed) Mode Feature for further information.

2.4.3 Emergency Stop Switch Resetting

Use the following procedure to reset the generator set after shutdown by a local or remote emergency stop switch. Refer to Section 2.4.7, Controller Reset Procedure, to restart the generator set following a fault shutdown.

1. Place the generator set master switch in the OFF/RESET position.
2. Investigate and correct the cause of the emergency stop.
3. Reset the optional remote emergency stop switch by replacing the glass piece, when equipped. Additional glass rods are available as a service part. Reset the controller emergency stop switch by pulling the switch knob outward.
4. After resetting all faults using the controller reset procedure in Section 2.4.7, toggle the generator set master switch to RUN or AUTO to restart the generator set. The generator set will not crank until the reset procedure completes.

2.4.4 Status Lamps

System Ready. The green lamp illuminates when the generator set master switch is in the AUTO position and the system has no fault conditions.

Not in Auto. The yellow lamp illuminates when the generator set master switch is not in the AUTO position. See Master (Switch) Not in Auto in 2.4.5 System Warning Lamp.

2.4.5 System Warning Lamp

The yellow warning lamp illuminates indicating a fault or status event but does not shut down the generator set under the following conditions. In some cases the alarm horn also sounds. See Section 2.4.7, Controller Reset Procedure, for instructions on resetting a system warning.

When the system warning lamp is on and no message displays, press the Reset Menu and the menu down ↓ key to view messages. When the system warning continues, it may lead to a fault and cause a system shutdown.

Use the Alarm Off keypad switch to silence the alarm horn at the operator's discretion. Place the generator set master switch in the AUTO position before silencing the alarm horn. The alarm horn cannot be silenced unless the master switch is in the AUTO position.

Note: Text shown in *italics* in this manual represents digital display messages.

AC Sensing Loss. The lamp illuminates when the controller does not detect nominal generator set AC output voltage after crank disconnect. The local display shows *AC sensing loss*.

Battery Charger Communication Error. The warning lamp on the controller illuminates yellow and the alarm horn sounds when CAN communication with the battery charger has been lost or there is a CAN address communication error. To correct a CAN address error, verify the address identification in the harness and power cycle the controller. Local display shows *chrg comm error*.

Battery Charger Fault. The lamp illuminates and the alarm horn sounds when the battery charger malfunctions or when there is an issue with the battery such as a connection problem or a dead battery. When the temperature compensation sensor is connected, whether active or inactive, and the temperature rises above 60°C (140°F) or below -20°C (-4°F), the battery charger fault will also be displayed indicating that the battery is unable to take charge due to temperature. Absorption timeout will also cause a failure since the battery was unable to accept the expected charge in the time frame given which indicates a potential battery issue. Local display shows *bat chgr fault*.

Battery Charger Value Error. The lamp illuminates and the alarm horn sounds when a battery charger parameter is not within range. The value number in the fault message determines the parameter type. For example, the fault message, *chgr2 val 12 error*, indicates an out-of-range measurement for equalize voltage on battery charger 2.

Local display shows *chgr1/2 val 1-23 error*. Use the list of fault values, 1-23, below to determine the corresponding parameters.

1. Topology
2. System Volt
3. Auto Equalize
4. Temperature Comp
5. Bulk Volt
6. Absorp_Volt
7. Float_Volt
8. Target Absorp Curr
9. Custom Parameter Enable
10. Manual Equalize Enable
11. Temperature Comp Slope
12. Equalize Voltage
13. Max Absorption Time
14. Max Bulk Time
15. Bulk Return
16. Force Reset
17. Depleted Current Limit
18. Equalize Current Limit
19. Depleted Voltage Target
20. Refresh Time
21. Equalize Duration
22. Cycles Between Auto Equalize
23. Charger Installed

Battle Switch. The lamp illuminates when in the battle switch mode. The local display shows *battle switch*.

Breaker Closed. The lamp illuminates when the respective circuit breaker is closed. The local display shows *breaker closed*. (Paralleling applications only.)

Breaker Trip. The lamp illuminates when the respective circuit breaker is tripped. The local display shows *breaker trip*. (Paralleling applications only.)

Common Protective Relay Output. The lamp illuminates when a common protective relay fault occurs. The local display shows *common pr output*. (Paralleling applications only.)

Customer Auxiliary (Warning). The lamp illuminates and the alarm horn sounds when an auxiliary digital or analog inputs signals the controller. The user can define inputs as shutdowns or warnings. The local display shows digital input *D01-D21* or analog input *A01-A07*.

Using the remote communications package, the user can label the auxiliary functions. The controller displays the selected name instead of digital input *D01-D21* or analog input *A01-A07*.

Defined Common Faults. The lamp illuminates and the alarm horn sounds when one or more of the (user-selected) defined common faults are energized. The local display shows *defined common fault*.

Detonation Warning. The lamp illuminates and the alarm horn sounds when the engine detects combustion system detonation. The local display shows *deton warning*. (Waukesha-powered models only.)

ECM Yellow Alarm. The lamp illuminates and the alarm horn sounds when ECM yellow alarm signals the controller. The local display shows *ECM yellow alarm*. This fault only relates to the DDC/MTU engine with MDEC/ADEC. The user can navigate the menus to access the fault code. The engine operation manual provides the fault code descriptions.

Emergency Power System (EPS) Supplying Load. The lamp illuminates when the generator set supplies more than 1% of the rated standby output current. The local display shows *EPS supplying load*.

Ground Fault Detected. The lamp illuminates and the alarm horn sounds when a user-supplied ground fault detector signals the controller. The local display shows *ground fault*.

High Battery Voltage. The lamp illuminates when the battery voltage rises above the preset level for more than 10 seconds. The local display shows *high battery voltage*. Figure 2-1 shows high battery voltage specifications. The high battery voltage feature monitors the battery and battery charging system in the generator set operating and off modes.

Engine Electrical System Voltage	High Battery Voltage Range	High Battery Voltage Default Setting
12	14.5-16.5	16
24	29-33	32

Figure 2-1 High Battery Voltage Specs

High Coolant Temperature Warning. The lamp illuminates and the alarm horn sounds when the engine coolant temperature approaches the shutdown range. The local display shows *hi cool temp warning*.

High Oil Temperature Warning. The lamp illuminates and the alarm horn sounds when the engine high oil temperature approaches the shutdown range. The local display shows *hi oil temp warning* (DDC/MTU models with MDEC/ADEC and Waukesha-powered models only).

Idle (Speed) Mode. The lamp illuminates when in the idle (speed) mode. The local display shows *idle mode active*. See Section 6.1.6 for idle mode operation.

Intake Air Temperature Warning. The lamp illuminates and the alarm horn sounds when the engine intake air temperature approaches the shutdown range. The local display shows *intake air temp warn* (DDC/MTU models with MDEC/ADEC) and *03 intake air temp warn* (Waukesha-powered models).

Load Shed. The lamp illuminates when the generator set's total kW load exceeds the programmed level for more than the load shed time. When the load shed alarm sounds and resets more than twice in 1 minute, the load shed warning lamp circuit latches and remains on until the generator set shuts down. The local display shows *load shed kW over*.

When the generator set frequency drops to less than 59 Hz on a 60 Hz system or 49 Hz on a 50 Hz system for more than 5 seconds, the local display shows *load shed under freq*. When the load shed alarm sounds and resets more than twice in 1 minute, the load shed warning lamp latches and remains on until the generator set shuts down.

Low Battery Voltage. The lamp illuminates when the battery voltage drops below a preset level for more than 10 seconds. The local display shows *low battery voltage*. See Figure 2-2 for low battery voltage specifications.

Engine Electrical System Voltage	Low Battery Voltage Range	Low Battery Voltage Default Setting
12	10-12.5	12
24	20-25	24

Figure 2-2 Low Battery Voltage Specs

The low battery voltage feature monitors the battery and battery charging system in the generator set operating and off modes. The controller logic inhibits the low battery voltage warning during the crank cycle.

Low Coolant Temperature. The lamp illuminates and the alarm horn sounds when the engine coolant temperature is low. The local display shows *low coolant temp*.

Low Fuel (Level or Pressure) Warning. The lamp illuminates and the alarm horn sounds when the fuel tank level on gasoline or diesel models approaches empty or low fuel pressure on gaseous fueled models occurs. This fault requires an optional low fuel switch for the lamp to function. The local display shows *low fuel warning*.

(Low) Oil Pressure Warning. The lamp illuminates and the alarm horn sounds when the engine oil pressure approaches the shutdown range. The local display shows *oil press warning*.

Master (Switch) Not in Auto. The lamp illuminates and the alarm horn sounds when the generator set master switch is in the RUN or OFF/RESET position. The local display shows *master not in auto*. The Not in Auto lamp will also illuminate.

NFPA 110 Fault. The lamp illuminates and the alarm horn sounds when NFPA 110 faults signal the controller. The local display shows the respective fault message. The NFPA 110 faults (Warning/Shutdown) include:

- Air damper indicator (Factory-Reserved D20) (S)
- Battery charger fault (Factory-Reserved D01) (W)
- EPS supplying load (W)
- High battery voltage (W)
- High coolant temperature (W)
- High coolant temperature (S)
- Low battery voltage (W)
- Low coolant level (Factory-Reserved D14) (S)
- Low coolant temperature (Factory-Reserved D03) (W)
- Low fuel (level or pressure) (Factory-Reserved D02) (W)
- Low oil pressure (W)
- Low oil pressure (S)
- Master switch not in auto (W)
- Overcrank (S)
- Overspeed (S)

No Air Temperature Signal. The lamp illuminates and the alarm horn sounds when the air temperature sender circuit is open. The local display shows *no air temp signal*. (Waukesha-powered models only.)

No Oil Temperature Signal. The lamp illuminates and the alarm horn sounds when the oil temperature sender circuit is open. The local display shows *no oil temp signal*. (Waukesha-powered models only.)

Oil Temperature. The lamp illuminates and the alarm horn sounds when oil temperature approaches the shutdown range. The local display shows *oil temp*. (Waukesha-powered models only.)

Overcurrent. The lamp illuminates and the alarm horn sounds when the generator set supplies more than 110% of the rated standby output current for more than 10 seconds. The local display shows *overcurrent*.

Speed Sensor Fault. The lamp illuminates and the alarm horn sounds when the speed signal is absent for one second while the generator set runs. The local display shows *speed sensor fault*. This warning lamp remains on until the operator places the master switch in the OFF/RESET position.

Turbocharger Temperature Warning. The lamp illuminates and the alarm horn sounds when the ambient air temperature approaches the shutdown range. The local display shows *turbo temp warning* (1750/2000REOZMD models).

Weak Battery. The lamp illuminates when the battery voltage falls below 60% of the nominal voltage (12 VDC or 24 VDC) for more than 2 seconds during the crank cycle. The local display shows *weak battery*.

2.4.6 System Shutdown Lamp

The red lamp illuminates, the alarm horn sounds, and the unit shuts down to indicate a fault shutdown under the following conditions. See Section 2.4.7, Controller Reset Procedure, for information on resetting a system shutdown.

Use the Alarm Off keypad switch to silence the alarm horn at the operator's discretion. Place the generator set master switch in the AUTO position before silencing the alarm horn. The alarm horn will not stop sounding unless the master switch is in the AUTO position.

Note: The text shown in *italics* represents digital display messages.

Air Damper Indicator. The lamp illuminates and the unit shuts down when signaled by a closed air damper circuit. The local display shows *air damper indicator*.

Air/Fuel Module. The lamp illuminates and the unit shuts down when the controller detects a fault with the air/fuel module. The local display shows *afm shutdown*. (Waukesha-powered models only.)

Alternator Protection. The lamp illuminates and the unit shuts down because of an alternator overload or short circuit. The local display shows *altrntr protect sdwn*. See Appendix D, Alternator Protection for more information.

Critical Overvoltage. The lamp illuminates and the unit shuts down when the voltage exceeds 275 volts. The local display shows *critical overvoltage*.

For voltages configurations of **240 volts and less**, the critical voltage shutdown monitors nominal voltage line-to-line. For voltage configurations **greater than 240 volts and less than 600 volts**, the critical voltage shutdown monitors nominal voltage line-to-line with a center tap connection. For voltage configurations of **600 volts and above**, the critical voltage shutdown monitors nominal voltage with a stepdown transformer in the 208–240 voltage range.

Customer Auxiliary (Shutdown). The lamp illuminates and the unit shuts down when an auxiliary digital or analog input signals the controller. The user can define inputs as shutdowns or warnings. The local display shows digital input *D01-D21* or analog input *A01-A07* when activated.

Using the remote communications package, the user can label the auxiliary functions. The controller displays the selected name instead of digital input *D01-D21* or analog input *A01-A07*.

Defined Common Faults. The lamp illuminates and the unit shuts down when one or more of the (user-selected) defined common faults are energized. The local display shows *defined common fault*.

Detonation Shutdown. The lamp illuminates and the unit shuts down when the controller detects combustion system detonation. The local display shows *deton shutdown*. (Waukesha-powered models only.)

ECM Red Alarm. The lamp illuminates and the unit shuts down when the controller receives a signal from the engine. The local display shows *ECM red alarm*. This fault only relates to the DDC/MTU engine with MDEC/ADEC. The user can navigate the menus to access the fault code. The engine operation manual provides the fault code descriptions.

EEPROM Write Failure. The lamp illuminates and the unit shuts down when the control logic detects a data save error. The local display shows *EEPROM write failure*.

(Engine) J1939 CAN Shutdown. The lamp illuminates and the unit shuts down when the control logic detects an engine ECM communication signal interruption. The local display shows *J1939 CAN shutdown*.

Engine Stalled. The lamp illuminates and the unit shuts down when the control logic detects an engine ECM signal that the engine has stalled. The local display shows *engine stalled* and no attempts to restart the engine will occur.

Emergency Stop. The lamp illuminates and the unit shuts down when the local or optional remote emergency stop switch activates. The local display shows *emergency stop*.

Field Overvoltage. The lamp illuminates and the unit shuts down when the controller detects field overvoltage. The local display shows *field over volts*. (350–2000 kW generator sets only)

High Coolant Temperature Shutdown. The lamp illuminates and the unit shuts down because of high engine coolant temperature. The shutdown occurs 5 seconds after the engine reaches the temperature shutdown range. The high engine temperature shutdown does not function during the first 30 seconds after startup. The local display shows *hi cool temp shutdown*.

Note: The high engine temperature shutdown function and the low coolant level shutdown function are independent. A low coolant level condition may not activate the high engine temperature switch.

High Oil Temperature. The lamp illuminates and the unit shuts down because of high engine oil temperature. The shutdown occurs 5 seconds after the engine oil reaches the temperature shutdown range. The high engine oil temperature shutdown does not function during the first 30 seconds after startup. The local display shows *high oil temp sdwn*.

Intake Air Temperature. The lamp illuminates and the unit shuts down because of high intake air temperature. The shutdown occurs 5 seconds after the engine intake air reaches the temperature shutdown range. The engine intake air temperature shutdown does not function during the first 30 seconds after startup. The local display shows *intake air temp shutdown* (DDC/MTU models with MDEC/ADEC) and *03 intake air temp shutdown* (Waukesha-powered models).

Internal Fault. The lamp illuminates and the unit shuts down when the internal diagnostics detect a controller malfunction. The local display shows *internal fault*.

Knock Shutdown. The lamp illuminates and the unit shuts down when the controller detects a detonation fault. The local display shows *knock shutdown*. (Waukesha-powered models only.)

Locked Rotor. If none of the speed sensing inputs show engine rotation within 5 seconds of initiating engine cranking, the ignition and crank circuits turn off for 5 seconds and the cycle repeats. The unit shuts down after the second cycle of 5 seconds of cranking. The local display shows *locked rotor*.

Loss of ECM Communications. The lamp illuminates and the unit shuts down when the ECM communication link is disrupted. The local display shows *loss of ECM comm*.

Loss of Field (Reverse VARs). The lamp illuminates and the unit shuts down when the reactive current into the alternator (absorbing) exceeds the shutdown level. This could be caused by a disruption of the field signal. The local display shows *sd loss of field*. (Paralleling applications only.)

Low Coolant Level. The lamp illuminates and the unit shuts down because of low coolant level. Shutdown occurs 5 seconds after low coolant level is detected. Low coolant level shutdown is inhibited during the first 30 seconds after startup. Local display shows *low coolant lvl*.

Low Coolant Temperature. The lamp illuminates and the unit shuts down because of low coolant temperature. Shutdown occurs 5 seconds after low coolant temperature is detected. Low coolant temperature shutdown is inhibited during the first 30 seconds after startup. Local display shows *low coolant temp shutdown*. (DDC/MTU models with MDEC/ADEC only.)

Low Fuel (Pressure) Shutdown. The lamp illuminates and the unit shuts down when the controller detects a low fuel condition. The low fuel (pressure) shutdown does not function during the first 5 seconds after startup. The local display shows *low fuel shdwn*. (125RZG only.)

(Low) Oil Pressure Shutdown. The lamp illuminates when the unit shuts down because of low oil pressure. The shutdown occurs 5 seconds after the low pressure condition is detected. The low oil pressure shutdown does not function during first the 30 seconds after startup. The local display shows *(low) oil press shutdown*.

Master Switch Error. The lamp illuminates and the unit shuts down when the controller detects a fault in the master switch position or circuit. The local display shows *master switch error*.

Master Switch Open. The lamp illuminates and the unit shuts down when the controller detects an open circuit in the master switch circuit. The local display shows *master switch open*.

Master Switch to Off. The lamp illuminates and the unit shuts down when the master switch is moved to the off position. The local display shows *master switch to off*.

NFPA 110 Fault. The lamp illuminates and the unit shuts down when NFPA 110 faults signal the controller. The local display shows the respective fault message. See Section 2.5, Menu List Summary, Menu 10—Output Setup, for the NFPA 110 list.

No Coolant Temperature Signal. The lamp illuminates and the unit shuts down when the engine coolant temperature sender circuit is open. The local display shows *no cool temp signal*.

No Oil Pressure Signal. The lamp illuminates and the unit shuts down when the engine oil pressure sender circuit is open. The local display shows *no oil press signal*.

Overcrank. The lamp illuminates and cranking stops when the unit does not start within the defined cranking period. The local display shows *overcrank*. See Section 2.4.1, Auto Starting, and Section 1, Specifications and Features, for cyclic crank specifications.

Note: The controller is equipped with an automatic restart function. When speed drops below 13 Hz (390 rpm) while the engine is running, the unit attempts to recrank. The unit then follows the cyclic cranking cycle and, when the engine fails to start, will shut down on an overcrank fault condition.

Over Current VR Shutdown. The lamp illuminates and the unit shuts down when the controller detects an overcurrent fault with voltage restraint. The local display shows *sd over current pr.* (Paralleling applications only.)

Overfrequency. The lamp illuminates and the unit shuts down when the frequency is above the overfrequency setting. The local display shows *overfrequency*. See Figure 2-3.

Overfrequency Setting Range	Time Delay	Overfrequency Default Setting
102%–140% of nominal	10 sec.	110% of nominal

Figure 2-3 Overfrequency Specs

Overpower. The lamp illuminates and the unit shuts down when the controller detects a fault in the paralleling system. The shutdown is set at 102% for standby and 112% for prime power applications. The local display shows *over power*. (Paralleling applications only.)

Overspeed. The lamp illuminates and the unit shuts down immediately when the governed frequency on 50 and 60 Hz models exceeds the overspeed setting for 0.25 seconds. The local display shows *overspeed*. See Figure 2-4 for overspeed specs.

Generator Set Frequency Hz	Time Delay	Overspeed Range Hz	Overspeed Default Setting Hz
60	0.25 sec.	65–70	70
50	0.25 sec.	55–70	70

Figure 2-4 Overspeed Specs

Overvoltage. The lamp illuminates and the unit shuts down when the voltage exceeds the overvoltage setting for the time delay period. The local display shows *overvoltage*. Overvoltage specifications follow. See Figure 2-5.

Note: Overvoltage can damage sensitive equipment in less than one second. Install separate overvoltage protection on online equipment requiring faster than 2-second shutdown.

Overvoltage Setting Range	Time Delay Range	Overvoltage Default Setting without Paralleling	Overvoltage Default Setting with Paralleling
105%–135% of nominal	2–10 sec.	115% at 2 sec.	135% at 10 sec.

Figure 2-5 Overvoltage Specs

Reverse Power. The lamp illuminates and the unit shuts down when the controller detects a reverse power condition. The reverse power relay senses AC power flow into the generator set. If the generator set is being feed power or being "motored" by another generator set or the utility, the reverse power relay senses this AC power flow and opens the generator set circuit breaker. The local display shows *sd reverse power*. (Paralleling applications only.)

Turbocharger Temperature Shutdown. The lamp illuminates and the alarm horn sounds when the ambient air temperature reaches the shutdown range. The local display shows *turbo temp shutdown* (1750/2000REOZMD models).

Underfrequency. The lamp illuminates and the unit shuts down when the frequency falls below the underfrequency setting. The local display shows *underfrequency*. See Figure 2-6.

Underfreq. Setting Range	Time Delay	Underfrequency Default Setting without Paralleling	Underfrequency Default Setting with Paralleling
80%–95% of nominal	10 sec.	90% of nominal	80% of nominal

Figure 2-6 Underfrequency Specs

Undervoltage. The lamp illuminates and the unit shuts down when the voltage falls below the undervoltage setting for the time delay period. The local display shows *undervoltage*. Undervoltage specifications follow. See Figure 2-7.

Undervoltage Setting Range	Time Delay Range	Undervoltage Default Setting w-o/Paralleling	Undervoltage Default Setting w/Paralleling
70%–95% of nominal	5–30 sec.	85% of nominal at 10 sec.	70% of nominal at 30 sec.

Figure 2-7 Undervoltage Specs

2.4.7 Controller Resetting (Following System Shutdown or Warning)

Use the following procedure to restart the generator set after a system shutdown or to clear a warning lamp condition. This procedure includes the resetting of the optional remote annunciator and the audiovisual alarm.

Refer to Section 2.4.3, Emergency Stop Switch Reset Procedure, to reset the generator set after an emergency stop.

1. Move the generator set master switch to the AUTO position, if not already done.
2. Silence the controller alarm horn by pressing the *alarm off* key.

When equipped, the optional remote annunciator and/or audiovisual alarm horn and lamp activate. Move the alarm switch to the SILENCE position to stop the alarm horn. The lamp stays lit.

3. Disconnect the generator set load using the line circuit breaker or automatic transfer switch.
4. Correct the cause of the fault shutdown or warning. See the Safety Precautions and Instructions section of this manual before proceeding.
5. Start the generator set by moving the generator set master switch to the OFF/RESET position and then to the RUN position.

When equipped, the remote annunciator and/or audiovisual alarm horn sounds when the alarm switch is in the NORMAL position. When necessary, move the alarm switch to the SILENCE position to stop the alarm horn. The lamp turns off.

6. Test operate the generator set to verify correction of the shutdown cause.
7. Move the generator set master switch to the OFF/RESET position to stop the generator set.
8. Move the generator set master switch to the AUTO position.
9. Silence the controller alarm horn by pressing the *alarm off* key.
10. Reconnect the generator set load via the line circuit breaker or automatic transfer switch.
11. Move the generator set master switch to the AUTO position for startup by the remote transfer switch or the remote start/stop switch.

When equipped, move the remote annunciator and/or audiovisual alarm switch to the NORMAL position.

2.5 Menu List Summary

Use the Menu List Summary section on the following pages after reading and understanding the features of the keypad. See Section 1.2.2, Digital Display and Keypad.

The Menu List Summary provides a quick reference to the digital display data. Some digital display data may not be identical to your display due to generator set application differences. The closed bullet items represent main level data and the open bullet items are sub-level data.

Section 2.8, Reviewing the Menu Displays, provides a digital display menu overview and explains the navigation using the down and right arrow keys.

Section 2.9, Local Programming Mode On, contains the keystroke details of each menu when programming.

User Inputs. Available user inputs are dependent on factory-reserved inputs for specific engine types, engine controls, and paralleling applications. See Figure 2-8 for analog and digital inputs that are not user-selectable.

Input Type	Specific Applications						
	ECM Engine	Non-ECM Engine	NFPA 110	Waukesha-Powered Engine	with Menu 15 (Paralleling Application)	DDC/MTU Engine with MDEC/ADEC	Other Specialized Application
Analog Inputs							
A1	X	Coolant Temperature *	X	Coolant Temperature *	X	X	X
A2	X	Oil Pressure *	X	Oil Pressure *	X	X	X
A3	X	X	X	Intake Air Temperature *	X	X	X
A4	Fuel Level *	Fuel Level *	Fuel Level *	Oil Temperature Warning *	Fuel Level *	Fuel Level *	Fuel Level *
A5	X	X	X	X	X	X	X
A6	X	X	X	X	X	X	X (8) *
A7 (9)	Voltage Adjust	Voltage Adjust	Voltage Adjust	Voltage Adjust	Voltage Adjust	Voltage Adjust	Voltage Adjust
Digital Inputs							
D1	X	X	Battery Charger Fault *	X	X	X	X
D2	X	X	Low Fuel Warning *	X	X	X	X
D3	Low Coolant Temp.	X	Low Coolant Temp.*	X	X	X	X
D4	X	X	X	X	X	X	X (1) *
D5	X	X	X	X	Breaker Closed *	X	X
D6	X	X	X	X	Enable Synch *	X	X
D7	X	X	X	X	X	X	X
D8	X	X	X	X	X	X	X
D9	X	X	X	X	X	X	X (2) *
D10	X	X	X	X	X	X	X
D11	X	X	X	AFM Shutdown *	X	X	X
D12	X	X	X	Deton Warning *	X	X	X
D13	X	X	X	Deton/Knock Shutdown *	X	X	X
D14	X	X	Low Coolant Level (with LCL Switch) *	X	X	X	X
D15	X	X	X	X	X	X	X (3) *
D16	X	X	X	X	X	X	X (4) *
D17	X	X	X	X	X	X	X (5) *
D18	X	X	X	X	X	X	X (6) *
D19	X	X	X	X	X	X	X (7) *
D20	X	X	Air Damper *	X	X	X	X
D21	Idle Mode Active	X	X	X	X	X	X
<p>(1) D4 is preassigned as Field Overvolts when using a Marathon M4/M5/M7/M10 alternator. (2) D9 is preassigned as Low Fuel Shutdown when using 125RZG (GM powered). (3) D15 is preassigned as Remote Shutdown. (4) D16 is preassigned as Remote Reset. (5) D17 is preassigned as VAR/PF mode. (6) D18 is preassigned as Voltage Lower. (7) D19 is preassigned as Voltage Raise. (8) A6 is available for assignment as Variable Speed Governor (VSG) (Volvo, GM, Doosan, and KDI engines only) (9) A7 is default location, however the default function is not Analog Voltage Adjust; the function must be enabled. See Section 1.3.3. * Factory-reserved inputs that are fixed and not user-changeable.</p>							

Figure 2-8 User Inputs (X) and Factory-Reserved Inputs (as shown)

Menu List Summary (Legend: ● First level submenu, ○ second level submenu)

Menu 1 Generator Monitoring	Menu 2 Engine Monitoring	Menu 2 Engine Monitoring, cont.	Menu 4 Operational Records
<p>Volts & Amps</p> <ul style="list-style-type: none"> ● L1-L2 Volts L1 Amps ● L2-L3 Volts L2 Amps (3 phase) ● L3-L1 Volts L3 Amps (3 phase) ● L1-L2 Volts L2 Amps (1 phase) ● L1-L0 Volts L1 Amps ● L2-L0 Volts L2 Amps ● L3-L0 Volts L3 Amps (3 phase) ● Frequency <p>V & A Summary</p> <ul style="list-style-type: none"> ● V L1-L2, L2-L3, L3-L1 (3 phase) ● V L1-L0, L2-L0, L3-L0 (3 phase) ● A L1, L2, L3 (3 phase) ● V L1-L2, L1-L0, L2-L0 (1 phase) ● A L1, L2 (1 phase) <p>Power kW</p> <ul style="list-style-type: none"> ● Total kW Power Factor ● L1 kW Power Factor ● L2 kW Power Factor ● L3 kW Power Factor (3 phase) ● Total kW % of Rated kW <p>Power kVAR</p> <ul style="list-style-type: none"> ● Total kVAR Absorbing/Generating ● L1 kVAR Absorbing/Generating ● L2 kVAR Absorbing/Generating ● L3 kVAR Absorbing/Generating (3 phase) <p>Power kVA</p> <ul style="list-style-type: none"> ● Total kVA ● L1 kVA ● L2 kVA ● L3 kVA (3 phase) 	<p>Engine Monitoring Basic</p> <ul style="list-style-type: none"> ● Oil Pressure Coolant Temperature ● Intake Air Temperature Oil Temperature (DDC/MTU engine with MDEC/ADEC and Waukesha engine only) ● Engine RPM Local Battery VDC ● High Coolant Temperature Shutdown and Warning Setpoints ● Low Oil Pressure Shutdown and Warning Setpoints ● Engine Warmup Temperature Setpoint ● Engine Cooldown Temperature Setpoint <p>Engine Monitoring Detailed (DDEC/JDEC/EMS2/EDC3 equipped engines only)</p> <p>Engine Fuel</p> <ul style="list-style-type: none"> ● Fuel Pressure Fuel Temperature ● Charge Air Pressure Charge Air Temperature ● Fuel Rate ● Used Last Run <p>Engine Coolant</p> <ul style="list-style-type: none"> ● Coolant Pressure Coolant Temperature ● Coolant Level <p>Engine Oil</p> <ul style="list-style-type: none"> ● Oil Pressure Oil Temperature ● Oil Level Crankcase Pressure <p>Engine Misc</p> <ul style="list-style-type: none"> ● ECM Battery VDC Ambient Temperature ● Engine Model No. ● Engine Serial No. ● Unit No. ECM S/N ● ECM Fault Codes 	<p>Engine Monitoring Detailed (MDEC/ADEC equipped engines only)</p> <p>Engine Fuel</p> <ul style="list-style-type: none"> ● Fuel Pressure Fuel Temperature ● Charge Air Pressure Charge Air Temperature ● Fuel Rate ● Daily Fuel Used ● Total Fuel Used <p>Engine Oil</p> <ul style="list-style-type: none"> ● Oil Pressure Oil Temperature <p>Engine Misc</p> <ul style="list-style-type: none"> ● ECU Supply VDC Ambient Temperature ● ECU Hours ● ECU Fault Codes <hr/> <p>Menu 3 Analog Monitoring</p> <ul style="list-style-type: none"> ● Local Batt VDC ● Analog 01 to 07 (user-defined descriptions) (Scroll through 7 user-defined descriptions. See Figure 2-8 in User Inputs for factory-reserved inputs that are not user-selectable.) <p>Non-ECM Engines</p> <ul style="list-style-type: none"> ● A03-A07 User-Defined <p>ECM Engines</p> <ul style="list-style-type: none"> ● A01 Coolant Temperature ● A02 Oil Pressure ● A03-A07 User-Defined ● A06 VSG (User has option to set to VSG for Doosan, GM, Volvo, and KDI only) <p>Waukesha Engines</p> <ul style="list-style-type: none"> ● A05-A07 User-Defined 	<ul style="list-style-type: none"> ● Factory Test Date ● Total Run Time ● Total Run Time Loaded Hours ● Total Run Time Unloaded Hours ● Total Run Time kW Hours ● No. of Starts ● Engine Start Countdown <ul style="list-style-type: none"> ○ Run Time ● Records-Maintenance <ul style="list-style-type: none"> ○ Reset Records ● Run Time Since Maintenance Total Hours ● Run Time Since Maintenance Loaded Hours ● Run Time Since Maintenance Unloaded Hours ● Run Time Since Maintenance kW Hours ● Operating Days Last Maintenance ● No. of Starts Last Maintenance ● Last Start Date ● Length of Run (Un)loaded Hours <hr/> <p>Menu 5 Event History</p> <ul style="list-style-type: none"> ● (Message Text) ● (Scroll through up to 100 stored events) <hr/> <p>Menu 6 Time and Date</p> <ul style="list-style-type: none"> ● Time 00:00 AM/PM ● Date

Menu List Summary, continued (Legend: ● First level submenu, ○ second level submenu)

Menu 7 Generator System	Menu 9 Input Setup	Menu 9 Input Setup, cont.	Menu 10 Output Setup, cont.
<ul style="list-style-type: none"> ● Operating Mode <ul style="list-style-type: none"> ○ Standby Y/N ○ Prime Power N/Y ● System Voltage Line-Line ● System Frequency ● Phase <ul style="list-style-type: none"> ○ 3-Phase Delta Y/N ○ 3-Phase WYE N/Y ○ 1-Phase N/Y ● kW Rating ● Rated Current ● Load Shed Output <ul style="list-style-type: none"> ○ Time Delay ● Overvoltage <ul style="list-style-type: none"> ○ Time Delay ● Undervoltage <ul style="list-style-type: none"> ○ Time Delay ● Overfrequency ● Underfrequency ● Overspeed ● Battery Voltage <ul style="list-style-type: none"> ○ 12 VDC Y/N ○ 24 VDC N/Y ● Low Battery Voltage ● High Battery Voltage ● Block Heater ON † ● Block Heater OFF † ● Enable VSG Y/N † ● Enable DSC † ● Adjust System Speed** ● Speed Adjust Select** ● Metric Units Y/N ● Set NFPA110 Defaults Y/N <p>† DDC/MTU engine w/MDEC/ADEC only **Doosan, GM, Volvo, KDI only</p>	<p>Setup Digital Auxiliary Inputs</p> <ul style="list-style-type: none"> ● Digital Input (Scroll through up to 21 user-defined descriptions. See Figure 2-8 in User Inputs for factory-reserved inputs that are not user-selectable.) ● Digital Input Message Text Y/N, see Group A <p>Group A Preprogrammed selections include the following:</p> <p>Warning</p> <p>Shutdown Type A</p> <p>Shutdown Type B</p> <p>Voltage Raise</p> <p>Voltage Lower</p> <p>VAR PF Mode</p> <p>Remote Shutdown</p> <p>Remote Reset</p> <p>Air Damper</p> <p>Low Fuel</p> <p>Field Overvoltage</p> <p>Idle Mode Active (ECM engines only)</p> <p>Battle Switch</p> <p>Ground Fault</p> <p>Bat Chgr Fault</p> <p>High Oil Temperature (non-ECM only)</p> <p>Low Coolant Level</p> <p>Low Coolant Temperature (Not user-selectable)</p> <p>Breaker Closed, (Paralleling non-selectable)</p> <p>Enable Synchronizer, (Paralleling non-selectable)</p> <p>Air/Fuel Module Shutdown*</p> <p>Knock Shutdown*</p> <p>Detonation Warning*</p> <p>Detonation Shutdown*</p> <p>Low Fuel Shutdown</p> <ul style="list-style-type: none"> ● Digital Input Enable Y/N ● Digital Input Inhibit Time ● Digital Input Delay Time <p>*Waukesha engine only</p>	<p>Setup Analog Auxiliary Inputs</p> <ul style="list-style-type: none"> ● Analog Input (Scroll through up to 7 user-defined descriptions. See Figure 2-8 in User Inputs for factory-reserved inputs that are not user-selectable.) ● Analog Input Warning Enabled Y/N ● Analog Input Shutdown Enabled Y/N ● Analog Input Inhibit Time 0–60 Sec. ● Analog Input Warning Delay Time 0–60 Sec. ● Analog Input Shutdown Delay Time 0–60 Sec. ● Analog Input Low Shutdown Value ● Analog Input Low Warning Value ● Analog Input High Warning Value ● Analog Input High Shutdown Value 	<p>Relay Driver Outputs (RDOs)</p> <ul style="list-style-type: none"> ● RDOs (Y/N) (Scroll through up to 31 status and fault choices from: <ul style="list-style-type: none"> ○ System events, see Group B ○ 21 digital inputs D01-D21 ○ 7 analog inputs A01–A07 <p>Group B System events include the following:</p> <p>Emergency Stop</p> <p>Over Speed</p> <p>Overcrank</p> <p>High Cool Temp Shutdown</p> <p>Oil Pressure Shutdown</p> <p>Low Coolant Temperature (non-ECM engines)</p> <p>Low Fuel Warning</p> <p>Hi Cool Temp Warning</p> <p>Oil Pressure Warning</p> <p>Master Not in Auto</p> <p>NFPA 110 Fault†</p> <p>†The 15 NFPA 110 Common Fault Alarms include the following:</p> <p>Over Speed</p> <p>Overcrank</p> <p>High Coolant Temperature Shutdown</p> <p>Oil Pressure Shutdown</p> <p>Low Coolant Temperature</p> <p>High Coolant Temperature Warning</p> <p>Oil Pressure Warning</p> <p>Low Fuel</p> <p>Master Not In Auto</p> <p>Battery Charger Fault</p> <p>Low Battery Voltage</p> <p>High Battery Voltage</p> <p>Low Coolant Level</p> <p>EPS Supplying Load</p> <p>Air Damper Indicator</p>
<p>Menu 8 Time Delays</p> <ul style="list-style-type: none"> ● Time Delay Engine Start ● Time Delay Starting Aid ● Time Delay Crank On ● Time Delay Crank Pause ● Time Delay Eng. Cooldown ● Cooldown Temperature Override Y/N ● Overcrank Shutdown Crank Cycles ● Time Delay Overvoltage ● Time Delay Undervoltage ● Time Delay Load Shed kW 	<p>Menu 10 Output Setup</p> <p>Defined Common Fault</p> <ul style="list-style-type: none"> ● Defined Common Fault (Y/N for a <i>single</i> defined common fault) Scroll through status and fault choices from: <ul style="list-style-type: none"> ○ System events, see Group B (except Defined Common Fault) ○ 21 digital inputs D01-D21 ○ 7 analog inputs A01–A07 		

Menu List Summary, continued (Legend: ● First level submenu, ○ second level submenu)

Menu 10 Output Setup, cont.	Menu 10 Output Setup, cont.	Menu 11 Voltage Regulator	Menu 12 Calibration
<p>Group B, continued Low Battery Voltage High Battery Voltage Battery Charger Fault System Ready Loss of ECM Comm (ECM engines) No Oil Pressure Signal High Oil Temperature Shutdown No Temperature Signal Low Coolant Level Speed Sensor Fault Locked Rotor Master Switch Error Master Switch Open Master Switch to Off AC Sensing Loss Over Voltage Under Voltage Weak Battery Over Frequency Under Frequency Load Shed kW Over Load Shed Under Freq Over Current EPS Supplying Load Internal Fault Delay Engine Cooldown Delay Engine Start Starting Aid Generator Set Running Air Damper Control Ground Fault EEPROM Write Failure Critical Overvoltage Alternator Protection Air Damper Indicator Defined Common Fault (RDO only) SCRDOs 1-4 (Software-Controlled RDOs)</p>	<p>Group B, continued Reverse Power Shutdown† Over Power Shutdown† Loss of Field Shutdown† Overcurrent VR Shutdown† Common Protective Relay Output† In Synchronization† Breaker Trip† Fuel Valve Relay* Prelube Relay* Air/Fuel Module Remote Start* No Oil Temperature Signal* High Oil Temperature Warning*‡ No Air Temperature Signal* Intake Air Temperature Warning*‡ Intake Air Temperature Shutdown*‡ Air/Fuel Module Engine Start Delay* ECM Yellow Alarm‡ ECM Red Alarm‡ Block Heater Control‡ Low Coolant Temperature Shutdown‡ Load Shed Overtemperature‡ Maintenance Due Engine Derate Active Turbo Temperature Warning§ Turbo Temperature Shutdown§ Engine Stalled (ECM engines) J1939 CAN Shutdown (ECM engines) *Waukesha engine †Paralleling applications ‡DDC/MTU engine with MDEC/ADEC §1750/2000REOZMD</p>	<p>AVG L-L V Volt ADJ ● L1-L2 Volts ● L2-L3 Volts (3 phase) ● L3-L1 Volts (3 phase) Under Freq. Unload Enabled N/Y ● Frequency Setpoint (Cut-In Point) ● Slope Volts-Per-Cycle Reactive Droop Enabled N/Y ● Voltage Droop at 0.8 PF Rated Load VAR Control Enabled N/Y ● Total kVAR (Running) kVAR Adj ● Generating/Absorbing Y/N PF Control Enabled N/Y ● Average PF PF Adjustment ● Lagging/Leading Y/N Regulator Gain Adj. ● Gain Utility Gain Adj. ● Gain Analog Voltage Adjust Enabled N/Y Reset Regulator Defaults?</p>	<p>Scale AC Analog Inputs Generator Set Voltage LN ● Gen L1-L0 V Calibration Reference ● Gen L2-L0 V Calibration Reference ● Gen L3-L0 V (3 phase) Calibration Reference Generator Set Voltage LL ● Gen L1-L2 V Calibration Reference ● Gen L2-L3 V (3 phase) Calibration Reference ● Gen L3-L1 V (3 phase) Calibration Reference ● Calibrate Regulator Y/N Generator Set Amps ● Gen L1 Amps Calibration Reference ● Gen L2 Amps Calibration Reference ● Gen L3 Amps (3 phase) Calibration Reference Load Voltage LN (Paralleling Applications only) ● Load L1-L0 V Calibration Reference ● Load L3-L0 V Calibration Reference Restore Defaults? Y/N Scale Aux. Analog Inputs ● Zero Aux. Analog Inputs? (Scroll through up to 7 user-defined descriptions. See Figure 2-8 in User Inputs for factory-reserved inputs that are not user-selectable.) ● Analog 01 Scale Value 1 ○ Scale 1 V Scale 2 V ● Analog 01 Scale Value 2 ○ Scale 1 V Scale 2 V</p>

Menu List Summary, continued (Legend: ● First level submenu, ○ second level submenu)

Menu 13 Communications	Menu 14 Programming Mode	Menu 18 (v. 3.4.3) Battery Chargers	Menu 18 (v. 3.4.3) Battery Chargers Cont.
<p>Protocol KBUS</p> <ul style="list-style-type: none"> ● KBUS Online Y/N ● Connection Type (User-defined) <ul style="list-style-type: none"> ○ Local Single Y/N ○ Local LAN Y/N ○ Local LAN Conv Y/N ○ Remote Single Y/N ○ Remote LAN Y/N ○ Remote LAN Conv Y/N ● Primary Port (User-defined) <ul style="list-style-type: none"> ○ RS-232 Y/N ○ RS-485 ISO1 Y/N ● Address (LAN Connections) ● System ID (Remote Connections) ● BAUD Rate (User-defined) <ul style="list-style-type: none"> ○ BAUD Rate 1200 ○ BAUD Rate 2400 ○ BAUD Rate 9600 <p>Protocol Modbus 0</p> <ul style="list-style-type: none"> ● Modbus Online N/Y ● Connection Type (User-defined) <ul style="list-style-type: none"> ○ Single Y/N ○ Convertor Y/N ● Primary Port <ul style="list-style-type: none"> ○ RS-485 ○ RS-232 ● Address ● BAUD Rate (User-defined) <ul style="list-style-type: none"> ○ 9600 ○ 19200 <p>Modbus 1</p> <ul style="list-style-type: none"> ● Modbus Online N/Y ● Connection Type (User-defined) <ul style="list-style-type: none"> ○ Single Y/N ○ Convertor Y/N ● Primary Port <ul style="list-style-type: none"> ○ RS-485 ISO ● Address ● BAUD Rate (User-defined) <ul style="list-style-type: none"> ○ 9600 ○ 19200 	<ul style="list-style-type: none"> ● Programming Mode <ul style="list-style-type: none"> ○ Local? Y/N ○ Remote? Y/N ○ Off? Y/N ● Programming Mode Change, Access Code <ul style="list-style-type: none"> ○ Enter Old Code ○ Enter New Code <hr/> <p>Menu 15 Paralleling Relays (PR)</p> <p>Purchased Option</p> <ul style="list-style-type: none"> ● PR Overvoltage VAC <ul style="list-style-type: none"> ○ Time Delay Seconds ● PR Undervoltage VAC <ul style="list-style-type: none"> ○ Time Delay Seconds ● PR Overfrequency Hz <ul style="list-style-type: none"> ○ Time Delay Seconds ● PR Underfrequency Hz <ul style="list-style-type: none"> ○ Time Delay Seconds ● PR Reverse Power kW <ul style="list-style-type: none"> ○ Time Delay Seconds ● SD Reverse Power kW <ul style="list-style-type: none"> ○ Time Delay Seconds ● PR Over Power kW <ul style="list-style-type: none"> ○ Time Delay Seconds ● SD Over Power kW <ul style="list-style-type: none"> ○ Time Delay Seconds ● PR Loss of Field kVAR <ul style="list-style-type: none"> ○ Time Delay Seconds ● SD Loss of Field kVAR <ul style="list-style-type: none"> ○ Time Delay Seconds ● PR Overcurrent Amps <ul style="list-style-type: none"> ○ Time Delay Seconds ● SD Overcurrent Amps <ul style="list-style-type: none"> ○ Time Delay Seconds ● Synchronization <ul style="list-style-type: none"> ○ Synch Voltage Match VAC ○ Synch Freq. Match Hz ○ Synch Phase Match Degrees ○ Time Delay Seconds 	<p>Battery Charger 1</p> <ul style="list-style-type: none"> ● Battery Charger Metering <ul style="list-style-type: none"> ○ Output Voltage ○ Output Current ○ Charger State ○ SFWR Ver (software version) ○ Reduced Output ○ Temp Comp Active ● Battery Charger Basic Config <ul style="list-style-type: none"> ○ Battery Topology ○ Charger System Voltage ○ Automatic Equalize Enabled ○ Temp Compensation Enabled ○ Absorption Termination ● Battery Charger Advanced Config <ul style="list-style-type: none"> ○ Custom Charging Profile Enable ○ Bulk Voltage ○ Absorption Voltage ○ Float Voltage ○ Manual Equalize Active ○ Temperature Comp Slope ○ Equalize Voltage ○ Max Absorption Time ○ Max Bulk Time ○ Bulk State Return Voltage <p>Battery Charger 2</p> <ul style="list-style-type: none"> ● Battery Charger Metering <ul style="list-style-type: none"> ○ Output Voltage ○ Output Current ○ Charger State ○ SFWR Ver (software version) ○ Reduced Output ○ Temp Comp Active ● Battery Charger Basic Config <ul style="list-style-type: none"> ○ Battery Topology ○ Charger System Voltage ○ Automatic Equalize Enabled ○ Temp Compensation Enabled ○ Absorption Termination 	<ul style="list-style-type: none"> ● Battery Charger Advanced Config <ul style="list-style-type: none"> ○ Custom Charging Profile Enable ○ Bulk Voltage ○ Absorption Voltage ○ Float Voltage ○ Manual Equalize Active ○ Temperature Comp Slope ○ Equalize Voltage ○ Max Absorption Time ○ Max Bulk Time ○ Bulk State Return Voltage <hr/> <p>Menu 20 Factory Setup Menu</p> <ul style="list-style-type: none"> ● Final Assembly Date DD/MM/YY ● Final Assembly Clock No. ● Operating Days ● Model No. ● Spec No. ● Generator Set Serial No. ● Alternator Part No. ● Engine Part No. ● Temp Sensor <ul style="list-style-type: none"> ○ GM31045-X ○ GM16787 ○ GM17362 ● Disable Low Coolant Temp Warning (ECM Engines Only) ● Serial No. Confirm <ul style="list-style-type: none"> ○ Confirm Serial? ● Controller Serial No. ● Code Version ● Setup Locked ● Engine Type (Non-ECM Engines Only) <hr/> <p>Menu 55 Load Factor</p> <ul style="list-style-type: none"> ● 100%–125% Load Factor Hours ● 126%–150% Load Factor Hours ● 151%–200% Load Factor Hours ● 201%+ Load Factor Hours

2.6 Reviewing Digital Display

The user interacts with the controller with a keypad and digital display. Use the keypad to access the generator set informational data and preset settings. This review section shows how to access the data. See Section 2.9, Local Programming Mode On, for instructions on how to change the information. See Figure 2-9 for an illustration of the digital display and keypad.

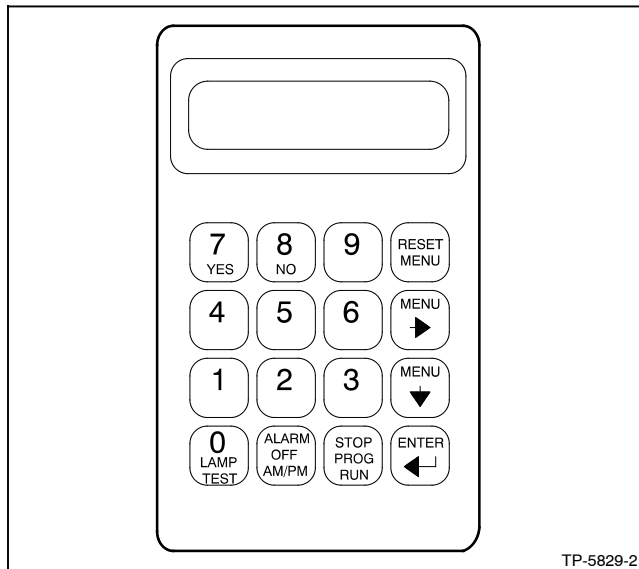

Figure 2-9 Digital Display and Keypad

Note: After energizing the controller by reconnecting the battery, set the controller time and date. See Section 2.9.6, Local Programming Mode On, Menu 6—Time and Date.

Pressing any key on the keypad activates the controller panel display. The panel lamps and display turn off 5 minutes after the last keypad entry.

2.6.1 Keypad Operation

Use the keypad to enter information into the controller. Some of the keys have two functions. The following gives keypad definitions and functions.

Alarm (Horn) Off Key. Press the *alarm off* key to silence the horn at the user's discretion. Place the generator set master switch in the AUTO position before silencing the alarm horn. The alarm horn cannot be silenced unless the master switch is in the AUTO position. See Section 2.4.7, Controller Reset Procedure, for more information on turning the alarm horn off.

AM/PM Key. When the controller displays a question during programming requiring a nonnumeric answer (am or pm), the controller accepts the secondary key function and ignores the *alarm off* function of the key.

Enter ↵ Key. Press the enter ↵ key to confirm the entered information on the display when selecting menus or programming.

Lamp Test Key. Press the lamp test key to check that the status and fault lamps illuminate, the horn sounds, and the digital display clears. Press the reset menu key before pressing the lamp test key.

Menu Down ↓ Key. The controller displays consist of menus with various data levels or programming steps. Use the menu down ↓ key to navigate through the menu levels.

Note: Pressing the menu down ↓ key in some menus locks the user into that level structure of the menu where the display will not change. Press the reset menu key to access other main menus.

Menu Right → Key. Press the menu right → key to scroll through sub-levels of each main menu. The display contains an arrow in the right-hand corner when there is a sub-level. Pressing the menu right → key when no arrow is present moves to the next submenu header. Press the menu right → key prior to entering decimal values when required.

Note: Pressing the menu right → key in some menus locks the user into that level structure of the menu where the display will not change. Press the reset menu key to access other main menus.

Numeric 0-9 Keys. Press the numeric keys when selecting menus or entering numeric values during programming. The controller ignores the secondary function of the key (yes, no, etc.) when only numeric values are valid.

Reset Menu Key. The reset menu key exits a menu, clears incorrect entries, and cancels the auto-scroll function. Press the reset menu key to exit a menu or any layer within that menu.

Stop Prog Run Key. Press the stop prog run key to end the generator set programmed exercise run created in Menu 4—Operational Records. The generator set shuts down after the time delay for engine cooldown expires. The stop prog run key does not affect the programmed transfer switch exercise function.

Yes/No Keys. When the controller displays a question during programming requiring a nonnumeric answer (yes or no), the controller accepts the secondary key function and ignores the numeric value of the key. Press the ENTER key to confirm the response.

2.6.2 Auto-Scroll Function

The auto-scroll function continuously shows voltage and current data from Menu 1—Generator Monitoring, V & A Summary without the need to press the down arrow for each display.

For auto-scroll function press ENTER at the V & A Summary menu. Press the Reset Menu key or Menu Right → key to stop the auto-scroll function.

2.6.3 Request and Error Messages

Note: When EEPROM errors occur or initializing the EEPROM is required, contact an authorized distributor/dealer.

Request and Status Messages

Display messages require the user to enter additional data, confirm the previous entry or require time to process as described below.

Entry Accepted appears for several seconds after pressing the Enter key during the programming mode. The display then shows the new data.

Initialize EEPROM? Prompt to confirm EEPROM initialization.

Reset Complete indicates the user has successfully:

- Reset the maintenance records or
- Restored the AC analog inputs to the default settings.
- Restored voltage regulator settings to the defaults.

Right Arrow → directs the user to the next menu. The menus loop; press the right arrow key to move to the next menu.

Setup Complete indicates the completion of the analog input setup.

Setup Locked appears when user attempts to change a value or perform a function available only when the system is unlocked.

Setup Unlocked appears when user has unlocked the system for maintenance or troubleshooting.

(Question) ? asked by the control firmware; answer the question by pressing the yes/no, numeric digit, or am/pm key.

Wait for System Reset (6 Sec) appears while the EEPROM initializes.

Error Messages

When an error message appears, the entered information is not within the allowable parameters set by the control firmware or is not permitted as described below. In cases where the data was outside the parameters, press the Reset Menu key and enter the corrected information.

Access Denied appears when the user attempts to:

- Enter data prohibited by the master switch position,
- Enter data prohibited by the generator set state, or
- Enable the LDD (load disturbance detection).

Access Denied Idle Mode Active appears when the user attempts to modify the voltage regulator setup while the idle mode is active.

Alarm Active appears when the user attempts to modify an analog or a digital input that is active. See Menu 9—Input Setup.

Cannot Change (because the) NFPA is Enabled appears when the user attempts to modify an RDO setting that is a NFPA 110 default requirement.

Cannot Change Preset appears when the user attempts to change the factory preset analog input, digital input, or input parameter.

EEPROM Write Error appears when a component failure occurs. Contact an authorized distributor/dealer.

Entry Unacceptable appears when the user attempts an invalid input to the voltage regulator setup.

Some alternators are intended to operate within a specific, limited range of conditions (voltage, frequency, and phase or connection). The following error messages can appear when attempts are made to enter system values that do not match acceptable conditions for the particular alternator.

- **Fixed Frequency** when entry is beyond the range of limited entries for the respective alternator. Occurs when the alternator is not rated for the value entered. Updated parameter files may be available by contacting an authorized service dealer/distributor.
- **Fixed Phase** when entry is beyond the range of limited entries for the respective alternator. Occurs when the alternator is not rated for the value entered. Updated parameter files may be available by contacting an authorized service dealer/distributor.

- **Fixed Voltage** when entry is beyond the range of limited entries for the respective alternator. Occurs when the alternator is not rated for the value entered. Updated parameter files may be available by contacting an authorized service dealer/distributor.

Func (Function) Used by (RDO) XX Reassign? appears when the user attempts to assign an RDO to a function already assigned.

Internal Error appears when controller logic detects a functional sequence error.

Invalid Code appears when the user attempts to enter:

- An invalid access code for programming mode setup, or
- An invalid access code for setup unlock.

Invalid Menu ID appears when the user attempts to enter a menu number that is unavailable or non-functional.

N/A appears when data to be displayed is not available.

No Input Assigned appears when the user attempts to assign any of the following system faults to an RDO where the digital input is not defined. See digital input scale requirements in Menu 12—Calibration.

- Air damper indicator
- Battery charger fault
- Ground fault
- High oil temperature shutdown
- Low coolant level
- Low fuel

Not in Local Program Mode appears when the user attempts to program using the keypad when the programming mode is set for remote or off.

Not User-Selectable appears when the user attempts to change an analog or digital input that is factory-reserved. Items identified as *not user-selectable* are included for specific applications. (Example: AFM SHUTDOWN is enabled with a Waukesha-powered model.) The user cannot disable an analog or digital input when identified as not user-selectable. See **Figure 2-8** in User Inputs for factory-reserved digital and analog inputs that are not user-selectable.

Output in Use appears when the user attempts to modify or reassign an active RDO.

Port in Use appears when the user attempts to use an already assigned communications port.

Range Error appears when the user attempts to enter:

- A numeric input that is not within the acceptable range of the system settings, time delays, addresses, etc.
- An invalid analog or digital input number.
- An invalid date/time.

Remove Load appears when trying to calibrate the voltage regulator in menu 12 with load connection. The voltage regulation calibration must be performed during a no load condition.

Setpoint Values Cannot be Equal appears when the user attempts to enter the same value for both setpoints during the analog input calibration.

2.7 Monitoring and Programming Setup

The user can access the controller data with the controller keypad and display or a personal computer (PC) with optional software to monitor and/or program. Access the controller system with a PC using local (direct) or remote (modem) systems. Refer to the Introduction, List of Related Materials for related software literature. See Menu 13—Communications.

The user can access the controller data while in the programming mode off or programming mode on. See Menu 14—Programming Mode.

While this manual focuses on data access and programming through the controller keypad and display, some data entries require input using a PC for initial setup. The PC entries typically include alpha characters such as digital input descriptions. The individual menus in Section 2.9, Local Programming Mode On, indicate where data requires entry using a PC.

There are six basic configurations for data monitoring and programming using access source options. See Figure 2-13.

Other combinations of data monitoring and programming are possible but require programming from a single location. Figure 2-13, Monitoring and Programming Configurations, briefly describes the settings of Menu 13—Communications and Menu 14—Programming Mode based on user-selected operating mode.

Use the keypad and digital display to setup the access configurations the first time. Go to Section 2.9, Local Programming Mode On, and set the desired selection in Menu 13—Communication and Menu 14—Programming Mode before accessing data.

2.7.1 PC Communications

There are four ways to communicate between a PC and the generator set and/or transfer switch devices using KBUS communication protocol. The PC connections require optional software and possibly other hardware, communication modules in the generator set controller and/or transfer switch. See the monitor software operation manual for details. Contact your authorized distributor/dealer for availability.

Local Single Connection

A PC connects to the COM port of the controller module using an RS-232 cable when the PC is within 15 m (50 ft.) of the device or an RS-485 cable when the PC is within 1220 m (4000 ft.) of the device. See Figure 2-10 or Figure 2-11.

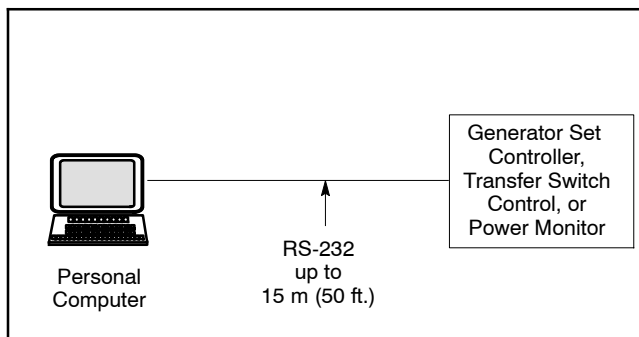

Figure 2-10 Local Single Connection, up to 15 m (50 ft.)

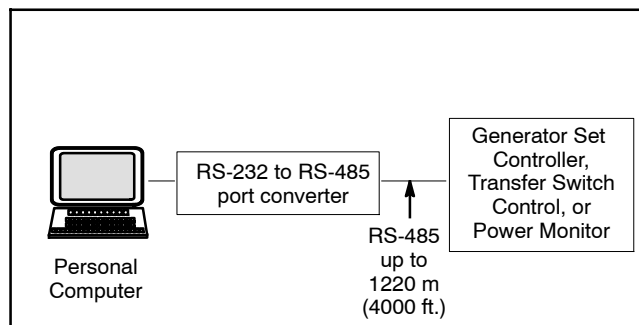

Figure 2-11 Local Single Connection, up to 1220 m (4000 ft.)

Local Area Network (LAN)

A PC connects to the device's LAN. A LAN is a system that connects more than one device to a single PC. Acceptable devices include the Decision-Maker® 550 controller, Decision-Maker® 340 controller, M340 transfer switch control, M340+ transfer switch control, and PM340 power monitor. See Figure 2-12.

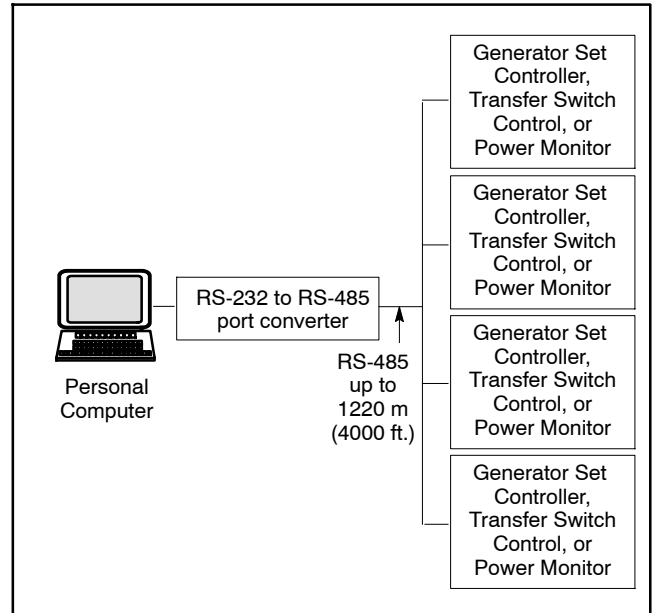

Figure 2-12 Local Area Network

The 550 controller can be used as an RS-232 to RS-485 port converter in a LAN network if the 550 controller is located within 15 m (50 ft.) of the PC. This configuration is the Local LAN Conv option.

User Operating Mode Selection		Menu 13—Communications Settings			Menu 14—Programming Mode		
User Activity	Access Source	On Line?	Local LAN?	Remote Single or LAN?	Programming Mode Off?	Local Programming Mode?	Remote Programming Mode?
Monitor only	Controller	No	No	No	Yes	No	No
	Direct PC	Yes	Yes	No	Yes	No	No
	PC via Telephone Lines	Yes	No	Yes	Yes	No	No
Monitor and Program	Controller	No	No	No	No	Yes	No
	Direct PC	Yes	Yes	No	No	No	Yes
	PC via Telephone Lines	Yes	No	Yes	No	No	Yes

Figure 2-13 Monitoring and Programming Configurations

Remote Single Connection

A modem connects a PC to a single device. The PC communicates with the device via a telephone network. Locate the PC anywhere a telephone line is available. See Figure 2-14.

Remote Area Network

A PC connects to a modem. The devices connect to a LAN network. The PC communicates to the devices via a telephone network that is interfaced to the LAN

network. Acceptable devices include the Decision-Maker® 550 controller, Decision-Maker® 340 controller, M340 transfer switch control, M340+ transfer switch control, and PM340 power monitor. Locate the PC anywhere a telephone line is available. See Figure 2-15.

The 550 controller can be used as an RS-232 to RS-485 port converter in a LAN network if the 550 controller is located within 15 m (50 ft.) of the device modem. This configuration is the Remote LAN Conv option.

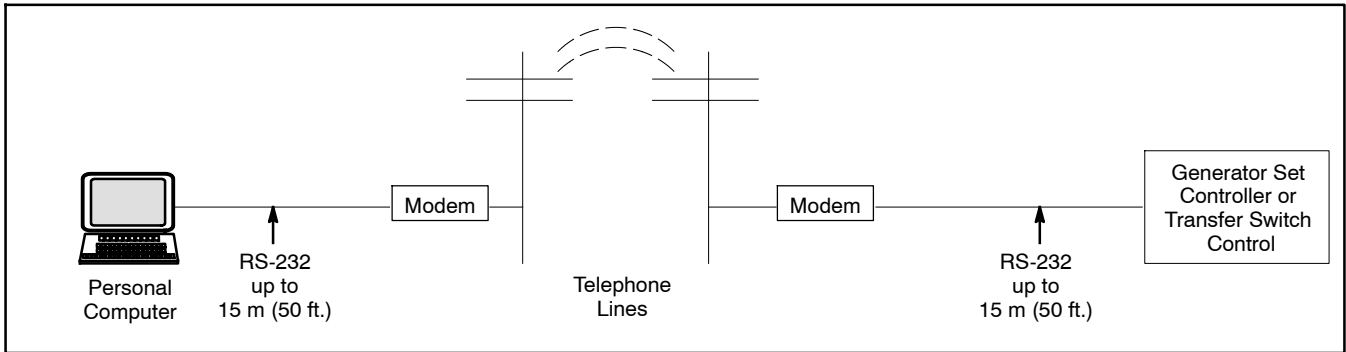

Figure 2-14 Remote Single Connection

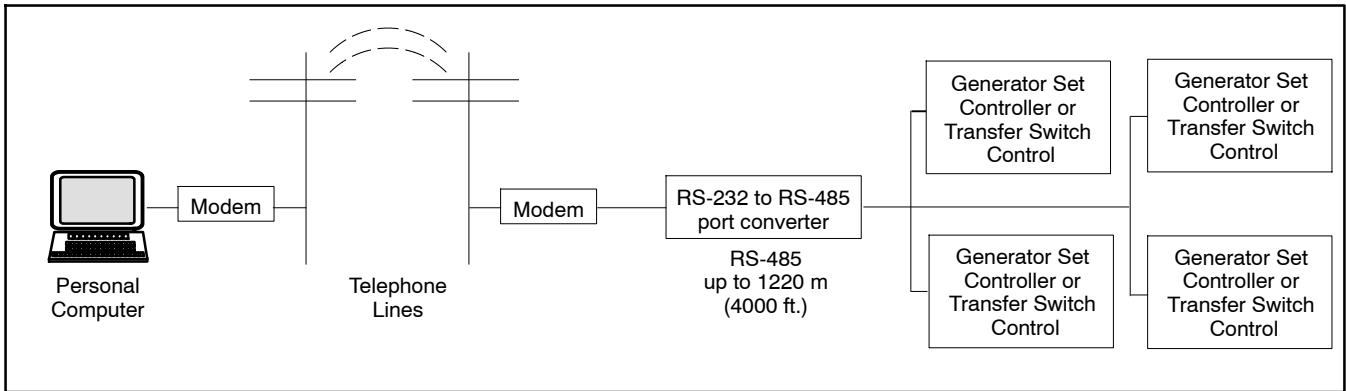

Figure 2-15 Remote Area Network

2.7.2 Modbus Communications

The controller communicates using Modbus® as a slave connection with the Modbus® master initiating the communication. The controller seeks the system and alternator parameters and diagnostic information then responds back to the Modbus® master. In addition, the controller accepts information to alter controller parameters including generator set starting and stopping. See Figure 2-16. Refer to the List of Related Materials for available Modbus® literature.

Note: Only one Modbus® master can be connected to each Modbus port on the 550 controller. Examples include the remote serial annunciator, Monitor III, and switchgear applications.

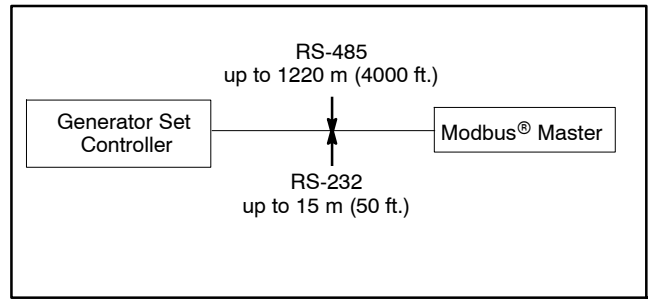

Figure 2-16 Modbus® Connections

2.8 Reviewing Menu Displays

Use this section to review a summary of the generator set controller data. See Figure 2-17 for which menus provide data monitoring and adjusting data.

Press the Reset key, enter the desired menu number key(s), and then press the Enter key. Use the down arrow and right arrow keys for navigation.

See Section 1, Specifications and Features, to review set point ranges and default settings for comparison to the actual setup.

The user must enable the programming mode to edit the display. See Menu 14—Programming Mode and Section 2.9, Local Programming Mode On, for more information.

Note: Press any key on the keypad to activate the controller panel display. The panel display turns off 5 minutes after the last keypad entry.

Note: Press the Reset Menu key to clear error messages.

Note: Press the Menu Right → key prior to entering decimal values where necessary.

Menus displaying the # symbol represent one of the following data types:

- System-calculated data
- System-measured data
- User-entered data

Menus displaying the ? symbol require the user to enter data.

Menus displaying the * symbol represent access code or password type entries. The actual key entry does not display.

See Section 2.6.3, Request and Error Messages, for error display messages and explanations while navigating the menus.

Legend:

▼ Menu Down Key

➤ Menu Right Key

Menu Number	Menu Name	View Only Data	View and Adjust Data
1	Generator Monitoring	X	
2	Engine Monitoring	X	
3	Analog Monitoring	X	
4	Operational Records		X
5	Event History	X	
6	Time and Date		X
7	Generator System		X
8	Time Delays		X
9	Input Setup		X
10	Output Setup		X
11	Voltage Regulator		X
12	Calibration		X
13	Communications		X
14	Programming Mode		X
15	Protective Relays		X
18	Battery Chargers		X
20	Factory Setup		X

Figure 2-17 Menu Displays for Viewing and Adjusting

2.8.1 Menu 1—Generator Monitoring

Menu 1 displays generator output data including line-to-line and line-to-neutral voltages, current, frequency, power factor, total kilowatts, percent of maximum kW, total kVA, and total kVAR. Menu 1 displays three-phase voltage and current readings when applicable.

All menu displays apply to both single-phase and three-phase voltages unless otherwise noted as (1 PH) or (3 PH) on the menu overview. The phase designation does not appear in the controller menu displays.

Note: For the auto-scroll function, press ENTER at V & A Summary menu. Press the Reset Menu key or Menu Right → key to stop the auto-scroll function.

Note: Pressing a right arrow key from any submenu moves to the next submenu header.

Menu 1 Overview (Three-Phase Connections)

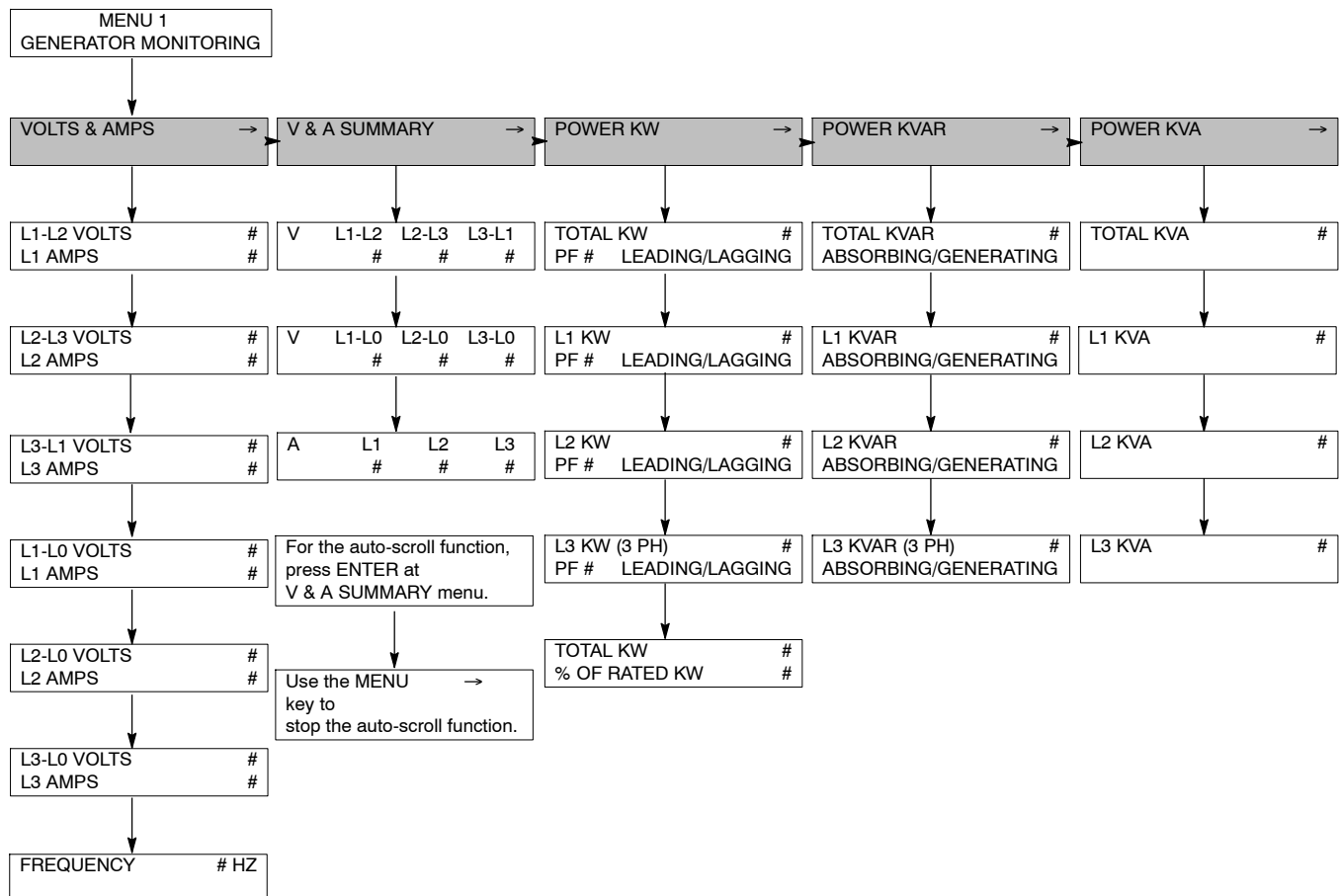

Menu 1—Generator Monitoring, continued

Menu 1 Overview (Single-Phase Connections)

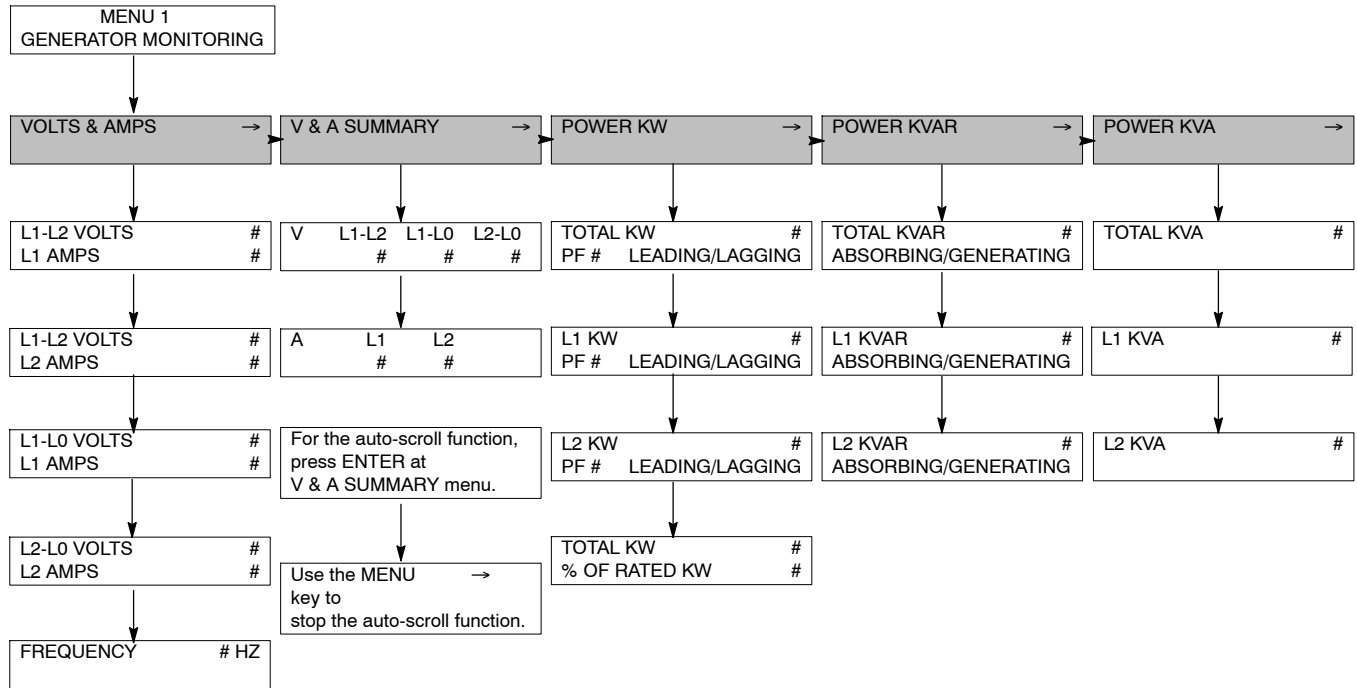

2.8.2 Menu 2—Engine Monitoring

Menu 2 displays engine operating data including oil pressure and temperature, coolant pressure and temperature, fuel pressure and temperature, engine rpm, and battery voltage. Menu 2 also displays engine warning and shutdown setpoints and engine warmed-up and cooled-down temperature setpoints. The detailed engine monitoring functions appear only for DDEC/JDEC/EMS2/EDC3-equipped engine and MDEC/ADEC-equipped engine versions.

Note: A right arrow from any submenu moves to the next submenu header.

Menu 2 Overview

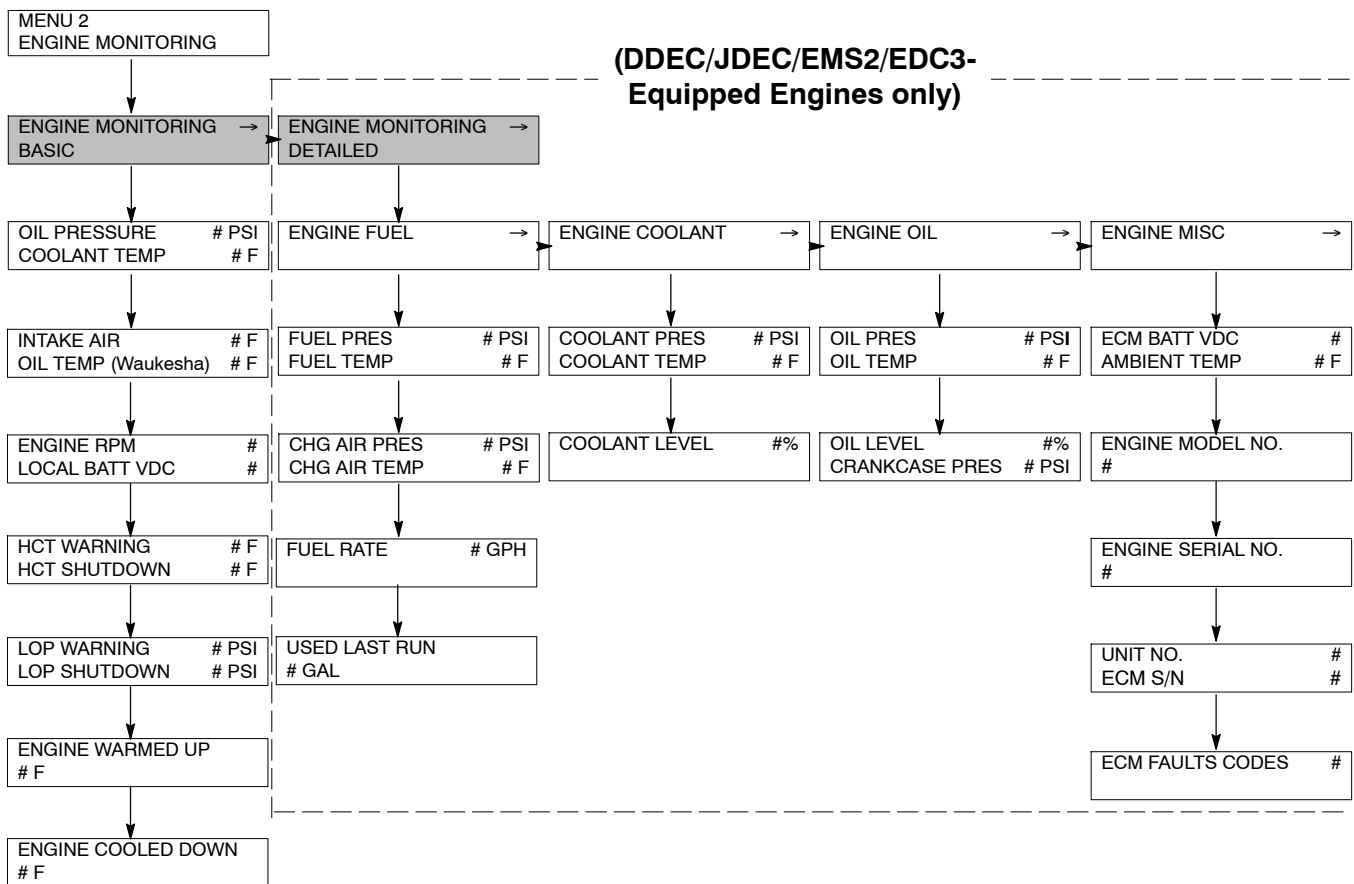

Menu 2 Overview

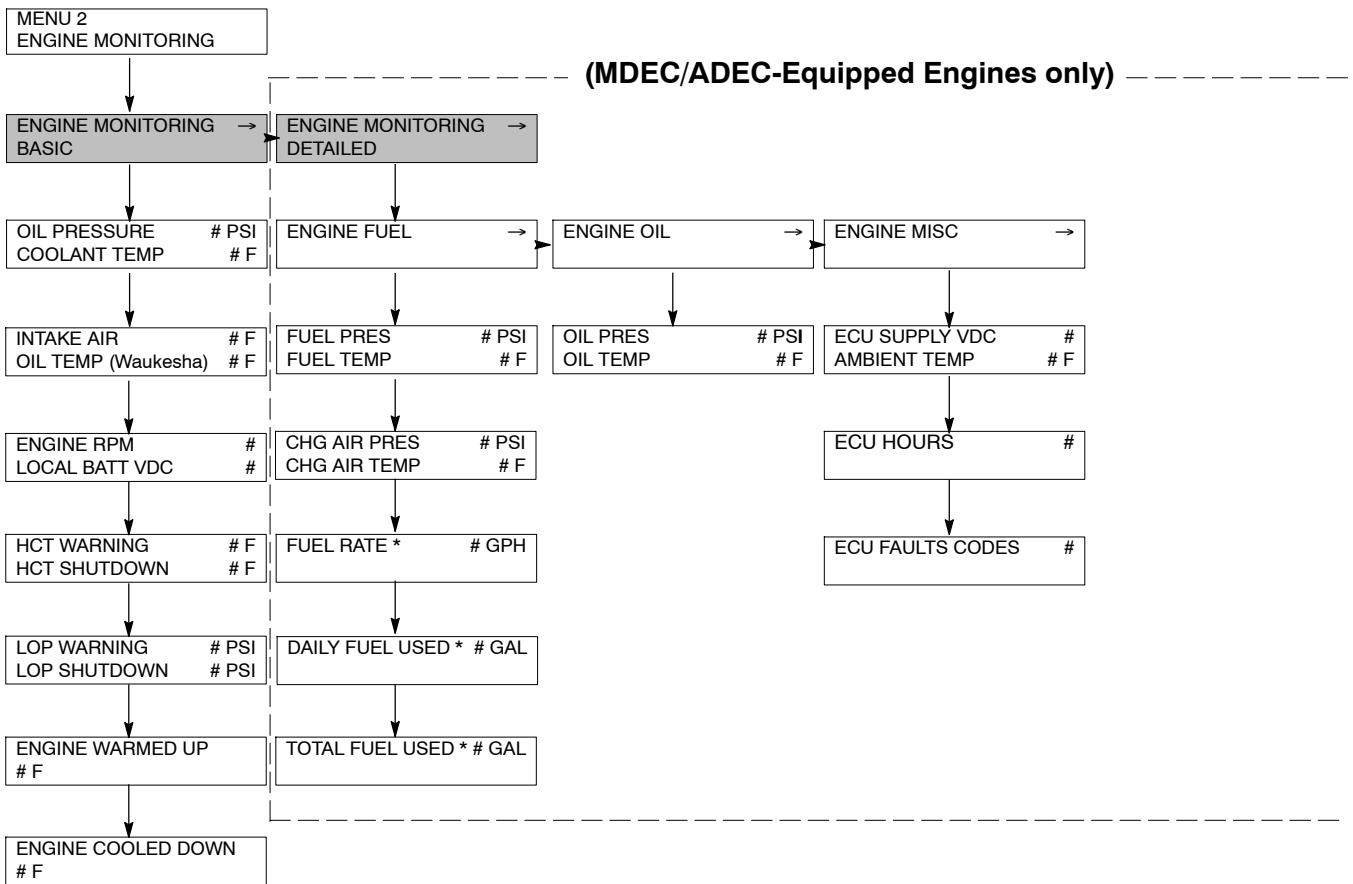

* While these menu displays do appear on the 550 controller, the engine ECM is not currently set up to provide this data.

2.8.3 Menu 3—Analog Monitoring

Menu 3 displays battery voltage and up to 7 user-defined analog items dependent upon the generator system.

The *User Defined Desc* display refers to a description entered into the controller using the PC software. This description remains as the display for future review until changed by the PC software user. The display has 20 characters maximum.

The default description is *Analog Auxiliary In*.

Note: If the analog display shows O/R (out of range), no input is connected or the input voltage is beyond the acceptable operating range (0–5 VDC).

Note: See **Figure 2-8** in User Inputs for factory reserved inputs which are not user selectable.

Menu 3 Overview (ECM Engines)

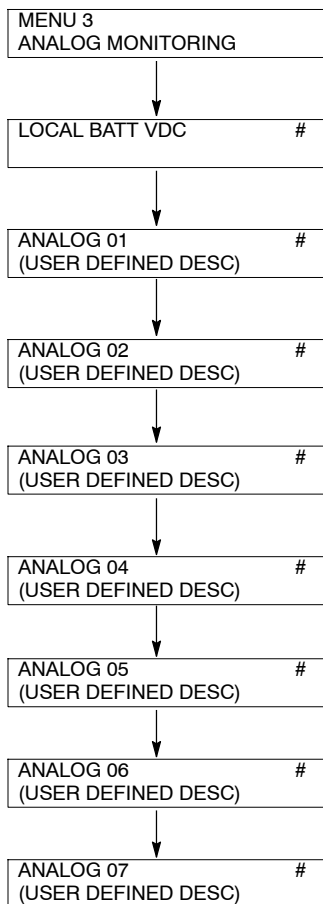

Menu 3 Overview (Non-ECM Engines)

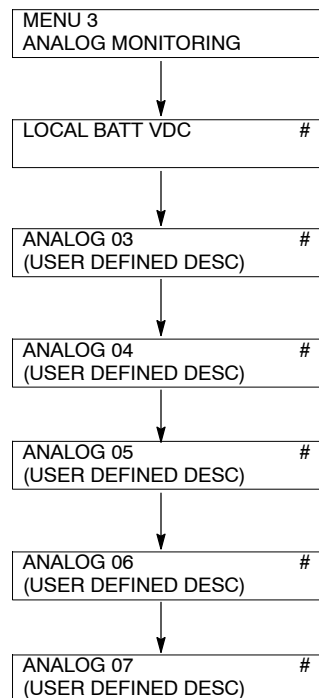

Menu 3 Overview (Waukesha Engines)

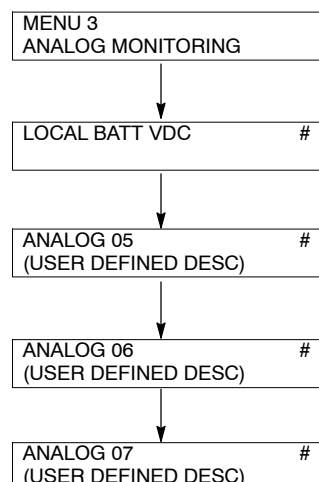

2.8.4 Menu 4—Operational Records

Menu 4 displays the generator set's operating record including operating start date, last logged maintenance, total run time loaded and unloaded, run time since last maintenance, number of starts, and number of days the unit ran.

After performing maintenance, enter YES to reset records reflecting the current day. The user must enable the programming mode to edit the display.

See Section 2.9.4 to make changes in this menu.

Menu 4 Overview

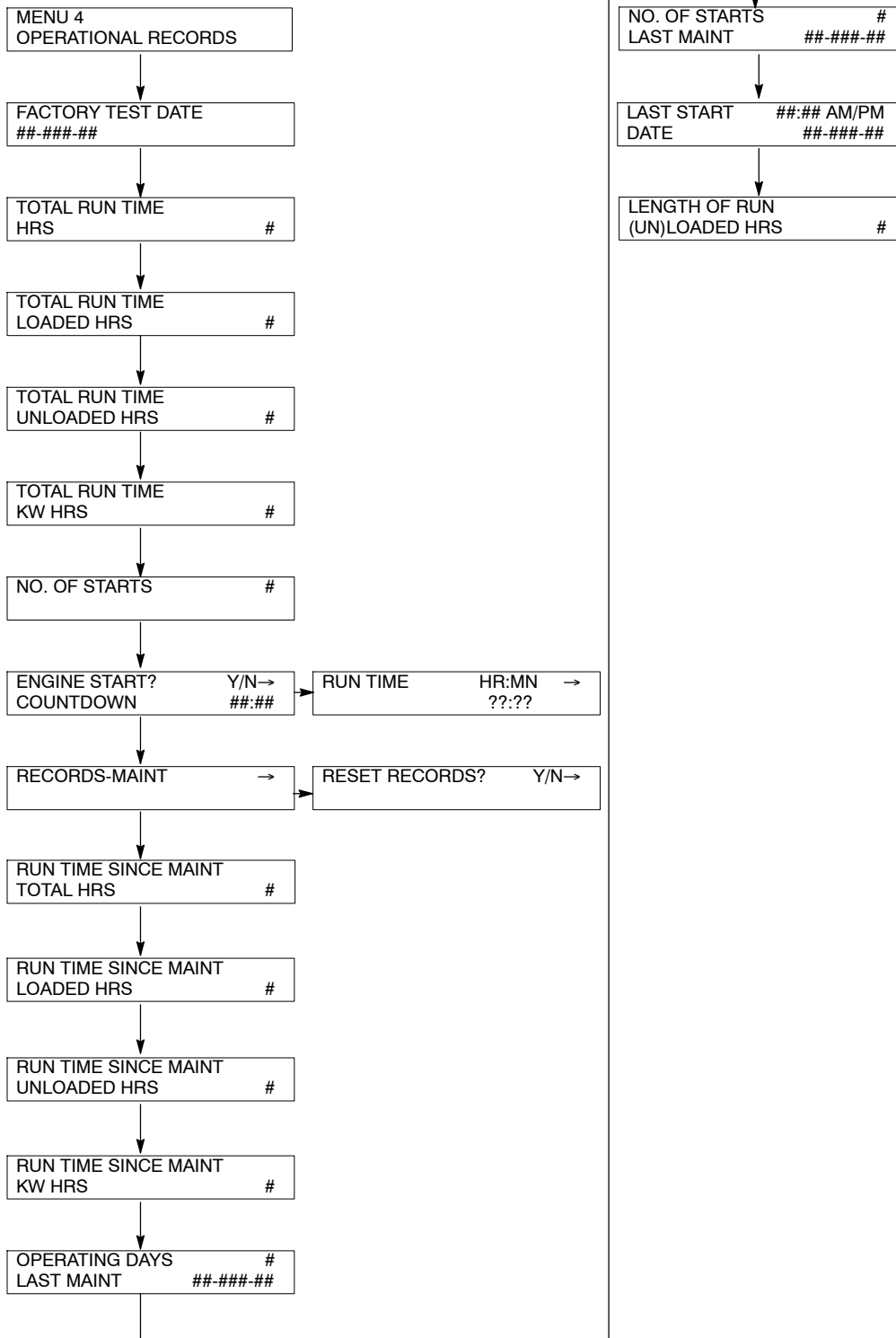

2.8.5 Menu 5—Event History

Menu 5 stores and displays the times and dates of up to 100 stored status, warning, and shutdown events. After the first 100 events, each additional new event replaces the oldest event. See Menu 10—Output Setup for a list of possible events.

Menu 5 Overview

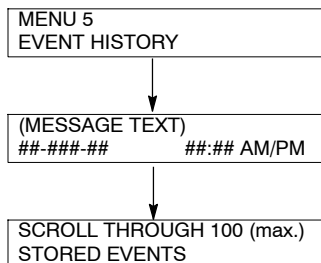

2.8.6 Menu 6—Time and Date

Menu 6 shows the internal clock time and calendar date. The controller uses the set clock time to determine exercise run time and event records. The time and date are valid as long as the controller power (starting battery) remains connected.

The user must enable the programming mode to edit the display.

See Section 2.9.6 to change the time and/or date.

Menu 6 Overview

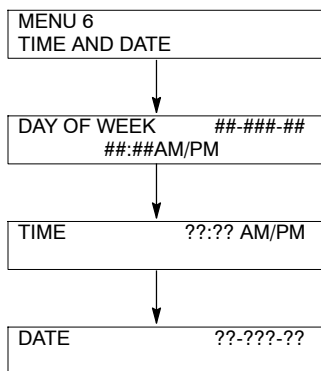

2.8.7 Menu 7—Generator System

Menu 7 shows the generator set system data including voltage, frequency, phase connection, battery voltage, etc. Use the values entered in this menu to determine shutdown values and time delays.

The user must enable the programming mode to edit the display.

See Section 2.9.7 to change system information in this menu.

Note: Press the Menu Right → key prior to entering decimal values where necessary.

Note: The user defines the data shown in Menu 7. It is NOT data measured by the controller and associated sensing devices. The user defines these values for purposes of calibrating the control.

Note: Some alternators are designed to operate at limited voltage, frequency, or phase connections. Settings outside of these parameters may cause a *range error* message.

Items marked * apply only to DDC/MTU engines using MDEC/ADEC.

Note: Menus include variable speed governor (VSG) and digital speed control (DSC).

Note: For Version 3.01 and higher, the Adjusted RPM Menu will display what the adjusted engine speed is from either an Analog input or the Keypad. When Digital VSG is selected the user can also enter a new Adjusted RPM in the Adjusted RPM menu.

Note: For Version 3.01 and higher, the Speed Adjust Select allows the user to select the type of adjustment for engine speed on Volvo, GM, Doosan and KDI engines. The user can select Analog VSG (where a potentiometer or external control device on Analog Input 6 is used to change the desired speed) or Digital VSG (where the user can enter a value on the key pad through the Adjusted RPM Menu just above).

Menu 7 Overview

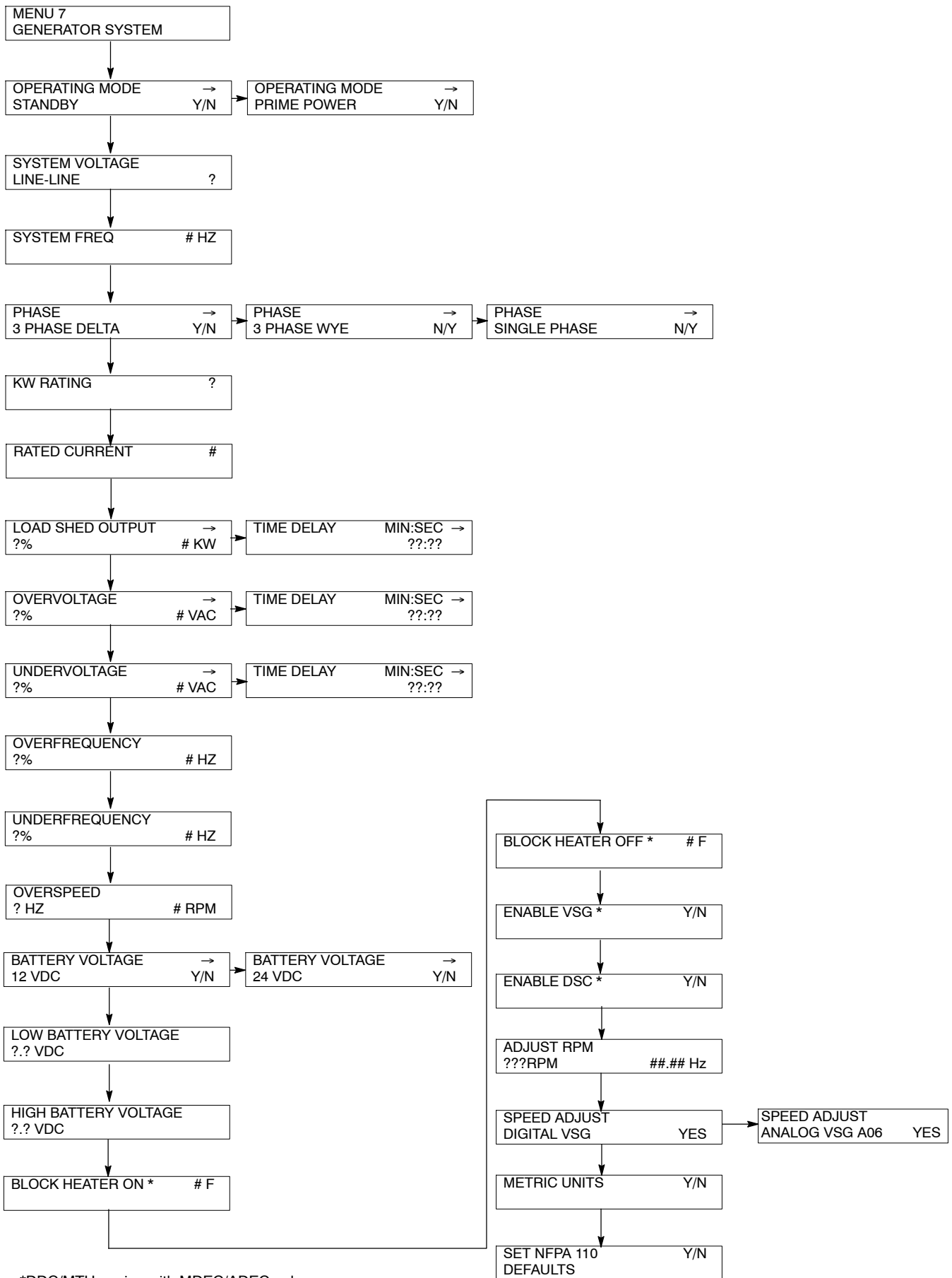

*DDC/MTU engine with MDEC/ADEC only

2.8.8 Menu 8—Time Delays

Menu 8 displays the cyclic cranking cycles, various engine related starting and shutdown features, and auxiliary shutdown and inhibit time delays.

The user must enable the programming mode to edit the display.

See Section 2.9.8 to change settings in this menu.

Cooldown Temperature Override. This feature allows the user to bypass (override) the temperature-based cooldown. When this feature is enabled, the engine will run in cooldown mode for the entire time defined as TIME DELAY ENG COOLDOWN, regardless of engine temperature.

Menu 8 Overview

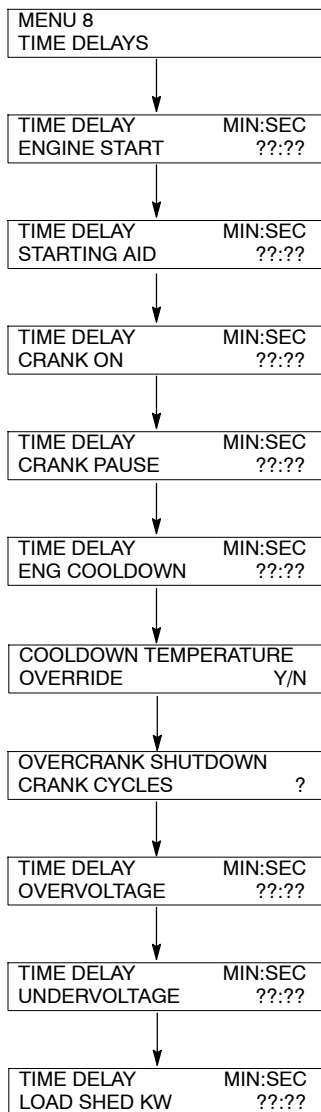

If the Cooldown Temperature Override is not enabled, the unit will cease to run when the engine temperature falls below the ENGINE COOLED DOWN temperature (shown in Menu 2).

Engine cooldown and this cooldown temperature override feature apply to remote shutdown when the master switch is in the AUTO position. No cooldown will occur when the master switch is moved to the OFF position.

2.8.9 Menu 9—Input Setup

Menu 9 displays the setup of user-defined digital and analog warning and shutdown inputs. These inputs provide a multitude of choices for configuring customized auxiliary inputs.

The user must enable the programming mode to edit the display.

See Section 2.9.9 to change settings in this menu.

Note: Press the down arrow to move to the start of the next input setup.

Note: See **Figure 2-8** in User Inputs for factory reserved inputs which are not user selectable.

- **Enabled.** The controller will ignore the input until the inhibit time expires. If the inhibit time is set to zero, the input is monitored at all times, even when the generator is not running. **Analog inputs** have separate warning and shutdown enabled choices.
- **Inhibit Time Delay.** The inhibit time delay is the time period following crank disconnect during which the generator set stabilizes and the controller does not detect the fault or status event. This menu indicates whether or not the input is enabled. If the input is not enabled, the controller will ignore this input signal. The inhibit time delay range is from 0 to 60 seconds.
- **Time Delay (shutdown or warning).** The time delay follows the inhibit time delay. The time delay is the time period between when the controller first detects the fault or status event and the controller warning or shutdown lamp illuminates. The delay prevents any nuisance alarms. The time delay range is from 0 to 60 seconds.

Additional Analog Input Entries. The analog input selection typically requires entering four values—low warning, high warning, low shutdown, and high shutdown.

Battle Switch/Emergency Mode/Fault Override Switch. The *battle* switch function forces the system to ignore normal fault shutdowns such as low oil pressure and high engine temperature. The battle switch does not override the emergency stop, overspeed, and overfrequency shutdowns. When the battle switch function is enabled the generator set continues to run regardless of shutdown signals where potential engine/generator damage can occur.

When this input is enabled the yellow warning lamp illuminates and stored warning/shutdown events that are ignored continue to log in Menu 5— Event History.

Shutdown Type A and Shutdown Type B. Choose **shutdown type A** for standard shutdown where red lamp illuminates and alarm horn sounds. Choose **shutdown type B** for shutdown where air damper indicator RDO-23 energizes for two seconds, red lamp illuminates, and alarm horn sounds.

Analog Input A06—Analog Speed Adjust (VSG). Analog Input A06 may be used for analog speed adjust when external control of engine speed is desired such as paralleling applications or closed transition ATS. To utilize this capability,, “ANALOG VSG A06” must be selected from the Speed Adjust Selection. Refer to 2.9.7, Menu 7.

Note: For controller firmware versions prior to 3.4.3, analog input A06 must be calibrated. Refer to 2.9.12, Menu 12—Calibration.

Note: This feature is supported for Doosan, GM, Volvo, and KDI engines only.

Analog Input A07—Analog Voltage Adjust. Analog voltage adjust is a feature that the user may choose to enable. The input designated for use as Analog Voltage Adjust is analog input A07.

Enable Analog Voltage Adjust through Menu 11. Additionally, Monitor 2 or Monitor 3 may be used to enable Analog Voltage Adjust by entering the proper description (*Analog Volt Adjust*) for A07. When Analog Voltage Adjust is enabled, the description for A07 is *Analog Volt Adjust*. Changing the description using Monitor 2 or Monitor 3 disables the analog voltage adjust feature.

When Analog Voltage Adjust is enabled, no warning or shutdown may be enabled for A07.

Note: If the analog input A07 description does not match *Analog Volt Adjust*, input A07 will **not** function as the voltage adjust.

Identification and Descriptions. Descriptions for user inputs (auxiliary analog or auxiliary digital) may be entered using the Monitor II software accessory where the user determines the descriptions in upper and lower case.

Menu 9 Overview

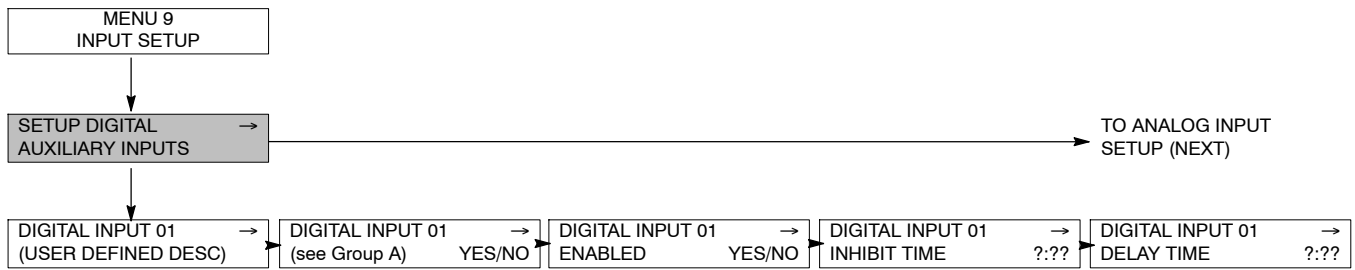

Press the down arrow to scroll through additional DIGITAL auxiliary inputs 1-21 or enter the input number.

Group A

The preprogrammed selections include the following list. See Appendix E for application and restrictions with specific engines.

WARNING	Y/N
SHUTDOWN TYPE A	Y/N
SHUTDOWN TYPE B	Y/N
VOLTAGE RAISE	Y/N
VOLTAGE LOWER	Y/N

Group A, continued

VAR PF MODE	Y/N
REMOTE SHUTDOWN	Y/N
REMOTE RESET	Y/N
AIR DAMPER	Y/N
LOW FUEL	Y/N
FIELD OVERVOLTAGE	Y/N
IDLE MODE ACTIVE	Y/N
BATTLE SWITCH	Y/N
GROUND FAULT	Y/N
BAT CHGR FAULT	Y/N
HIGH OIL TEMP	Y/N

Group A, continued

LOW COOLANT LEVEL	Y/N
LOW COOLANT TEMP	Y/N
BREAKER CLOSED	Y/N
ENABLE SYNCH	Y/N
AFM SHUTDOWN	Y/N
KNOCK SHUTDOWN	Y/N
DETON WARNING	Y/N
DETON SHUTDOWN	Y/N
LOW FUEL SHUTDOWN	Y/N

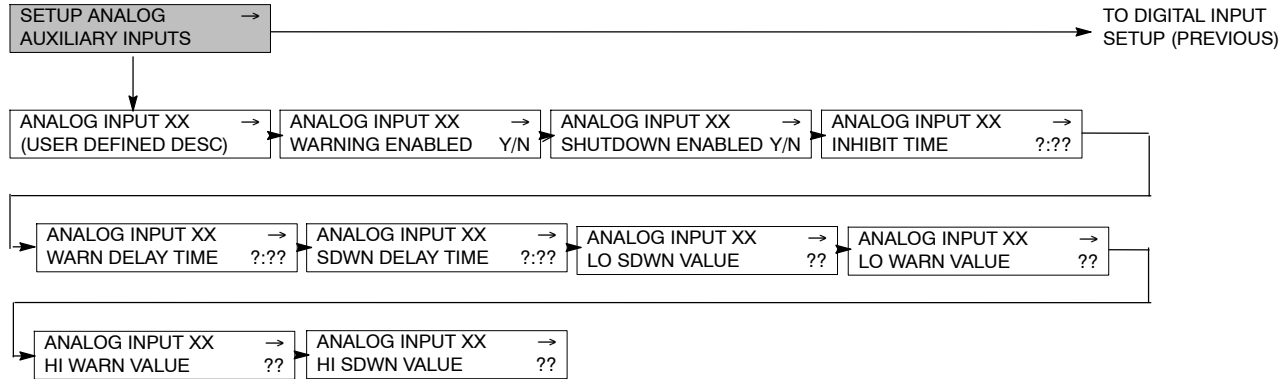

Note: For ECM engines, auxiliary analog inputs A01-A07 will appear.

Note: For non-ECM engines, auxiliary analog inputs A03-A07 will appear.

Note: For Waukesha engines, auxiliary analog inputs A05-A07 will appear.

2.8.10 Menu 10—Output Setup

Menu 10 displays the setup of user-defined system, digital and analog status, and fault outputs and relay driver outputs (RDO) 1–31. These RDO outputs provide multiple choices for configuring customized auxiliary outputs. Additional individual outputs are available for monitoring, diagnostics, and control functions.

The user must enable the programming mode to edit the display. See Section 2.9.10 to change this menu.

Note: Some data require entry using a PC in the Remote Programming mode. See the Monitor Software operation manual for details.

Note: See **Figure 2-8** in User Inputs for factory reserved inputs which are not user selectable.

Common Faults

The user can program a single fault comprised of faults from 3 common fault programs—system, digital, and analog faults.

Up to 62 user-defined *system* status events and faults are available. See Group B on the following pages for specific descriptions. The NFPA 110 faults are part of the *system* fault program and are comprised of 15 individual faults shown on the next page.

The user can select up to 21 user-defined *digital* status events and faults designated as D01 to D21. Each of the 21 status events and faults are assignable as shutdowns or warnings.

The user can select up to 7 user-defined *analog* status events and faults designated as A01 to A07. Each of the 7 status events and faults are assignable as shutdowns or warnings with high or low settings for a total of up to 7 status events and fault functions.

Relay Driver Outputs (RDOs)

Up to 31 RDOs are available using the system, digital, and analog status events and faults. RDOs provide only the driver. The contact relays that interface with other equipment are optional.

Note: *Func(tion) Used By (RDO) XX Reassign?* error message appears when the user attempts to duplicate an existing RDO selection.

Note: *Cannot Change NFPA is Enabled.* error message appears when the user attempts to modify RDO setting defaulted as NFPA 110 requirement.

Menu 10 Overview

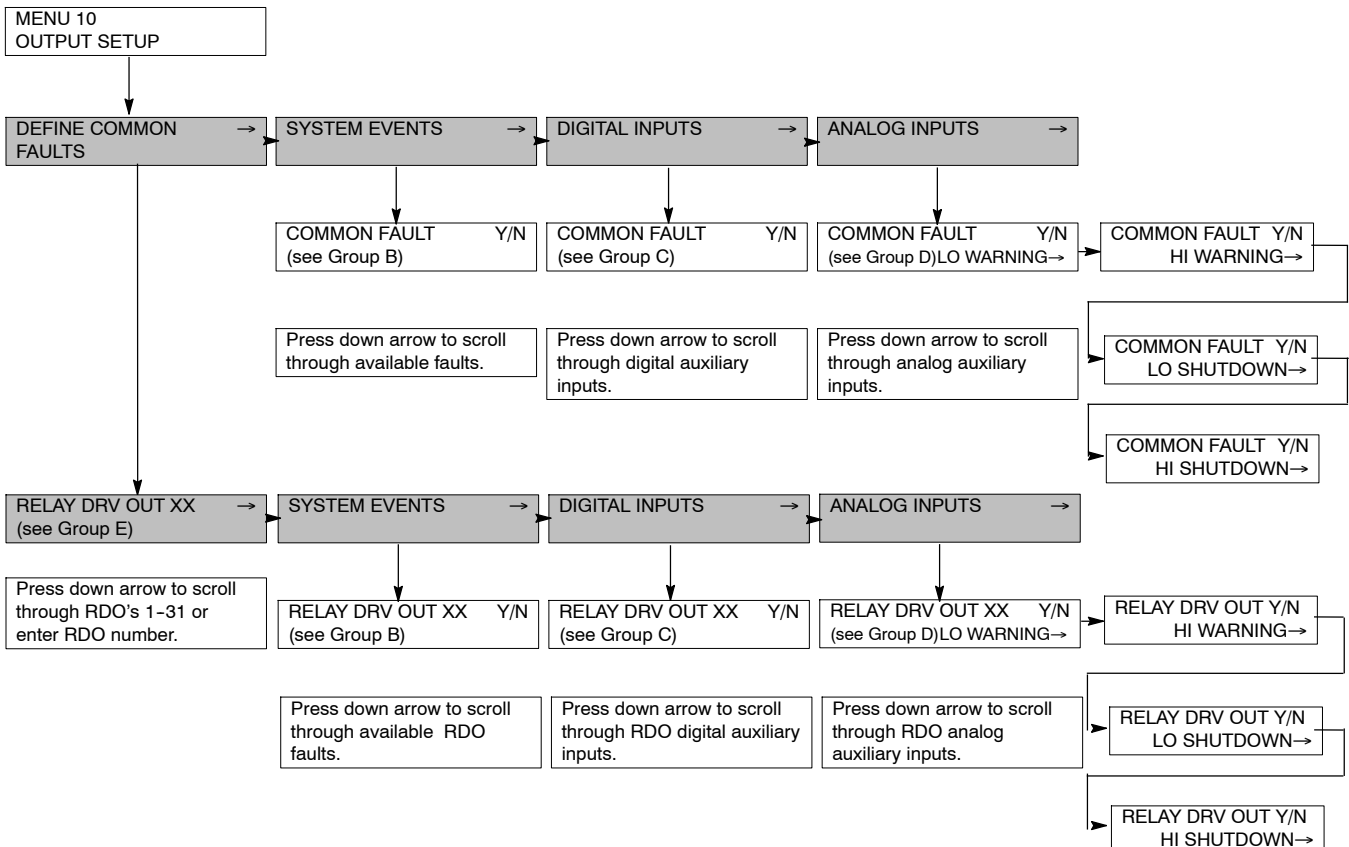

Menu 10 Overview, continued

Group B

For defined system events, choose from the following 66 status events and faults by changing selection to YES. See Appendix E for application and restrictions with specific engines.

EMERGENCY STOP
OVER SPEED
OVER CRANK
HI COOL TEMP SHUTDWN
OIL PRESS SHUTDOWN
LOW COOLANT TEMP (non-ECM engines)
LOW FUEL
HI COOL TEMP WARNING
OIL PRES WARNING
MASTER NOT IN AUTO
NFPA 110 FAULT*
LOW BATTERY VOLTAGE
HIGH BATTERY VOLTAGE
BATTERY CHARGE FAULT
SYSTEM READY
LOSS OF ECM COMM (ECM engines)
NO OIL PRESS SIGNAL
HI OIL TEMP
NO COOL TEMP SIGNAL
LOW COOLANT LEVEL
SPEED SENSOR FAULT
LOCKED ROTOR
MASTER SWITCH ERROR
MASTER SWITCH OPEN
MASTER SWITCH TO OFF
AC SENSING LOSS
OVER VOLTAGE
UNDER VOLTAGE
WEAK BATTERY
OVER FREQUENCY
UNDER FREQUENCY
LOAD SHED KW OVER
LOAD SHED UNDER FREQ
OVER CURRENT
EPS SUPPLYING LOAD
INTERNAL FAULT
DELAY ENG COOLDOWN
DELAY ENG START
STARTING AID
GENERATOR RUNNING
AIR DAMPER CONTROL
GROUND FAULT
EEPROM WRITE FAILURE
CRITICAL OVERVOLTAGE
ALTERNATOR PROTECTION SHUTDOWN
AIR DAMPER INDICATOR
DEFINED COMMON FAULT (RDO only)†
SCRDOs 1-4 (software controlled RDOs)
MAINTENANCE DUE
ENGINE DERATE ACTIVE
ENGINE STALLED
J1939 CAN SHUTDOWN

*NFPA 110 FAULT

The 15 NFPA 110 Fault Alarms include the following:
OVERSPEED
OVERCRANK
HIGH COOLANT TEMP SHUTDOWN
OIL PRESSURE SHUTDOWN
LOW COOLANT TEMPERATURE
HIGH COOLANT TEMP WARNING
OIL PRESSURE WARNING
LOW FUEL
MASTER NOT IN AUTO
BATTERY CHARGER FAULT
LOW BATTERY VOLTAGE
HIGH BATTERY VOLTAGE
LOW COOLANT LEVEL
EPS SUPPLYING LOAD
AIR DAMPER INDICATOR

†DEFINED COMMON FAULT

The 5 defined common faults include the following:
EMERGENCY STOP
HI COOL TEMP SHUTDOWN
OIL PRESS SHUTDOWN
OVERCRANK
OVERSPEED

Group B, continued

Paralleling applicatons:

SD REVERSE POWER
SD OVER POWER
SD LOSS OF FIELD
SD OVERCURRENT PR
COMMON PR OUTPUT
IN SYNCH
BREAKER TRIP

Waukesha-powered models:

FUEL VALVE RELAY
PRELUBE RELAY
AFM REMOTE START
NO OIL TEMP SIGNAL
HI OIL TEMP WARNING
NO AIR TEMP SIGNAL
INTAKE AIR TEMP WARN
INTAKE AIR TEMP SDWN
AFM ENG START DELAY

DDC/MTU engine with MDEC/ADEC:

HI OIL TEMP WARNING
INTAKE AIR/TEMP WARN
INTAKE AIR TEMP SDWN
ECM YELLOW ALARM
ECM RED ALARM
BLOCK HEATER CONTROL
LOW COOL TEMP SDOWN
LOAD SHED OVER TEMP

1750/2000REOZMD:

TURBO TEMP WARNING
TURBO TEMP SHUTDOWN

Group C

Up to 21 user-defined digital status events and fault inputs designated as D01 to D21 can result in a digital input common fault.

Group D

Up to 7 analog inputs, user-defined status events and faults designated as A01 to A07. Each of the 7 is assignable as a shutdown or warning with high or low settings.

Group E

Choose up to 31 status event and fault RDOs from the following:

SYSTEM FAULTS
(see Group B, 66 Items)
DIGITAL INPUTS
(see Group C, 21 Items)
ANALOG INPUTS
(see Group D, 7 Items)

2.8.11 Menu 11—Voltage Regulator

Menu 11 displays setup of the voltage regulator functions including line-to-line voltages, underfrequency unloading (volts per Hz), reactive droop, power factor, and kVAR adjustments.

The user must enable the programming mode to edit the display.

See Section 2.9.11 to make changes in this menu.

Note: The individual line-to-line voltages are displayed for review purposes only.

Note: Voltage regulator gain is used for adjusting voltage stability and/or response.

Note: Utility gain is used for VAR or PF stability adjust while paralleling to a utility.

Menu 11 Overview

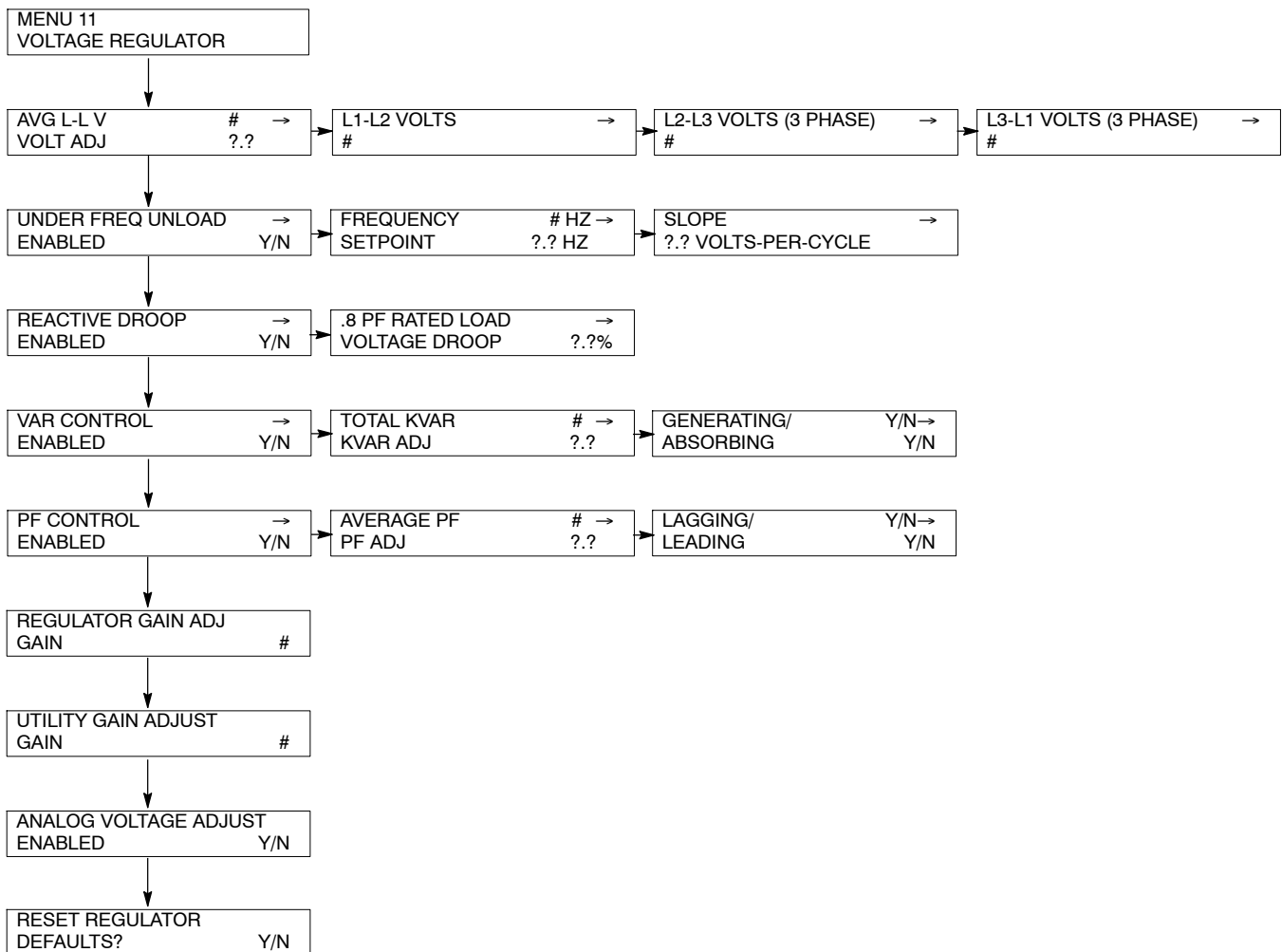

2.8.12 Menu 12—Calibration

Menu 12 provides access to the calibration factors for metering (volts and amps) and auxiliary analog inputs. Changing the system voltage or replacing the main logic control circuit board requires calibration adjustment.

The user must enable the programming mode to edit the display.

See Section 2.9.12 to make calibration changes.

Menu 12 Overview

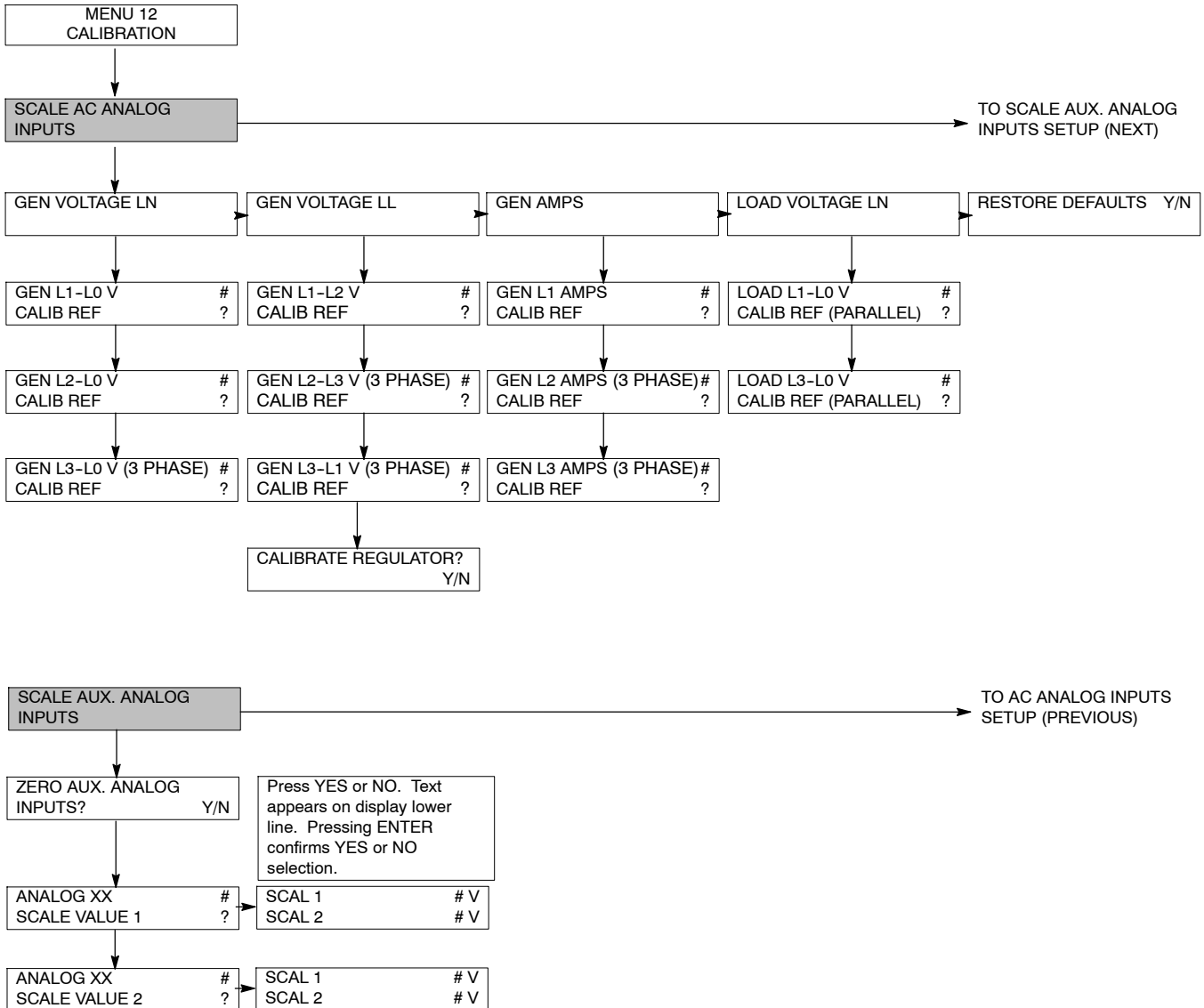

2.8.13 Menu 13—Communications

Menu 13 shows the settings for remote communications.

See Section 2.9.13 to make changes in this menu.

See the Modbus® Communications Protocol operation manual for a list of Modbus® registers for the 550 Controller.

Menu 13 Overview

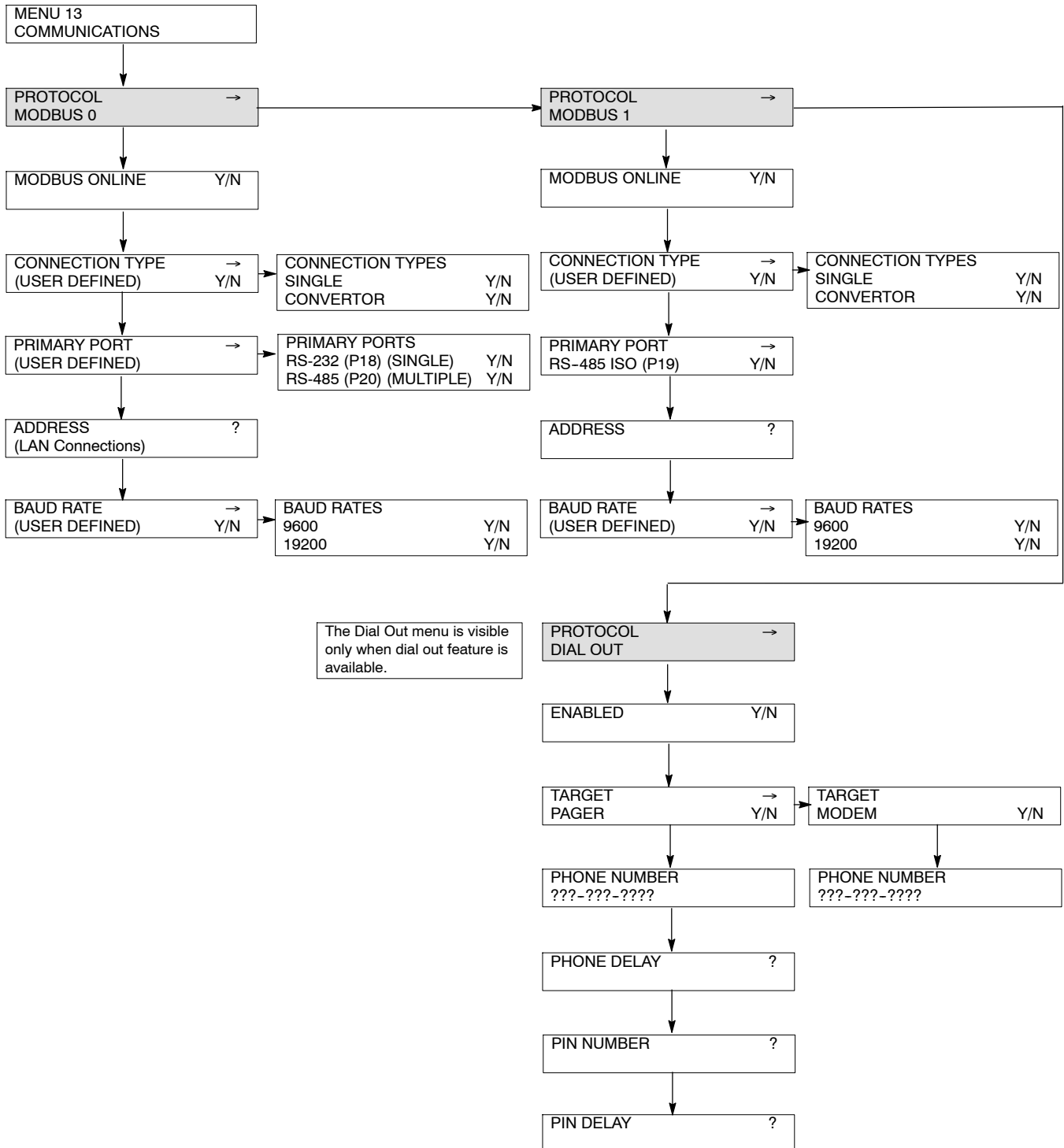

Modbus® is a registered trademark of Schneider Electric.

2.8.14 Menu 14—Programming Mode

Menu 14 provides local or remote access to the programming function. The user enters a password to access the programming mode.

Note: Log into the *local* programming mode to edit the programming access code. *The factory default access code is the number 0.*

Use Menu 14 to change the access code. Record the new number and give the access code only to authorized individuals. Should the controller logic not accept the access code or if the new code number is lost, contact your local authorized distributor/dealer for password information.

The user chooses one of three programming modes:

- Local—using the controller keypad
- Remote—using a PC
- Off—no programming is permitted

Note: Use the generator set controller to initially set up remote programming. Remote programming cannot be accessed from a PC unless the controller is first set for remote programming using Menu 14.

See Section 2.9.14.

Menu 14 Overview

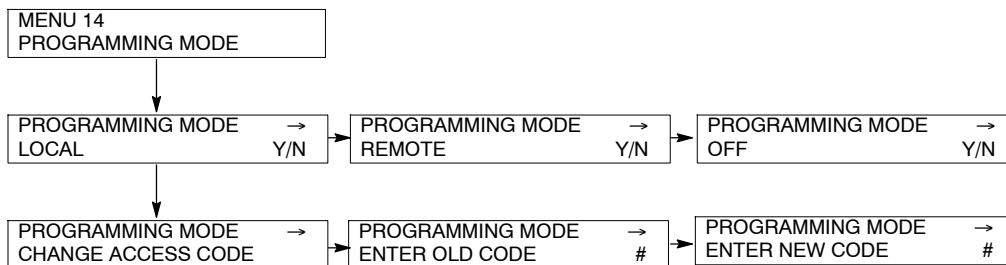

2.8.15 Menu 15—Protective Relays (PR)

Menu 15 provides protective relay setup and time delays for units with the paralleling protection option. This menu will only be visible and accessible if this option is included. The shutdown (SD) settings override those in menu 7 and/or menu 8.

See Section 2.9.15 to make changes in this menu, when the paralleling option is enabled.

Menu 15 Overview

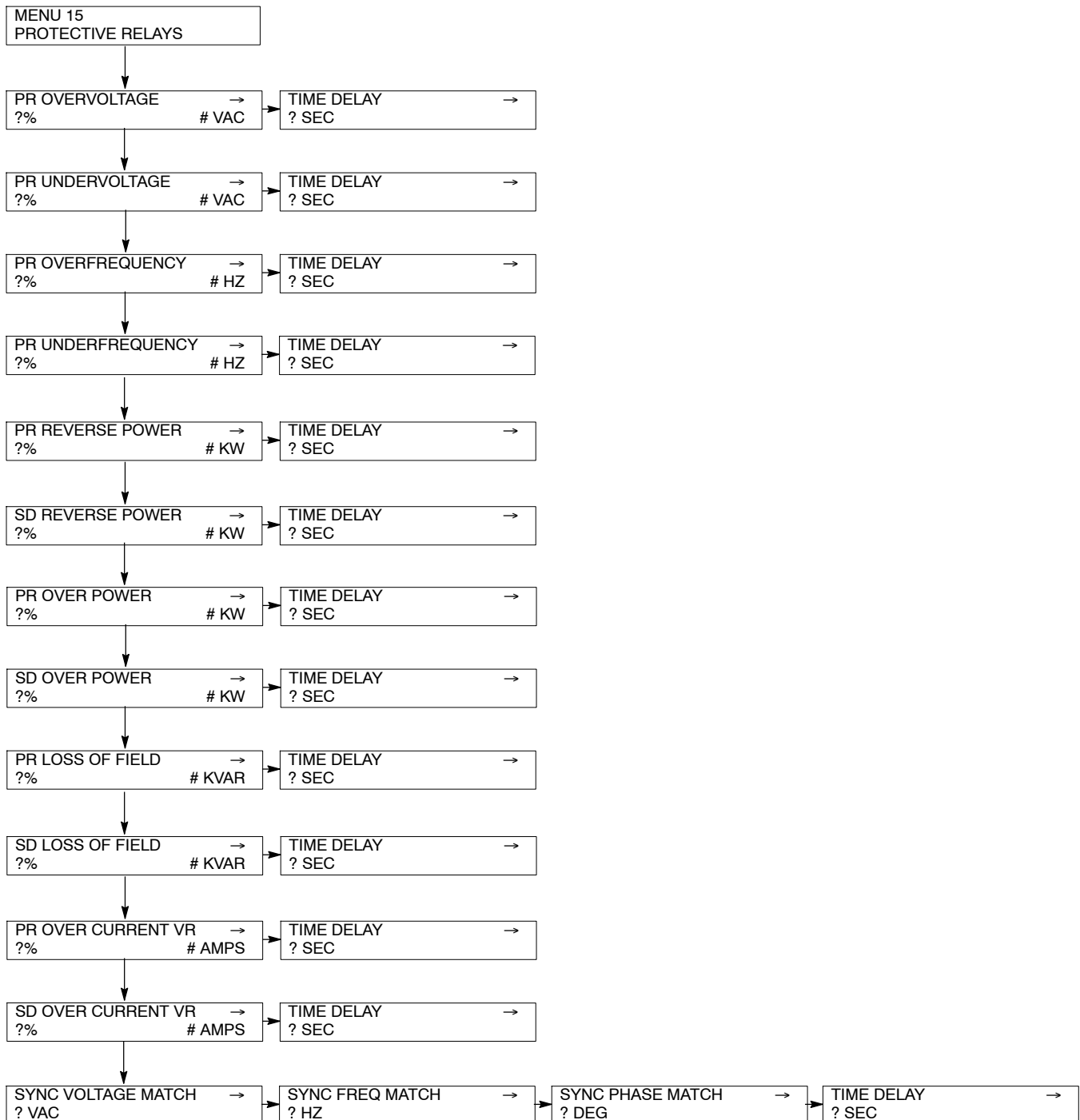

2.8.16 Menu 18—Battery Chargers (Version 3.4.3 or Higher)

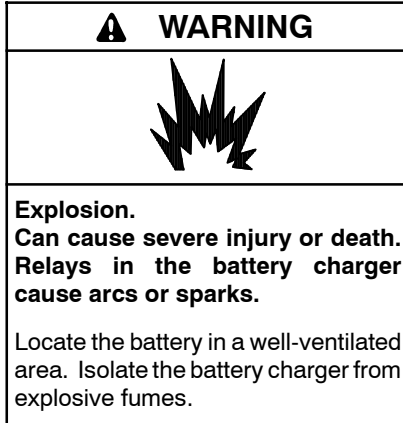

Battery gases. Explosion can cause severe injury or death. Incorrect use of the equalize charge state may lead to hazardous situations. Equalization is ONLY applicable for flooded lead acid (FLA) type batteries and will damage gel, absorbed glass mat (AGM), or nickel-cadmium (NiCad) type batteries. In the controller menu or SiteTech™ settings, verify that the battery topology is set correctly for the battery type used. Do not smoke or permit flames, sparks, or other sources of ignition to occur near a battery at any time.

Menu 18 provides battery charger information, settings, and parameter configurations. Use this menu to view the battery metering and output state and to change or enable parameter settings such as equalize charge and temperature compensation. For more information on parameters, refer to the battery charger operation manual and the battery manufacturer's recommended specifications.

Note: Incorrect charger output system voltage may cause irreversible damage to the battery and abnormal out gassing. Ensure that the battery charger parameters match the battery manufacturer's specifications before using. In the controller user interface settings, verify that the battery topology and system voltage is set correctly for the battery type that is used.

Note: The battery charger menus are designed to work with charger GM87448. Unless connected to charger GM87448 through CAN communication, the battery charger menus, although visible, have no effect on the battery charger.

Menu 18 Overview, continued

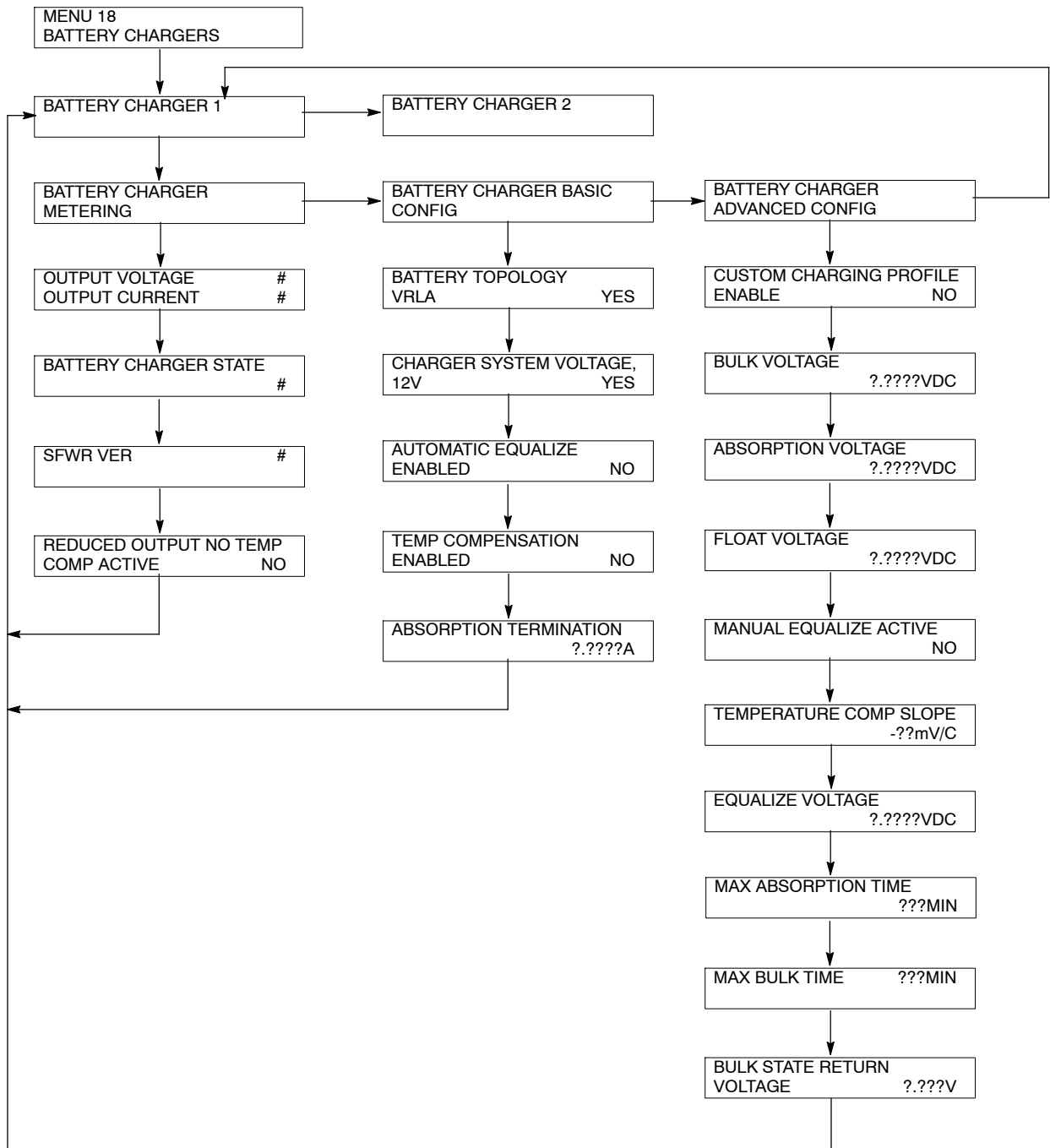

2.8.17 Menu 20—Factory Setup (Version 2.10)

Menu 20 provides factory setup information including the number of operating days, generator set information, alternator information, engine information, controller information, and the controller software (code) version.

Menu 20 Overview

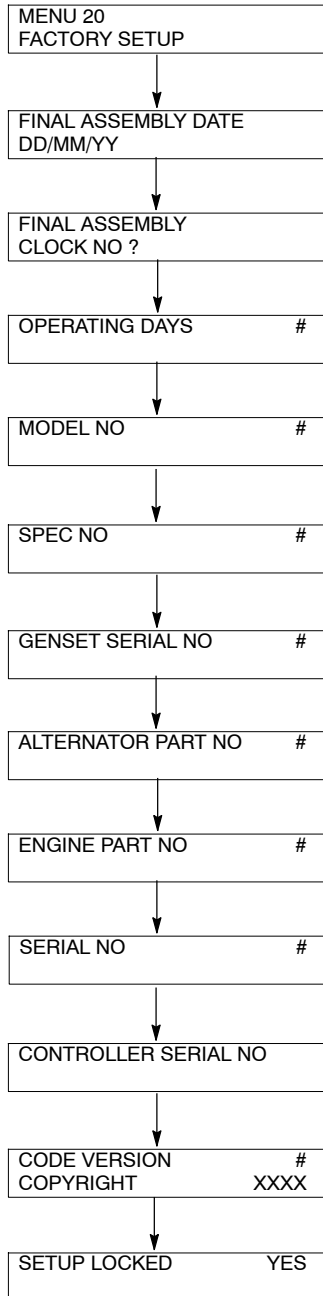

2.8.18 Menu 20—Factory Setup (Version 2.21)

Menu 20 provides factory setup information including the number of operating days, generator set information, alternator information, engine information, controller information, and the controller software (code) version. The temperature sensor setup applies to non-ECM engines only.

See Section 2.9.17 to make changes in this menu.

Menu 20 Overview

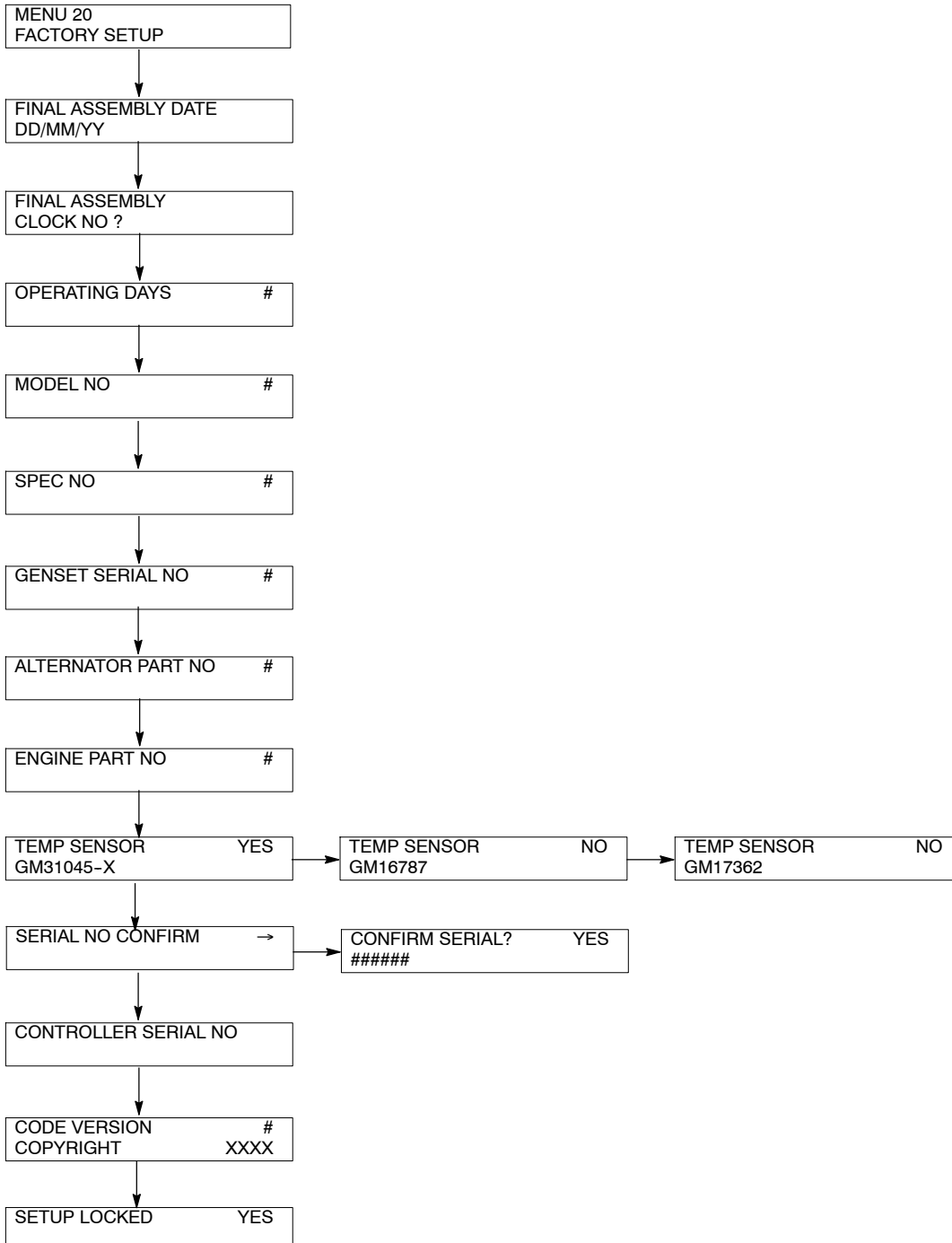

Note: For Version 2.69 and lower, enter the numeric serial number from the generator set nameplate. For Version 2.70 and higher, confirm that the alpha-numeric number shown on the display matches the serial number shown on the generator set nameplate. If the serial numbers match, press the YES key and then press ENTER. If the serial numbers do not match, the wrong personality parameter file is installed. Refer to the Program Loader documentation for instructions on reloading the personality parameter file.

2.8.19 Menu 20—Factory Setup (Version 3.01)

Menu 20 provides factory setup information including the number of operating days, generator set information, alternator information, engine information, controller information, and the controller software (code) version. The temperature sensor setup applies to non-ECM engines only.

See Section 2.9.17 to make changes in this menu.

Note: For Version 3.01 and higher, the Engine Type Is displayed for engines with an ECM. The Correct Engine Type is not displayed until the Engine has run.

Note: For Version 3.01 and higher, the Low Coolant Temp Warning can be disabled on units with non-ECM engines that are not required to meet NFPA 110. As with older version of firmware on ECM engines, the LCTW may be disabled by selecting **NO** for Warning Enabled, for the respective input. Refer to section 2.9.7 for disabling NFPA defaults and refer to section 2.9.9 for configuration of digital inputs.

Menu 20 Overview

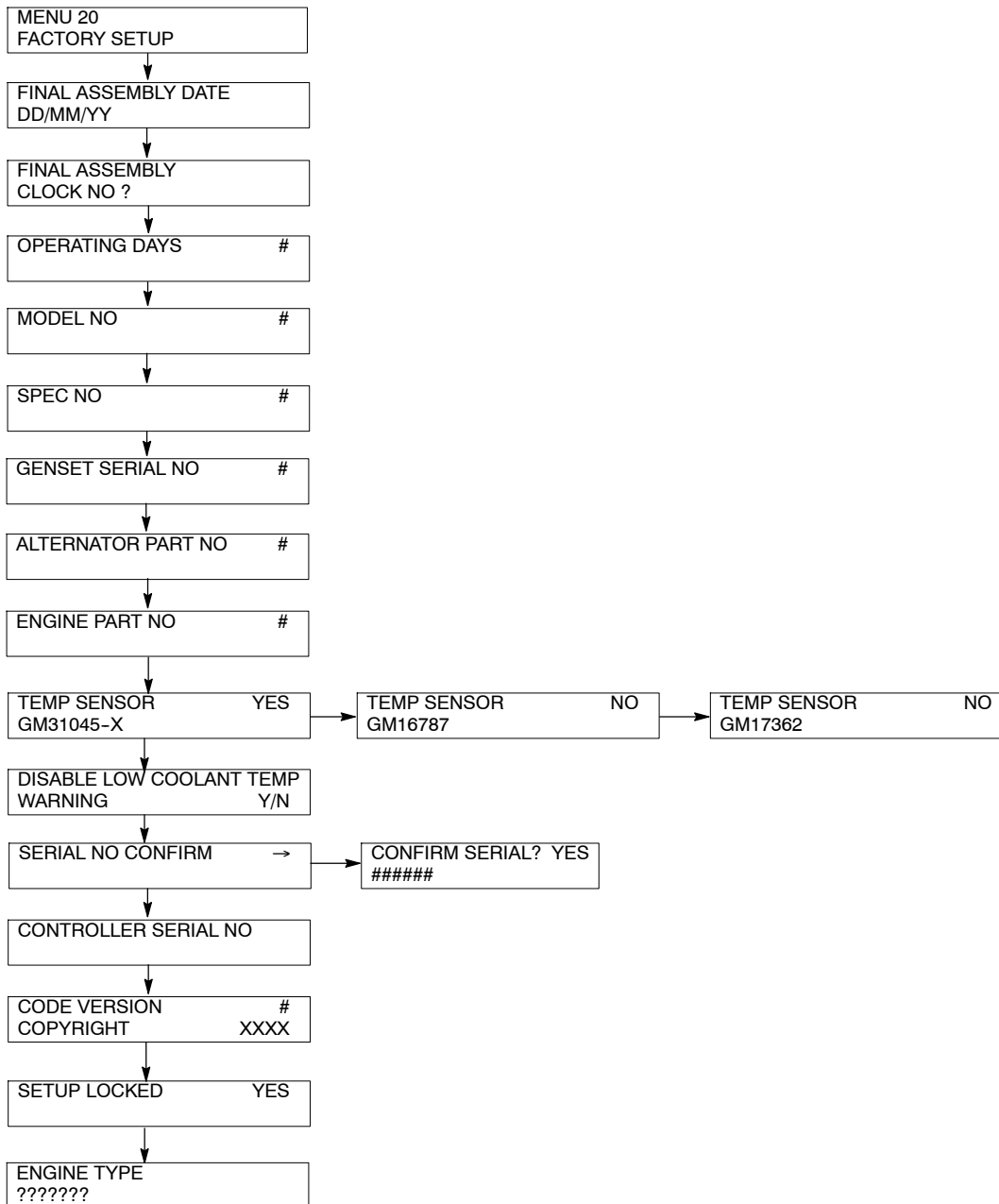

2.9 Local Programming Mode On

The Local Programming Mode On section explains how to program the generator set controller logic. Each menu contains a step-by-step procedure for programming the various logic groups. See Section 1, Specifications, for setting ranges and default settings.

Please read and understand the entire Local Programming Mode On section before attempting any programming. The factory settings are adjustable and programming without full understanding of the logic features and functions can cause inadvertent changes.

Refer to Menu 14—Programming Mode for information regarding menu programming activation. After completing the programming always *place the controller back in the Programming Mode Off position* to prevent inadvertent program changes.

The programming feature alters stored settings and changes characteristics of the logic. Do not operate the controller with the program mode on unless there is a need to edit program logic or clear stored data. Limit programming responsibilities to individuals with training and authority.

The product application requires expertise in the design and programming of control systems. Only qualified personnel should program, install, alter, and apply this product.

Use Section 2.8, Reviewing the Menu Displays, to view the generator set operation data and review previously programmed information and to review the data when no programming is necessary.

Menus displaying the # symbol represent one of the following data types:

- System-calculated data
- System-measured data
- User-entered data

Menus displaying the ? symbol require the user to enter data.

Menus displaying the * symbol represent access code or password type entries. Actual key entry does not display.

See Section 2.6.3, Request and Error Messages, for error display messages and explanations should they appear while navigating through the menus.

All menu displays apply to both single-phase and three-phase voltages unless otherwise noted as (1 PH) or (3 PH) on the menu overview. The phase designation does not appear in the actual menu displays.

Note: Place the generator set master switch in the OFF/ RESET position when using local programming mode on.

Note: Use the generator set controller to initially set up the remote programming. Set the controller for remote programming using Menu 14 and remote communication using Menu 13 before attempting remote programming.

Note: Press any key on the keypad to activate the controller panel display. The panel display turns off 5 minutes after the last keypad entry.

Note: Press the Reset Menu key to clear the Error display.

Note: Press the Menu Right → key prior to entering decimal values where necessary.

Refer to Figure 2-18 for a quick reference to the menu number and description.

Menu No.	Menu Description
1	Generator Monitoring (Three-Phase Connections)
1	Generator Monitoring (Single-Phase Connections)
2	Engine Monitoring
3	Analog Monitoring
4	Operational Records
5	Event History
6	Time and Date
7	Generator System
8	Time Delays
9	Input Setup
10	Output Setup
11	Voltage Regulator
12	Calibration
13	Communication
14	Programming Mode
15	Protective Relays
18	Battery Chargers
20	Factory Setup Menu

Figure 2-18 Menu Number and Description

2.9.1 Menu 1—Generator Monitoring

Menu 1 provides generator output data including line-to-line and line-to-neutral voltages, current, frequency, power factor, total kilowatts, percent of maximum kW, total kVA and total kVAR displays. Menu 1 displays three-phase and single-phase connections separately.

Note: For the auto-scroll function, press ENTER at the V & A Summary menu. Press the Reset Menu key or Menu Right → key to stop the auto-scroll function.

Note: A right arrow from any submenu moves to the next submenu header.

Menu 1—Generator Monitoring (Three-Phase Connections)



















Menu 1 Displays with Key Entries

Note: This menu is for monitoring only; no adjustments or user settings can be entered.

Key Entry	Display	Description
	ENTER MENU NO. 1-15	Input a menu number.
	MAIN MENU NUMBER 1	Press the Enter key.
	MENU 1 GENERATOR MONITORING	Displays the menu number and name.
	VOLTS & AMPS →	Displays the volts and amps heading.
	L1-L2 VOLTS # L1 AMPS #	Displays L1 and L2 volts and L1 amps.
	L2-L3 VOLTS # L2 AMPS #	Displays L2 and L3 volts and L2 amps.
	L3-L1 VOLTS # L3 AMPS #	Displays L3 and L1 volts and L3 amps.
	L1-L0 VOLTS # L1 AMPS #	Displays L1-L0 volts and L1 amps.
	L2-L0 VOLTS # L2 AMPS #	Displays L2 and L0 volts and L2 amps.
	L3-L0 VOLTS # L3 AMPS #	Displays L3-L0 volts and L3 amps.
	FREQUENCY # HZ	Displays the frequency.
	MENU 1 GENERATOR MONITORING	Returns the user to the menu number and name.
	VOLTS & AMPS →	Returns the user to volts and amps heading.
	V & A SUMMARY →	Displays the volts and amps summary heading.
	V L1-L2 L2-L3 L3-L1 # # #	Displays L1-L2, L2-L3, and L3-L1 volts.
	V L1-L0 L2-L0 L3-L0 # # #	Displays L1-L0, L2-L0, and L3-L0 volts. (3 ph. only)



Menu 1—Generator Monitoring (Three-Phase Connections), continued

Menu 1 Displays with Key Entries

Key Entry	Display	Description
	A L1 L2 L3 # # #	Displays L1, L2, and L3 amps.
	V & A SUMMARY →	Returns the user to the volts and amps summary heading.
	POWER KW →	Displays the power kilowatt heading.
	TOTAL KW # PF # LEADING/LAGGING	Displays total kilowatts and leading or lagging power factor.
	L1 KW # PF # LEADING/LAGGING	Displays total L1 kilowatts and leading or lagging power factor.
	L2 KW # PF # LEADING/LAGGING	Displays total L2 kilowatts and leading or lagging power factor.
	L3 KW # PF # LEADING/LAGGING	Displays total L3 kilowatts and leading or lagging power factor.
	TOTAL KW # % OF RATED KW #	Displays the total kW and percent of rated kilowatts.
	POWER KW →	Returns the user to the power kilowatt heading.
	POWER KVAR →	Displays the power kVAR heading.
	TOTAL KVAR # ABSORBING/GENERATING	Displays total kVAR, absorbing or generating.
	L1 KVAR # ABSORBING/GENERATING	Displays L1 kVAR, absorbing or generating.
	L2 KVAR # ABSORBING/GENERATING	Displays L2 kVAR, absorbing or generating.
	L3 KVAR # ABSORBING/GENERATING	Displays L3 kVAR, absorbing or generating. (3 ph. only)
	POWER KVAR →	Returns the user to power kVAR heading.
	POWER KVA →	Displays the power kVA heading.
	TOTAL KVA #	Displays total kVA.
	L1 KVA #	Displays L1 kVA.
	L2 KVA #	Displays L2 kVA.















Menu 1—Generator Monitoring (Three-Phase Connections), continued

Menu 1 Displays with Key Entries

Key Entry	Display	Description
	L3 KVA #	Displays L3 kVA.
	POWER kVA →	Returns the user to power kVA heading.

Menu 1—Generator Monitoring (Single-Phase Connections)

Menu 1 Displays with Key Entries

Key Entry	Display	Description
	ENTER MENU NO. 1-15	Input a menu number.
	MAIN MENU NUMBER 1	Press the Enter key.
	MENU 1 GENERATOR MONITORING	Displays the menu number and name.
	VOLTS & AMPS →	Displays the volts and amps heading.
	L1-L2 VOLTS # L1 AMPS #	Displays L1 and L2 volts and L1 amps.
	L1-L2 VOLTS # L2 AMPS #	Displays L1 and L2 volts and L2 amps.
	L1-L0 VOLTS # L1 AMPS #	Displays L1-L0 volts and L1 amps.
	L2-L0 VOLTS # L2 AMPS #	Displays L2 and L0 volts and L2 amps.
	FREQUENCY # HZ	Displays the frequency.
	MENU 1 GENERATOR MONITORING	Returns the user to the menu number and name.
	VOLTS & AMPS →	Returns the user to volts and amps heading.
	V & A SUMMARY →	Displays the volts and amps summary heading.
	V L1-L2 L1-L0 L2-L0 # # #	Displays L1-L2, L1-L0, and L2-L0 volts.
	A L1 L2 # #	Displays L1 and L2 amps.
	V & A SUMMARY →	Returns the user to the volts and amps summary heading.

Menu 1—Generator Monitoring (Single-Phase Connections), continued

Menu 1 Displays with Key Entries

Key Entry	Display	Description
	POWER KW →	Displays the power kilowatt heading.
	TOTAL KW # PF # LEADING/LAGGING	Displays total kilowatts and leading or lagging power factor.
	L1 KW # PF # LEADING/LAGGING	Displays total L1 kilowatts and leading or lagging power factor.
	L2 KW # PF # LEADING/LAGGING	Displays total L2 kilowatts and leading or lagging power factor.
	TOTAL KW # % OF RATED KW #	Displays the total kW and percent of rated kilowatts.
	POWER KW →	Returns the user to the power kilowatt heading.
	POWER KVAR →	Displays the power kVAR heading.
	TOTAL KVAR # ABSORBING/GENERATING	Displays total kVAR, absorbing or generating.
	L1 KVAR # ABSORBING/GENERATING	Displays L1 kVAR, absorbing or generating.
	L2 KVAR # ABSORBING/GENERATING	Displays L2 kVAR, absorbing or generating.
	POWER KVAR →	Returns the user to power kVAR heading.
	POWER KVA →	Displays the power kVA heading.
	TOTAL KVA #	Displays total kVA.
	L1 KVA #	Displays L1 kVA.
	L2 KVA #	Displays L2 kVA.
	POWER kVA →	Returns the user to power kVA heading.

2.9.2 Menu 2—Engine Monitoring













Menu 2 provides engine operating data including oil pressure and temperature, coolant temperature, fuel pressure and temperature, engine rpm, and battery voltage. Menu 2 also displays engine warning and shutdown setpoints and engine warmed-up and cooled-down temperature setpoints.

The detailed engine monitoring functions appear only for DDEC (DDC/MTU), JDEC (John Deere), EMS2 (Volvo), EDC3 (Volvo), or MDEC/ADEC (DDC/MTU)-equipped engines.

Note: A right arrow from any submenu moves to the next submenu header.

Menu 2—Engine Monitoring Menu 2 Displays with Key Entries

Note: This menu is for monitoring only; no adjustments or user settings can be entered.

Key Entry	Display	Description
	ENTER MENU NO. 1-15	Input a menu number.
	MAIN MENU NUMBER 2	Press the Enter key.
	MENU 2 ENGINE MONITORING	Displays the menu number and name.
	ENGINE MONITORING → BASIC	Displays the basic engine monitoring heading.
	OIL PRESSURE # PSI COOLANT TEMP # F	Displays the oil pressure and coolant temperature.
	INTAKE AIR # F OIL TEMP (Waukesha) # F	Displays the intake air and oil temperature (Waukesha-powered models only)
	ENGINE RPM # LOCAL BATT VDC #	Displays the engine rpm and local battery VDC.
	HCT WARN # F HCT SDOWN # F	Displays the high coolant temperature warning and shutdown setpoints.
	LOP WARN # PSI LOP SDOWN # PSI	Displays the low oil pressure warning and shutdown setpoints.
	ENGINE WARMED UP # F	Displays the engine warmed up temperature setpoint.
	ENGINE COOLED DOWN # F	Displays the engine cooled down temperature setpoint.
	MENU 2 ENGINE MONITORING	Returns the user to the menu number and name.
	ENGINE MONITORING → BASIC	Returns the user to basic engine monitoring heading.







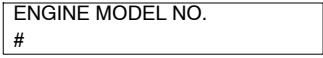

Menu 2—Engine Monitoring, continued

Menu 2 Displays with Key Entries

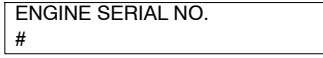
Key Entry	Display	Description
(DDEC/JDEC/EMS2/EDC3-Equipped Engines only)		
	ENGINE MONITORING DETAILED →	Displays the detailed engine monitoring heading. Note: The detailed engine monitoring feature requires a DDEC/JDEC/EMS2/EDC3-equipped engine.
	ENGINE FUEL →	Displays the engine fuel subheading.
	FUEL PRES # PSI FUEL TEMP # F	Displays the fuel pressure and fuel temperature.
	CHR AIR PRESS # PSI CHR AIR TEMP # F	Displays the charge air pressure and temperature.
	FUEL RATE # GPH	Displays the fuel rate per hour.
	USED LAST RUN # GAL	Displays the amount of fuel used during the last run.
	ENGINE MONITORING DETAILED →	Returns the user to the detailed engine monitoring heading.
	ENGINE FUEL →	Displays the engine fuel subheading.
	ENGINE COOLANT →	Displays the engine coolant subheading.
	COOLANT PRES # PSI COOLANT TEMP # F	Displays the coolant pressure and coolant temperature.
	COOLANT LEVEL #%	Displays the coolant level as a percent of full capacity.
	ENGINE COOLANT →	Returns the user to engine coolant subheading.
	ENGINE OIL →	Displays the engine oil subheading.
	OIL PRES # PSI OIL TEMP # F	Displays the oil pressure and oil temperature.
	OIL LEVEL #% CRANKCASE PRES # PSI	Displays the oil level as a percent of full capacity and crankcase pressure.
	ENGINE OIL →	Returns the user to engine oil subheading.
	ENGINE MISC →	Displays the miscellaneous engine subheading.
	ECM BATT VDC # AMBIENT TEMP # F	Displays the engine ECM battery VDC and ambient temperature.

Menu 2—Engine Monitoring, continued

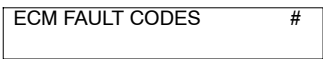
Menu 2 Displays with Key Entries

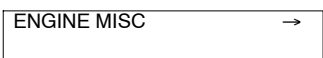
Key Entry	Display	Description
(DDEC/JDEC/EMS2/EDC3-Equipped Engines only, continued)		
		Displays the engine model number.
		Displays the engine serial number.
		Displays the unit number and ECM serial number.
		Displays the ECM fault codes.
		Returns the user to the miscellaneous engine subheading.

Menu 2—Engine Monitoring, continued

Menu 2 Displays with Key Entries

Key Entry	Display	Description
(MDEC-Equipped Engines only)		
	ENGINE MONITORING DETAILED →	Displays the detailed engine monitoring heading. Note: The detailed engine monitoring feature requires a DDC/MTU MDEC/ADEC-equipped engine.
	ENGINE FUEL →	Displays the engine fuel subheading.
	FUEL PRES # PSI FUEL TEMP # F	Displays the fuel pressure and fuel temperature.
	CHG AIR PRESSURE # PSI CHG AIR TEMP # F	Displays the turbocharger air pressure and temperature.
	FUEL RATE * # GPH	Displays the fuel rate per hour.
	DAILY FUEL USED * # GAL	Displays the amount of fuel used during the last 24 hours.
	TOTAL FUEL USED * # GAL	Displays the amount of fuel used since the last reset.
	ENGINE MONITORING DETAILED →	Returns the user to the detailed engine monitoring heading.
	ENGINE FUEL →	Displays the engine fuel subheading.
	ENGINE OIL →	Displays the engine oil subheading.
	OIL PRES # PSI OIL TEMP # F	Displays the oil pressure and oil temperature.
	ENGINE OIL →	Returns the user to engine oil subheading.
	ENGINE MISC →	Displays the miscellaneous engine subheading.
	ECU SUPPLY VDC # AMBIENT TEMP # F	Displays the engine ECU supply VDC and ambient temperature.
	ECU HOURS #	Displays the ECU operating hours.
	ECU FAULT CODES #	Displays the ECU fault codes.
	ENGINE MISC →	Returns the user to the miscellaneous engine subheading.

* While these menu displays do appear on the 550 controller, the engine ECM is not currently set up to provide this data.

2.9.3 Menu 3—Analog Monitoring

Menu 3 provides the battery voltage and up to 7 user-defined analog monitoring items dependent upon the generator system.

The *User Defined Desc* display refers to a description entered into the controller using the PC software. This description remains as the display for future review until changed by the PC software user. The display has 20 characters maximum.

Analog Voltage Adjust. When the analog voltage adjust option is enabled (see Menu 11), analog input 7 is predefined as voltage adjust. The voltage of this input will define the adjustment from the setting in Menu 11, Voltage Regulator. The normal analog input range of 0.5 to 4.5 corresponds to a $\pm 10\%$ of system voltage. The

midpoint 2.5 volts corresponds to 0 volts offset. If there is no connection at analog input 7, no voltage adjust is recognized.

Note: If the analog display shows O/R (out of range), no input is connected.













Note: Some data require entry using a PC in the Remote Programming mode. See the monitor software operation manual for details.

Note: See **Figure 2-8** in User Inputs for factory reserved inputs which are not user selectable.

Note: This menu is for monitoring only; no adjustments or user settings can be entered.











Menu 3—Analog Monitoring (ECM Engines)

Menu 3 Displays with Key Entries

Key Entry	Display	Description
	ENTER MENU NO. 1-15	Input a menu number.
	MAIN MENU NUMBER 3	Press the Enter key.
	MENU 3 ANALOG MONITORING	Displays the menu number and name.
	LOCAL BATT VDC #	Displays the local battery VDC.
	ANALOG 01 (USER DEFINED DESC) #	Displays analog 01 and the user-defined description.
	ANALOG 02 (USER DEFINED DESC) #	Displays analog 02 and the user defined description.
	ANALOG 03 (USER DEFINED DESC) #	Displays analog 03 and the user-defined description.
	ANALOG 04 (USER DEFINED DESC) #	Displays analog 04 and the user-defined description.
	ANALOG 05 (USER DEFINED DESC) #	Displays analog 05 and the user-defined description.
	ANALOG 06 (USER DEFINED DESC) #	Displays analog 06 end the user-defined description.
	ANALOG 07 (USER DEFINED DESC) #	Displays analog 07 and the user-defined description.
	OR	
	ANALOG 07 # ANALOG VOLT ADJUST	Displays analog 07 voltage adjustment VDC value when analog voltage adjust is enabled.
	ANALOG MONITORING MENU 3	Returns user to analog monitoring heading. Note: Enter data using a PC in the Remote Programming Mode.









Menu 3—Analog Monitoring (Non-ECM Engines)

Menu 3 Displays with Key Entries

Key Entry	Display	Description
	ENTER MENU NO. 1-15	Input a menu number.
	MAIN MENU NUMBER 3	Press the Enter key.
	MENU 3 ANALOG MONITORING	Displays the menu number and name.
	LOCAL BATT VDC #	Displays the local battery VDC.
	ANALOG 03 # (USER DEFINED DESC)	Displays analog 03 and the user-defined description.
	ANALOG 04 # (USER DEFINED DESC)	Displays analog 04 and the user-defined description.
	ANALOG 05 # (USER DEFINED DESC)	Displays analog 05 and the user-defined description.
	ANALOG 06 # (USER DEFINED DESC)	Displays analog 06 end the user-defined description.
	ANALOG 07 # (USER DEFINED DESC)	Displays analog 07 and the user-defined description.
	OR ANALOG 07 # ANALOG VOLT ADJUST	Displays analog 07 voltage adjustment VDC value when this option is enabled. Note: This function may be overridden by changing the description using the optional Monitor III software or by disabling in Menu 11.
	ANALOG MONITORING MENU 3	Returns user to analog monitoring heading. Note: Enter data using a PC in the Remote Programming Mode.

Menu 3—Analog Monitoring (Waukesha Engines)

Menu 3 Displays with Key Entries

Key Entry	Display	Description
	ENTER MENU NO. 1-15	Input a menu number.
	MAIN MENU NUMBER 3	Press the Enter key.
	MENU 3 ANALOG MONITORING	Displays the menu number and name.
	LOCAL BATT VDC #	Displays the local battery VDC.
	ANALOG 05 # (USER DEFINED DESC)	Displays analog 05 and the user-defined description.
	ANALOG 06 # (USER DEFINED DESC)	Displays analog 06 and the user-defined description.
	ANALOG 07 # (USER DEFINED DESC)	Displays analog 07 and the user-defined description.
OR		
	ANALOG 07 # ANALOG VOLT ADJUST	Displays analog 07 voltage adjustment VDC value when this option is enabled. Note: This function may be overridden by changing the description using the optional Monitor III software or by disabling in Menu 11.
	ANALOG MONITORING MENU 3	Returns user to analog monitoring heading. Note: Enter data using a PC in the Remote Programming Mode.

2.9.4 Menu 4—Operational Records

Menu 4 provides the generator set operational records including the operating start date, last logged maintenance, total run time loaded and unloaded, run time since the last maintenance, number of starts, and number of running days.

Run Time Feature. This menu provides the ability to run the generator set for a designated time. After the run time elapses, the generator set shuts down and functions in the standby mode. The generator set controller does not provide weekly scheduled exercise periods.













Generator set connected to an automatic transfer switch. Should a utility power failure occur while the unit is in the run time mode, the controller bypasses the run time mode and functions in the standby (backup) mode. If the utility power returns, the generator set continues to run for the duration of the run time period if not timed out.

Note: Press the STOP PROG RUN key to stop the generator set when in the run time mode, if necessary.

After performing maintenance, enter yes to reset records reflecting the current day. The user must enable the programming mode to edit the display.

Menu 4—Operational Records

Menu 4 Displays with Key Entries

Key Entry	Display	Description
	ENTER MENU NO. 1-15	Input a menu number.
	MAIN MENU NUMBER 4	Press the Enter key.
	MENU 4 OPERATIONAL RECORDS	Displays the menu number and name.
	FACTORY TEST DATE ##-##-##	Displays the factory test date (day-month-year).
	TOTAL RUN TIME HRS #	Displays the total run time (hours:minutes).
	TOTAL RUN TIME LOADED HRS #	Displays the total run time for loaded hours.
	TOTAL RUN TIME UNLOADED HRS #	Displays the total run time for unloaded hours.
	TOTAL RUN TIME KW HRS #	Displays the total run time in kW hours.
	NO. OF STARTS #	Displays the number of engine starts.
	ENGINE START? Y/N→ COUNTDOWN ##.##	Displays the start and countdown subheading.
	RUN TIME HR:MN→ ??:??	Displays the run time (hours:minutes) feature. When required, use the numeric keys to enter the selected run time (hours:minutes) and press the Enter key.
	RUN TIME HR:MN→ ##.##	Confirms entry and displays the selected run time (hours:minutes). The generator set will start after activation. Note: Activate the generator set run time feature by pressing the Yes and Enter keys. See the following steps.
	ENGINE START? Y/N→ COUNTDOWN ##.##	Returns the user to the start and countdown subheading. Enter Yes to start the generator set.

Menu 4—Operational Records, continued

Menu 4 Displays with Key Entries

Key Entry	Display	Description
	ENGINE START? YES→ COUNTDOWN ##:##	Press the Enter key.
	RUN TIME HR:MN→ ##:##	Confirms the entry. The generator set will begin cranking and run based on the run time (hours:minutes) period and all previously established time (hours:minutes) delays from Menu 8—Time Delays. Note: Press the STOP PROG RUN key to stop the generator set when in the run time mode, if necessary.
	RECORDS MAINT →	Displays the records maintenance subheading.
	RESET RECORDS? →	Displays the reset records option. After performing maintenance or when required, enter Yes to reset.
	RESET RECORDS? YES→	Enter Yes to reset to the current date and press the Enter key.
	RESET RECORDS? YES→	Confirms the entry.
	RECORDS MAINT →	Returns the user to records maintenance subheading.
	RUN TIME SINCE MAINT TOTAL HRS #	Displays the run time since the last maintenance with total hours.
	RUN TIME SINCE MAINT LOADED HRS #	Displays the run time since last the maintenance with loaded hours.
	RUN TIME SINCE MAINT UNLOADED HRS #	Displays the run time since the last maintenance with unloaded hours.
	RUN TIME SINCE MAINT KW HRS #	Displays the run time since the last maintenance in kW hours.
	OPERATING DAYS # LAST MAINT ##-##-##	Displays the operating days since the last maintenance.
	NO. OF STARTS # LAST MAINT ##-##-##	Displays the number of starts since the last maintenance date (day-month-year).
	LAST START ##:## AM/PM DATE ##-##-##	Displays last the start time (hours:minutes) and date (day-month-year).
	LENGTH OF RUN (UN)LOADED HRS #	Displays the length of last run in (un)loaded hours.
	MENU 4 OPERATIONAL RECORDS	Returns the user to the operational records heading.







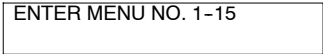

2.9.5 Menu 5—Event History

Menu 5 stores and displays the times and dates of up to 100 stored status, warning, and shutdown events. After the first 100 events, each additional new event replaces the oldest event. See Menu 10—Output Setup for a list of possible events.

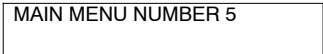
Note: This menu is for monitoring only; no adjustments or user settings can be entered.

Menu 5—Event History

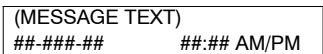
Menu 5 Displays with Key Entries

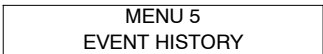
Key Entry	Display	Description
		Input a menu number.
		Press the Enter key.
		Displays the menu number and name.
		Displays the message text, date (day-month-year) and time (hours:minutes). Scroll through up to 100 stored events. See Section 2.4.5, System Warning Lamp, for fault descriptions.
		Returns the user to event history heading.

2.9.6 Menu 6—Time and Date









Menu 6 sets the clock time and date and internal calendar. The controller uses set time for determining the exercise run time and event records. The time and date are valid only if the controller power (starting battery) remains connected.

The user must enable the programming mode to edit the display.

Note: A change to the time/date is recorded as a system event. The time/date reset and other events are viewable (up to 100 events). For events that occurred prior to a date change, use the previous date as the reference point for determining the event's actual date.

Menu 6—Time and Date

Menu 6 Displays with Key Entries

Key Entry	Display	Description
	ENTER MENU NO. 1-15	Input a menu number.
	MAIN MENU NUMBER 6	Press the Enter key.
	MENU 6 TIME AND DATE	Displays the menu number and name.
	DAY OF WEEK ##-##-## ###:## AM/PM	Displays the day of the week, date (day-month-year), and time (hours:minutes).
	TIME ?:?:? AM/PM	Displays the time (hours:minutes) of day entry. When required, use the numeric and am/pm keys to set the time (hours:minutes) of day and press the Enter key.
	DAY OF WEEK ##-##-## ###:## AM/PM	Displays the corrected time (hours:minutes) of day.
	DATE ??-??-??	Displays the date (day-month-year) entry. When required, use the numeric keys to set the day of the month.
	AND	
	DATE ??-??-??	Use the Menu Right → key to select the month .
	AND	
	DATE ??-??-??	Use the numeric keys to set the two-digit year and press the Enter key.
	AND	
	DAY OF WEEK ##-##-## ###:## AM/PM	Displays the corrected date (day- month-year).

2.9.7 Menu 7—Generator System

Menu 7 contains the factory-preset generator set voltage and frequency data. Enter the corresponding data if the generator set requires voltage reconnection and/or frequency adjustment. It is imperative that the user enter the correct data because these settings trigger all related shutdowns.

See Section 2.6.3, Request and Error Messages, for error display messages and explanations while navigating the menus.

The user must enable the programming mode to edit the display.

Note A: Some alternators have limited voltage and frequency configurations. Inappropriate voltage or frequency entries will cause a RANGE ERROR message.

Note: The user defines the data shown in Menu 7. It is NOT data measured by the controller and associated sensing devices. The user defines these values for purposes of calibrating the control.

Note: Press the Menu Right → key prior to entering decimal values where necessary.

Note: The variable speed governor (VSG) display provides the ability to parallel the generator set.

Note: For Version 3.01 and higher, the **Adjusted RPM** menu will display the adjusted engine speed from either an analog input or the keypad. When **Digital VSG** is selected, the user can also enter a new adjusted RPM in the **Adjusted RPM** menu.

Note: For Version 3.01 and higher, **Speed Adjust Select** allows the user to select the type of adjustment for engine speed on Volvo, GM, Doosan and KDI engines. The user can select **Analog VSG** (where a potentiometer or external control device on analog input 6 is used to change the desired speed) or **Digital VSG** (where the user can enter a value on the key pad through the Adjusted RPM menu).

Menu 7—Generator System

Menu 7 Displays with Key Entries

Key Entry	Display	Description
RESET MENU	ENTER MENU NO. 1-15	Input a menu number.
7 YES	MAIN MENU NUMBER 7	Press the Enter key.
ENTER ↵	MENU 7 GENERATOR SYSTEM	Displays the menu number and name.
MENU ▼	OPERATING MODE → (see note) YES	Displays the operating mode selection. Note: The display sample may differ depending upon previous entries. The previously selected operating mode appears first, either standby or prime power.
MENU ▶	OPERATING MODE → STANDBY NO	Displays the optional operating mode selection. When required, enter YES for standby operating mode. Note: This display indicates the <i>generator set application</i> .
7 YES	OPERATING MODE → STANDBY YES	Enter YES to change the operating mode selection to standby and press the Enter key.
ENTER ↵	OPERATING MODE → STANDBY YES	Confirms the entry.
OR		
MENU ▶	OPERATING MODE → PRIME POWER NO	Displays the optional operating mode selection. When required, enter YES for the prime power operating mode. Note: This display indicates the <i>generator set application</i> .
7 YES	OPERATING MODE → PRIME POWER YES	Enter YES to change the operating mode selection to prime power and press the Enter key.
ENTER ↵	OPERATING MODE → PRIME POWER YES	Confirms the entry.
MENU ▼	SYSTEM VOLTAGE LINE-LINE ?	Displays the line-to-line system voltage as entered data. When required, use the numeric keys to set new value. Press the Enter key.
ENTER ↵	SYSTEM VOLTAGE LINE-LINE #	Displays the corrected line-to-line system voltage. See NOTE A.
MENU ▼	SYSTEM FREQ # HZ	Displays the system frequency as entered data. When required, use the numeric keys to set the new value. Press the Enter key.

















Menu 7—Generator System, continued

Menu 7 Displays with Key Entries

Key Entry	Display	Description
	SYSTEM FREQ # HZ	Displays the corrected system frequency. See NOTE A.
	PHASE (see note) YES	Displays the phase configuration selection. Note: The display sample may differ depending upon previous entries. The user-selected phase appears first, either wye, delta, or single phase.
	PHASE 3 PHASE DELTA NO	Displays the optional phase configuration selection. When required, use the YES key to choose the delta phase configuration.
	PHASE 3 PHASE DELTA YES	Enter YES to change the phase configuration to a delta phase configuration and press the Enter key.
	PHASE 3 PHASE DELTA YES	Confirms the entry. See NOTE A.
OR		
	PHASE 3 PHASE WYE NO	Displays the optional phase configuration selection. When required, use the YES key to choose the wye phase configuration.
	PHASE 3 PHASE WYE YES	Enter YES to change the phase configuration to a wye phase configuration and press the Enter key.
	PHASE 3 PHASE WYE YES	Confirms the entry. See NOTE A.
OR		
	PHASE SINGLE-PHASE NO	Displays the optional phase configuration selection. When required, use the YES key to choose the single-phase configuration.
	PHASE SINGLE-PHASE YES	Enter YES to change the phase configuration to a single-phase configuration and press the Enter key.
	PHASE SINGLE-PHASE YES	Confirms the entry. See NOTE A.
	KW RATING ?	Displays the generator set kW rating as entered data. When required, use the numeric keys to set the new value. Press the Enter key.
	KW RATING #	Displays the corrected system kilowatt rating.
	RATED CURRENT #	Displays the generator set rated current as entered data. Note: This is a read-only display.
	LOAD SHED OUTPUT ?% # KW	Displays the load shed output setting. When required, use the numeric keys to set the new value. Press the Enter key. See Menu 10, Output Setup for Group B User-Defined Systems Events
	LOAD SHED OUTPUT #% # KW	Displays the corrected load shed output setting.
	TIME DELAY MIN:SEC ?:??	Displays the load shed time (minutes:seconds) delay setting. When required, use the numeric keys to set the new value. Press the Enter key.
	TIME DELAY MIN:SEC ##:##	Displays the corrected load shed time (minutes:seconds) delay setting.
	LOAD SHED OUTPUT #% # KW	Returns the user to the load shed output setting.

Menu 7—Generator System, continued

Menu 7 Displays with Key Entries

Key Entry	Display	Description
	OVERVOLTAGE → ?% # VAC	Displays the overvoltage setting. When required, use the numeric keys to set the new value. Press the Enter key.
	OVERVOLTAGE → #% # VAC	Displays the corrected overvoltage setting.
	TIME DELAY MIN:SEC → ??:??	Displays the overvoltage time (minutes:seconds) delay setting. When required, use the numeric keys to set the new value. Press the Enter key.
	TIME DELAY MIN:SEC → ##:##	Displays the corrected overvoltage time (minutes:seconds) delay setting.
	OVERVOLTAGE → #% # VAC	Returns the user to the overvoltage setting.
<hr/>		
	UNDERVOLTAGE → ?% # VAC	Displays the undervoltage setting. When required, use the numeric keys to set the new value. Press the Enter key.
	UNDERVOLTAGE → #% # VAC	Displays the corrected undervoltage setting.
	TIME DELAY MIN:SEC → ??:??	Displays the undervoltage time (minutes:seconds) delay setting. When required, use the numeric keys to set the new value. Press the Enter key.
	TIME DELAY MIN:SEC → ##:##	Displays the corrected overvoltage time (minutes:seconds) delay setting.
	UNDERVOLTAGE → #% # VAC	Returns the user to the undervoltage setting.
<hr/>		
	OVERFREQUENCY → ?% # HZ	Displays the overfrequency setting. When required, use the numeric keys to set the new value. Press the Enter key.
	OVERFREQUENCY → #% # HZ	Displays the corrected overfrequency setting.
	UNDERFREQUENCY → ?% # HZ	Displays the underfrequency setting. When required, use the numeric keys to set the new value. Press the Enter key.
	UNDERFREQUENCY → #% # HZ	Displays the corrected underfrequency setting.
	OVERSPEED → ? HZ # RPM	Displays the overspeed setting. When required, use the numeric keys to set the new value. Press the Enter key.
	OVERSPEED → # HZ # RPM	Displays the corrected overspeed setting.

Menu 7—Generator System, continued

Menu 7 Displays with Key Entries

Key Entry	Display	Description
MENU ↓	BATTERY VOLTAGE (see note) → YES	Displays the battery voltage selection. Note: The display sample may differ depending upon previous entries. The user-selected battery voltage appears first, either 12 VDC or 24 VDC.
MENU →	BATTERY VOLTAGE 12 VDC → NO	Displays the 12 VDC battery voltage selection. When required, use the YES key to choose the 12 VDC battery voltage.
7 YES	BATTERY VOLTAGE 12 VDC → YES	Enter YES to change the battery voltage to 12 VDC and press the Enter key.
ENTER ↵	BATTERY VOLTAGE 12 VDC → YES	Confirms the entry.
OR		
MENU →	BATTERY VOLTAGE 24 VDC → NO	Displays the 24 VDC battery voltage selection. When required, use the YES key to choose the 24 VDC battery voltage.
7 YES	BATTERY VOLTAGE 24 VDC → YES	Enter YES to change the battery voltage to 24 VDC and press the Enter key.
ENTER ↵	BATTERY VOLTAGE 24 VDC → YES	Confirms the entry.
MENU ↓	LOW BATTERY VOLTAGE ?.? VDC	Displays the low battery voltage setting. When required, use the numeric keys to set the new value. Press the Menu Right → key prior to entering the decimal value.
AND		
MENU →	LOW BATTERY VOLTAGE ?.? VDC	Use the numeric keys to enter the <i>decimal</i> value. Press the Enter key.
ENTER ↵	LOW BATTERY VOLTAGE ## VDC	Displays the corrected low battery voltage setting.
MENU ↓	HIGH BATTERY VOLTAGE ?.? VDC	Displays the high battery voltage setting. When required, use the numeric keys to set the new value. Press the Menu Right → key prior to entering the decimal value.
AND		
MENU →	HIGH BATTERY VOLTAGE ?.? VDC	Use the numeric keys to enter the <i>decimal</i> value. Press the Enter key.
ENTER ↵	HIGH BATTERY VOLTAGE ## VDC	Displays the corrected high battery voltage setting.
MENU ↓	BLOCK HEATER ON # F	Displays the block heater energize temperature setting. When required, use the numeric keys to set the new value. Applies to DDC/MTU engines with MDEC/ADEC only.
AND		
MENU →	BLOCK HEATER ON ? F	Use the numeric keys to enter the <i>decimal</i> value. Press the Enter key.
ENTER ↵	BLOCK HEATER ON # F	Displays the corrected block heater energize temperature setting.
MENU ↓	BLOCK HEATER OFF # F	Displays the block heater deenergize temperature setting. When required, use the numeric keys to set the new value. Applies to Detroit Diesel engines with MDEC/ADEC engine controls only.
AND		
MENU →	BLOCK HEATER OFF ? F	Use the numeric keys to enter the <i>decimal</i> value. Press the Enter key.
ENTER ↵	BLOCK HEATER OFF # F	Displays the corrected block heater deenergize temperature setting.

Menu 7—Generator System, continued

Menu 7 Displays with Key Entries

Key Entry	Display	Description
MENU ▼	ENABLE VSG YES/NO	Displays the variable speed governor (VSG) yes or no selection for paralleling applications. When required, use the numeric keys to set the new value. Applies to DDC/MTU MDEC/ADEC engine only.
7 YES	ENABLE VSG NO ENABLE VSG YES	Entering YES enables the VSG function.
ENTER ↵	ENABLE VSG YES	Confirms the entry..
8 NO	OR ENABLE VSG YES ENABLE VSG NO	Entering NO disables the VSG function.
ENTER ↵	ENABLE VSG NO	Confirms the entry..
MENU ▼	ENABLE DSC YES/NO	Displays the digital speed control (DSC) yes or no selection for paralleling applications. When required, use the numeric keys to set the new value. Applies to DDC/MTU MDEC/ADEC engine only.
7 YES	ENABLE DSC NO ENABLE DSC YES	Entering YES enables the DSC function.
ENTER ↵	ENABLE DSC YES	Confirms the entry..
8 NO	OR ENABLE DSC YES ENABLE DSC NO	Entering NO disables the DSC function.
ENTER ↵	ENABLE DSC NO	Confirms the entry..

Menu 7—Generator System, continued

Menu 7 Displays with Key Entries

Key Entry	Display	Description
	METRIC UNITS Y/N	Displays the metric units selection.
<hr style="border-top: 1px dashed black;"/>		
	METRIC UNITS NO	Enter YES to change to metric displays and press the Enter key.
	METRIC UNITS YES	
	METRIC UNITS YES	Confirms the entry.
<hr style="border-top: 1px dashed black;"/>		
OR		
	METRIC UNITS YES	Enter NO to change to English displays and press the Enter key.
	METRIC UNITS NO	
	METRIC UNITS NO	Confirms the entry.
<hr style="border-top: 1px dashed black;"/>		
	SET NFPA-110 DEFAULTS Y/N	Displays the NFPA 110 default yes or no selection. Note: See Menu 10—Output Setup, Overview for a list of the NFPA-110 faults.
<hr style="border-top: 1px dashed black;"/>		
	SET NFPA-110 DEFAULTS NO	Enter YES to select the NFPA 110 default selection and press the Enter key.
	SET NFPA-110 DEFAULTS YES	
	SET NFPA-110 DEFAULTS YES	Confirms the entry.
<hr style="border-top: 1px dashed black;"/>		
OR		
	SET NFPA-110 DEFAULTS YES	Enter NO to deselect the NFPA 110 default selection and press the Enter key.
	SET NFPA-110 DEFAULTS NO	
	SET NFPA-110 DEFAULTS NO	Confirms the entry.
<hr style="border-top: 1px dashed black;"/>		
	MENU 7 GENERATOR SYSTEM	Returns the user to the generator system heading.

2.9.8 Menu 8—Time Delays

Menu 8 displays the various time delays for cyclic cranking and other engine-related starting and shutdown features.















The user must enable the programming mode to edit the display.

Cooldown Temperature Override. This feature allows the user to bypass (override) the temperature-based cooldown. When this feature is enabled, the engine will run in cooldown mode for the entire time defined as TIME DELAY ENG COOLDOWN, regardless of engine temperature.

If the Cooldown Temperature Override is not enabled, the unit will cease to run when the engine temperature falls below the ENGINE COOLED DOWN temperature (shown in Menu 2).

Engine cooldown and this cooldown temperature override feature apply to remote shutdown when the master switch is in the AUTO position. No cooldown will occur when the master switch is moved to the OFF position.

Menu 8—Time Delays Menu 8 Displays with Key Entries

Key Entry	Display	Description
	ENTER MENU NO. 1-15	Input a menu number.
	MAIN MENU NUMBER 8	Press the Enter key.
	MENU 8 TIME DELAYS	Displays the menu number and name.
	TIME DELAY MIN:SEC ENGINE START ??:??	Displays the engine start time delay in minutes:seconds. When required, use the numeric keys to set the new value. Press the Enter key.
	TIME DELAY MIN:SEC ENGINE START ##:##	Displays the corrected engine start time (minutes:seconds) delay setting.
	TIME DELAY MIN:SEC STARTING AID ??:??	Displays the starting aid time delay in minutes:seconds. When required, use the numeric keys to set the new value. Press the Enter key.
	TIME DELAY MIN:SEC STARTING AID ##:##	Displays the corrected starting aid time (minutes:seconds) delay setting.
	TIME DELAY MIN:SEC CRANK ON ??:??	Displays the crank on time delay in minutes:seconds. When required, use the numeric keys to set the new value. Press the Enter key.
	TIME DELAY MIN:SEC CRANK ON ##:##	Displays the corrected crank on time (minutes:seconds) delay setting.
	TIME DELAY MIN:SEC CRANK PAUSE ??:??	Displays the crank pause time delay in minutes:seconds. When required, use the numeric keys to set the new value. Press the Enter key.
	TIME DELAY MIN:SEC CRANK PAUSE ##:##	Displays the corrected crank pause time (minutes:seconds) delay setting.
	TIME DELAY MIN:SEC ENG COOLDOWN ??:??	Displays the engine cooldown time delay in minutes:seconds. When required, use the numeric keys to set the new value. Press the Enter key.
	TIME DELAY MIN:SEC ENG COOLDOWN ##:##	Displays the corrected engine cooldown time (minutes:seconds) delay setting.
	COOLDOWN TEMPERATURE OVERRIDE Y/N	Displays the cooldown temperature override. When required, Press the Yes key to override the temperature based cooldown or press the No key to enable temperature based cooldown.

Menu 8—Time Delays, continued

Menu 8 Displays with Key Entries

Key Entry	Display	Description
	COOLDOWN TEMPERATURE OVERRIDE YES	Enter YES to select cooldown temperature override time delay and press the Enter key.
	COOLDOWN TEMPERATURE OVERRIDE Y/N	Confirms the entry.
	OVERCRANK SHUTDOWN CRANK CYCLES ?	Displays the engine crank cycles before overcrank shutdown. When required, use the numeric keys to set the new value. Press the Enter key.
	OVERCRANK SHUTDOWN CRANK CYCLES #	Displays the corrected engine crank cycles before overcrank shutdown setting.
	TIME DELAY MIN:SEC OVERVOLTAGE ??:??	Displays the overvoltage time delay in minutes:seconds. When required, use the numeric keys to set the new value. Press the Enter key.
	TIME DELAY MIN:SEC OVERVOLTAGE ##:##	Displays the corrected overvoltage time (minutes:seconds) delay setting.
	TIME DELAY MIN:SEC UNDERVOLTAGE ??:??	Displays the undervoltage time delay in minutes:seconds. When required, use the numeric keys to set the new value. Press the Enter key.
	TIME DELAY MIN:SEC UNDERVOLTAGE ##:##	Displays the corrected undervoltage time (minutes:seconds) delay setting.
	TIME DELAY MIN:SEC LOAD SHED KW ??:??	Displays the load shed time delay in minutes:seconds. When required, use the numeric keys to set the new value. Press the Enter key.
	TIME DELAY MIN:SEC LOAD SHED KW ##:##	Displays the corrected load shed time (minutes:seconds) delay setting.
	MENU 8 TIME DELAYS	Returns the user to the time delays heading.

2.9.9 Menu 9—Input Setup

Menu 9 provides the setup of user-defined digital and analog warning and shutdown inputs. These inputs provide a multitude of choices for configuring customized auxiliary inputs.

The user must enable the programming mode to edit the display.

Note: Press the down arrow to move to the start of the next input setup.

Note: The user must scale the analog input value in order to calculate the low/high warning and shutdown analog values based on a 0–5 VDC scale. See Menu 12, Calibration.

Note: If the ALARM ACTIVE message appears, the selected input has an active fault disabling the input. This prevents the enabled choice change from yes to no. The LED display indicates whether the fault is a warning or shutdown. Correct the fault condition before attempting the keypad entry.

Note: Some data requires entry by a PC in the Remote Programming mode. See the monitor software operation manual for details.

Digital and Analog Inputs. After the user selects the input, the setup requires entering the following choices or values: enabled (yes/no), inhibit time, and delay time.

Note: See **Figure 2-8** in User Inputs for factory reserved digital and analog inputs which are not user selectable.

- **Enabled.** This menu entry enables the input. The previous yes/no selection does not activate the input. **Digital inputs** have three tier groups: the selection group (25 total), the chosen group (up to 21 total), and the enabled group (up to 21 total based on the chosen group). **Analog inputs** have separate warning and shutdown enabled choices.
- **Inhibit Time Delay.** The inhibit time delay is the time period following crank disconnect during which the generator set stabilizes and the controller does not detect fault or status events. The inhibit time delay range is from 0 to 60 seconds.
- **Time Delay (Shutdown or Warning).** The time delay follows the inhibit time delay. The time delay is the time period between the controller fault or status event detection and the controller warning or shutdown lamp illumination. The delay prevents any nuisance alarms. The time delay range is from 0 to 60 seconds.

Digital Inputs. Items identified as *not user selectable* are included for specific applications. (Example: AFM SHUTDOWN is enabled with a Waukesha-powered model.) The user can not disable a digital input when identified as not user selectable.

Analog Inputs. View up to 7 user-defined analog inputs A01–A07.

Analog Input A06—Analog Speed Adjust (VSG). Analog Input A06 may be used for analog speed adjust when external control of engine speed is desired such as paralleling applications or closed transition ATS. To utilize this capability, “ANALOG VSG A06” must be selected from the Speed Adjust selection. Refer to 2.9.7, Menu 7 for Speed Adjust selection.

Note: For controller firmware versions prior to 3.4.3, analog input A06 must be calibrated. Refer to 2.9.12, Menu 12–Calibration.

Note: This feature is supported for Doosan, GM, Volvo, and KDI engines only.

Analog Input A07—Analog Voltage Adjust. Analog voltage adjust is a feature that the user may choose to enable. The input designated for use as Analog Voltage Adjust is analog input A07.

Enable Analog Voltage Adjust through Menu 11. Additionally, Monitor 2 or Monitor 3 may be used to enable Analog Voltage Adjust by entering the proper description (*Analog Volt Adjust*) for A07. When Analog Voltage Adjust is enabled, the description for A07 is *Analog Volt Adjust*. Changing the description using Monitor 2 or Monitor 3 disables the analog voltage adjust feature.

When Analog Voltage Adjust is enabled, no warning or shutdown may be enabled for A07.

Note: If the analog input A07 description does not match *Analog Volt Adjust*, input A07 will **not** function as the voltage adjust.

Identification and Descriptions. Descriptions for user inputs (auxiliary analog or auxiliary digital) may be entered using the Monitor III software accessory where the user determines the descriptions in upper and lower case.

Analog Input Values. The analog input selection typically requires entering four values: low warning, high warning, low shutdown, and high shutdown. The analog values and time delays affect how and when the controller reacts. See Figure 2-19. The user must set both the high and low levels so the unit will not inadvertently trigger the adjacent high or low value to cause a warning or shutdown fault.

Each analog input has the following nine features:

- One warning enabled and one shutdown enabled
- One inhibit time period
- One warning delay and one shutdown delay
- Two warning levels (high and low)
- Two shutdown levels (high and low)

Note: The user must scale the analog input value in order to calculate the low/high warning and shutdown values based on a 0–5 VDC scale. See Menu 12—Calibration.

Analog Values	Time after Crank Disconnect		
	Inhibit Time Period →	Time Delay Period →	Time Delay Complete
High shutdown value is above the high warning value	The controller <i>does not</i> view the analog input signal value	The controller <i>does</i> view the analog input signal value and the <i>time delay begins</i>	High shutdown function
High warning value is above the acceptable value			High warning function
Acceptable analog value			System ready status
Low warning value is below the acceptable value			Low warning function
Low shutdown value is below the low warning value			Low shutdown function

Figure 2-19 Analog Input Logistics

Battle Switch/Fault Shutdown Override Switch. The *battle* switch function forces the system to ignore normal fault shutdowns such as low oil pressure and high engine temperature. The battle switch does not override the emergency stop, overspeed, and overfrequency shutdowns. When the battle switch function is enabled the generator set continues to run regardless of shutdown signals where potential engine/generator damage can occur.

When this input is enabled the yellow warning lamp illuminates and stored warning/shutdown events that are ignored continue to log in Menu 5—Event History.

Idle Mode Active. The idle time is defined by the digital input time delay. Set the desired time in minutes:seconds, up to 10 minutes (600 seconds). If manual control of the idle mode is desired, an unlimited time can be entered as 9:99. The generator set will remain at idle speed as long as the input is active and the generator set master switch is in the AUTO position. See Section 6.1.6 for idle mode operation.

Shutdown Type A and Shutdown Type B. Choose **shutdown type A** for standard shutdowns where the red lamp illuminates and the alarm horn sounds. Choose **shutdown type B** for shutdowns where air damper indicator RDO-23 energizes for two seconds, the red lamp illuminates, and the alarm horn sounds.

Menu 9—Input Setup

Menu 9 Displays with Key Entries

Key Entry	Display	Description
	ENTER MENU NO. 1-15	Input a menu number.
	MAIN MENU NUMBER 9	Press the Enter key.
	MENU 9 INPUT SETUP	Displays the menu number and name.
	SETUP DIGITAL AUXILIARY INPUTS →	Displays the setup of digital auxiliary inputs heading.
	DIGITAL INPUT 01 (USER DEFINED DESC) →	Displays the digital input 01 with the user-defined description. Note: Press the down arrow to move to the start of the next input setup.
	DIGITAL INPUT 01 → (see Group A) YES/NO	Identifies the signal source for digital input 01. Use the menu down ↓ key to select the digital input.

Group A

The preprogrammed selections include the following list. See Appendix E for application and restrictions with specific engines.

WARNING	Y/N
SHUTDOWN TYPE A	Y/N
SHUTDOWN TYPE B	Y/N
VOLTAGE RAISE	Y/N
VOLTAGE LOWER	Y/N

Group A, continued

VAR PF MODE	Y/N
REMOTE SHUTDOWN	Y/N
REMOTE RESET	Y/N
AIR DAMPER	Y/N
LOW FUEL	Y/N
FIELD OVERVOLTAGE	Y/N
IDLE MODE ACTIVE	Y/N
BATTLE SWITCH	Y/N
GROUND FAULT	Y/N
BAT CHGR FAULT	Y/N
HIGH OIL TEMP	Y/N

Group A, continued

LOW COOLANT LEVEL	Y/N
LOW COOLANT TEMP	Y/N
BREAKER CLOSED	Y/N
ENABLE SYNCH	Y/N
AFM SHUTDOWN	Y/N
KNOCK SHUTDOWN	Y/N
DETON WARNING	Y/N
DETON SHUTDOWN	Y/N
LOW FUEL SHUTDOWN	Y/N

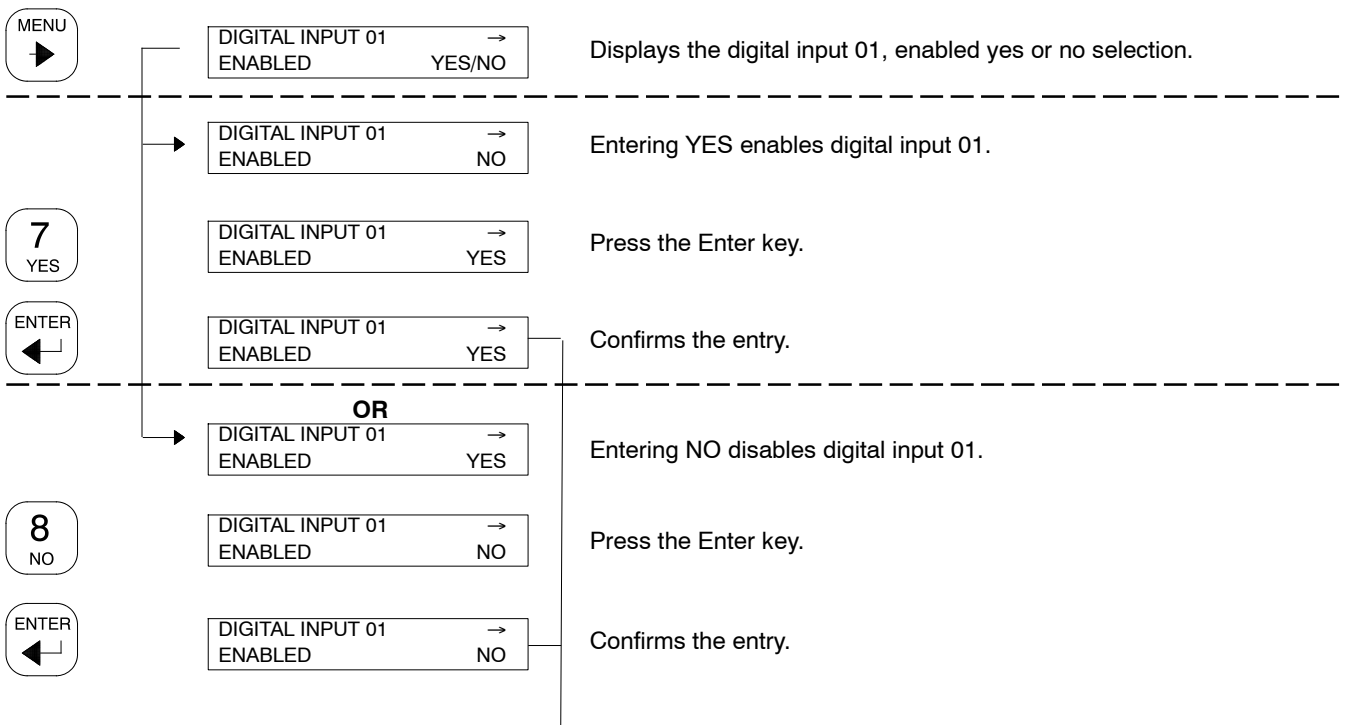

Menu 9—Input Setup, continued

Menu 9 Displays with Key Entries

Key Entry	Display	Description
	DIGITAL INPUT 01 INHIBIT TIME ?:??	Displays the digital input 01 inhibit time (minutes:seconds) setting. When required, use the numeric keys to set the new values. Press the Enter key.
	DIGITAL INPUT 01 INHIBIT TIME #:##	Displays the corrected inhibit time (minutes:seconds) setting.
	DIGITAL INPUT 01 DELAY TIME ?:??	Displays the digital input 01 delay time (minutes:seconds) setting. When required, use the numeric keys to set the new values. Press the Enter key.
	DIGITAL INPUT 01 DELAY TIME #:##	Displays the corrected delay time (minutes:seconds) setting.
	DIGITAL INPUT 01 (USER DEFINED DESC)	Returns the user to digital input 01.
	DIGITAL INPUT XX (USER DEFINED DESC)	Displays digital inputs 02 to 21. Note: Press the down arrow to scroll through additional digital auxiliary inputs or enter the input number. Note: Press the right arrow at each digital auxiliary input to enable the selection, inhibit time setting, and delay time setting. See Digital Input 01 instructions for complete procedure and Group A selections. See Figure 2-8 in User Inputs for factory reserved digital and analog inputs which are not user selectable.
	MENU 9 INPUT SETUP	Returns the user to the menu number and name.
	SETUP DIGITAL AUXILIARY INPUTS	Returns the user to setup digital auxiliary inputs.
	SETUP ANALOG AUXILIARY INPUTS	Displays the setup of analog auxiliary inputs heading.
	ANALOG INPUT 01 (USER DEFINED DESC)	Displays the analog input 01 with user-defined description. Note: ECM engines have inputs 01-07 and non-ECM engines have inputs 03-07. Waukesha engines have inputs 05-07. Note: Press the down arrow to move to the start of the next input setup.
	ANALOG INPUT 01 WARNING ENABLED Y/N	Displays the analog input 01, warning enabled yes or no selection.
	ANALOG INPUT 01 WARNING ENABLED NO	Entering YES enables the warning analog input 01.
	ANALOG INPUT 01 WARNING ENABLED YES	Press the Enter key.
	AND ANALOG INPUT 01 WARNING ENABLED YES	Confirms the entry.
	OR ANALOG INPUT 01 WARNING ENABLED YES	Entering NO disables the warning analog input 01.
	ANALOG INPUT 01 WARNING ENABLED NO	Press the Enter key.
	AND ANALOG INPUT 01 WARNING ENABLED NO	Confirms the entry.













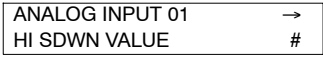

Menu 9—Input Setup, continued

Menu 9 Displays with Key Entries

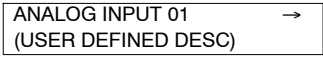
Key Entry	Display	Description
MENU ▶	ANALOG INPUT 01 SHUTDOWN ENABLED → Y/N	Displays the analog input 01, shutdown enabled selection.
<hr/>		
7 YES	ANALOG INPUT 01 SHUTDOWN ENABLED → NO	Entering YES enables the shutdown analog input 01.
ENTER ↵	ANALOG INPUT 01 SHUTDOWN ENABLED → YES	Press the Enter key.
AND		
ENTER ↵	ANALOG INPUT 01 SHUTDOWN ENABLED → YES	Confirms the entry.
<hr/>		
OR		
8 NO	ANALOG INPUT 01 SHUTDOWN ENABLED → YES	Entering NO disables the shutdown analog input 01.
ENTER ↵	ANALOG INPUT 01 SHUTDOWN ENABLED → NO	Press the Enter key.
AND		
ENTER ↵	ANALOG INPUT 01 SHUTDOWN ENABLED → NO	Confirms the entry.
<hr/>		
MENU ▶	ANALOG INPUT 01 INHIBIT TIME → ?:??	Displays the analog input 01, inhibit time (minutes:seconds) setting. When required, use the numeric keys to set the new values. Press the Enter key.
ENTER ↵	ANALOG INPUT 01 INHIBIT TIME → #:#	Displays the corrected inhibit time (minutes:seconds) setting.
MENU ▶	ANALOG INPUT 01 WARN DELAY TIME → ?:??	Displays the analog input 01, warning time (minutes:seconds) delay setting. When required, use the numeric keys to set the new values. Press the Enter key.
ENTER ↵	ANALOG INPUT 01 WARN DELAY TIME → #:#	Displays the corrected warning time (minutes:seconds) delay setting.
MENU ▶	ANALOG INPUT 01 SDWN DELAY TIME → ?:??	Displays the analog input 01, shutdown time (minutes:seconds) delay setting. When required, use the numeric keys to set the new values. Press the Enter key.
ENTER ↵	ANALOG INPUT 01 SDWN DELAY TIME → #:#	Displays the corrected shutdown time (minutes:seconds) delay setting.
MENU ▶	ANALOG INPUT 01 LO SDWN VALUE → ?	Displays the analog input 01, low shutdown value. When required, use the numeric keys to set the new values. Press the Enter key. Note: The user must scale the analog input value in order to calculate the low/high warning and shutdown values based on a 0–5 VDC scale. See Menu 12—Calibration.
ENTER ↵	ANALOG INPUT 01 LO SDWN VALUE → #	Displays the corrected low shutdown value.
MENU ▶	ANALOG INPUT 01 LO WARN VALUE → ?	Displays the analog input 01, low warning value. When required, use the numeric keys to set the new values. Press the Enter key. Note: The user must scale the analog input value in order to calculate the low/high warning and shutdown values based on a 0–5 VDC scale. See Menu 12—Calibration.
ENTER ↵	ANALOG INPUT 01 LO WARN VALUE → #	Displays the corrected low warning value.

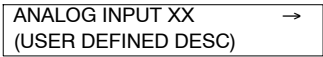
Menu 9—Input Setup, continued

Menu 9 Displays with Key Entries

Key Entry	Display	Description
		Displays the analog input 01, high warning value. When required, use the numeric keys to set the new values. Press the Enter key. Note: The user must scale the analog input value in order to calculate the low/high warning and shutdown values based on a 0-5 VDC scale. See Menu 12—Calibration.
		Displays the corrected high warning value.
		Displays the analog input 01, high shutdown value. When required, use the numeric keys to set the new values. Press the Enter key. Note: The user must scale the analog input value in order to calculate the low/high warning and shutdown values based on a 0-5 VDC scale. See Menu 12—Calibration.
		Displays the corrected high shutdown value.
		Returns the user to analog input 01.
		Displays analog inputs A02 to A07. Note: Press the down arrow to scroll through additional analog auxiliary inputs or enter the input number. Note: ECM engines have inputs A01-A07 and non-ECM engines have inputs A03-A07. Waukesha engines have inputs A05-A07. Note: Press the right arrow at each analog auxiliary input for the following selections and settings: Warning enabled Shutdown enabled Inhibit time Warning delay time Shutdown delay time Low shutdown value Low warning value High warning value High shutdown value
		See the Analog Input 01 instructions for the complete procedure. Returns the user to the setup analog auxiliary input heading.
		Returns the user to the setup digital auxiliary input heading.

2.9.10 Menu 10—Output Setup

Menu 10 provides setup of the user-defined system, digital and analog status and fault outputs, and relay driver outputs (RDO) 1–31. These outputs provide a multitude of choices for configuring customized auxiliary outputs. Additional individual outputs are available for monitoring, diagnostic, and control functions.

The user must enable the programming mode to edit the display.

Note: Some data require entry using a PC in the Remote Programming mode. See the monitor software operation manual for details.

Common Faults

The user can program a single fault comprised of status and fault events from 3 common fault programs—system, digital, and analog faults.

Up to 66 user-defined *system events* are available, which provide status and fault information. See Group B on the following pages for specific descriptions. The NFPA-110 faults are part of the *system* fault program and are comprised of 15 individual faults shown on this page.

Up to 21 user-defined *digital* status and fault events designated as D01 to D21 are available. Each of the 21 status events and faults are assignable as shutdowns or warnings.

Up to 7 user-defined *analog* status events and faults designated as A01 to A07 are available. Each of the 7 status events and faults are assignable as shutdowns or warnings with high or low settings for a total of up to 7 status events and fault functions.

Relay Driver Outputs (RDOs)

Up to 31 *RDOs* are available using the system, digital, and analog status events and faults. RDOs provide only the relay driver, not the relay. The contact relays that interface with other equipment are user supplied.

Note: *Func(Function) Used by (RDO) XX Reassign?* appears when the user attempts to assign an RDO to a function already assigned.

Note: *Cannot Change (because the) NFPA is Enabled* appears when the user attempts to modify an RDO setting that is a NFPA 110 default requirement.

Software Controlled RDOs (SCRDOs)

The SCRDO is set up and enabled using the keypad or PC. See the monitor software operation manual when reactivating the SCRDO. The user can deactivate an SCRDO at the controller. The user cannot reactivate the SCRDO at the controller. The procedure to deactivate the SCRDO appears at the end of Menu 10—Output Setup, Displays with Entry Keys—Deactivating the SCRDO. The user must enable the programming mode to edit the display.

NFPA 110 Faults

The 15 NFPA 110 fault alarms include the following:

- Overspeed
- Overcrank
- High Coolant Temperature Shutdown
- Oil Pressure Shutdown
- Low Coolant Temperature
- High Coolant Temperature Warning
- Oil Pressure Warning
- Low Fuel
- Master Not in Auto
- Battery Charger Fault
- Low Battery Voltage
- High Battery Voltage
- Low Coolant Level
- EPS Supplying Load
- Air Damper Indicator

Defined Common Faults

The 5 defined common faults include the following:

- Emergency Stop
- High Coolant Temperature Shutdown
- Oil Pressure Shutdown
- Overcrank
- Overspeed

Menu 10—Output Setup

Menu 10 Displays with Key Entries

Key Entry	Display	Description
	ENTER MENU NO. 1-15	Input a menu number.
	MAIN MENU NUMBER 10	Press the Enter key.
	MENU 10 OUTPUT SETUP	Displays the menu number and name.
	DEFINE COMMON FAULTS →	Displays the common faults heading.

	SYSTEM EVENTS →	Displays the system events heading.
	COMMON FAULT Y/N (see Group B)	Gives the user the option to add or delete the selection from the defined system events group. Press the Menu Down key to continue to the next selection (repeat as necessary).

	COMMON FAULT NO (see Group B)	Entering YES adds the selection to the defined system event group.
	COMMON FAULT YES (see Group B)	Press the Enter key.
	COMMON FAULT YES (see Group B)	Confirms the entry.

OR		
	COMMON FAULT YES (see Group B)	Entering NO removes the selection from the defined system event group.
	COMMON FAULT NO (see Group B)	Press the Enter key.
	COMMON FAULT NO (see Group B)	Confirms the entry.

Group B	Group B, continued	Group B, continued
For defined system events, choose from the following 66 status events and faults by changing selection to YES. See Appendix E for application and restrictions with specific engines. EMERGENCY STOP OVER SPEED OVER CRANK HI COOL TEMP SHUTDWN OIL PRESS SHUTDOWN LOW COOLANT TEMP (non-ECM engines) LOW FUEL HI COOL TEMP WARNING OIL PRES WARNING MASTER NOT IN AUTO NFPA 110 FAULT (see Menu 10 introduction for list) LOW BATTERY VOLTAGE HIGH BATTERY VOLTAGE BATTERY CHARGE FAULT SYSTEM READY LOSS OF ECM COMM (ECM engines)	NO OIL PRESS SIGNAL HI OIL TEMP NO COOL TEMP SIGNAL LOW COOLANT LEVEL SPEED SENSOR FAULT LOCKED ROTOR MASTER SWITCH ERROR MASTER SWITCH OPEN MASTER SWITCH TO OFF AC SENSING LOSS OVER VOLTAGE UNDER VOLTAGE WEAK BATTERY OVER FREQUENCY UNDER FREQUENCY LOAD SHED KW OVER LOAD SHED UNDER FREQ OVER CURRENT EPS SUPPLYING LOAD INTERNAL FAULT DELAY ENG COOLDOWN DELAY ENG START STARTING AID GENERATOR SET RUNNING	AIR DAMPER CONTROL GROUND FAULT EEPROM WRITE FAILURE CRITICAL OVERVOLTAGE ALTERNATOR PROTECTION SHUTDOWN AIR DAMPER INDICATOR DEFINED COMMON FAULT (RDO only) (see Menu 10 introduction for list) SCRDOs 1-4 (software controlled RDOs) MAINTENANCE DUE ENGINE DERATE ACTIVE ENGINE STALLED (ECM engine) J1939 CAN SHUTDOWN (ECM engine) Paralleling Applications only: SD REVERSE POWER SD OVER POWER SD LOSS OF FIELD SD OVERCURRENT PR COMMON PR OUTPUT IN SYNCH BREAKER TRIP
		Group B, continued Waukesha-Powered models only: FUEL VALVE RELAY PRELUBE RELAY AFM REMOTE START NO OIL TEMP SIGNAL HI OIL TEMP WARNING NO AIR TEMP SIGNAL INTAKE AIR TEMP WARN INTAKE AIR TEMP SDWN AFM ENG START RELAY DDC/MTU engine with MDEC/ADEC only: HI OIL TEMP WARNING INTAKE AIR TEMP WARN INTAKE AIR TEMP SDWN ECM YELLOW ALARM ECM RED ALARM BLOCK HEATER CONTROL LOW COOL TEMP SDOWN LOAD SHED OVER TEMP 1750/2000REOZMD only: TURBO TEMP WARNING TURBO TEMP SHUTDOWN

Menu 10—Output Setup, continued

Menu 10 Displays with Key Entries

Key Entry	Display	Description
	DIGITAL INPUTS →	Displays the digital inputs heading.
	COMMON FAULT Y/N Dxx (see Group C)	Gives the user the option to add or delete selection from the defined digital faults starting with D01. Note: Press the Menu Down key to continue to the next selection D02–D21 (repeat as necessary).
	COMMON FAULT NO Dxx (see Group C)	Entering YES adds the selection to the defined digital fault group.
	COMMON FAULT YES Dxx (see Group C)	Press the Enter key.
	COMMON FAULT YES Dxx (see Group C)	Confirms the entry.
OR		
	COMMON FAULT YES Dxx (see Group C)	Entering NO removes the selection from the defined digital fault group.
	COMMON FAULT NO Dxx (see Group C)	Press the Enter key.
	COMMON FAULT NO Dxx (see Group C)	Confirms the entry.
<p>Group C Up to 21 PC user-defined digital status and fault inputs designated as D01 to D21 can result in a digital input common fault.</p>		
	ANALOG INPUTS →	Displays the analog inputs heading.
	COMMON FAULT Y/N Axx(see Group D) WARNING→	Gives the user the option to add or delete selection from the defined analog faults starting with A01. Note: Press the Menu Down key to continue to the next selection A02–A07 (repeat as necessary).
<p>Group D Up to 7 analog inputs, PC user-defined status events and faults designated as A01 to A07. Each of the 7 is assignable as a shutdown or warning with high and low settings.</p>		

Menu 10—Output Setup, continued

Menu 10 Displays with Key Entries

Key Entry	Display	Description
(A)	COMMON FAULT Y/N A01 LO WARNING→	Indicates whether the previously user-defined analog output was selected (yes or no) as a low warning fault.
7 YES	COMMON FAULT NO A01 LO WARNING→ COMMON FAULT YES A01 LO WARNING→	Entering YES adds the low warning selection to the defined analog fault group. Press the Enter key.
ENTER	COMMON FAULT YES A01 LO WARNING→	Confirms the entry.
8 NO	OR COMMON FAULT YES A01 LO WARNING→ COMMON FAULT NO A01 LO WARNING→	Entering NO removes the low warning selection from the defined analog fault group. Press the Enter key.
ENTER	COMMON FAULT NO A01 LO WARNING→	Confirms the entry.
MENU	COMMON FAULT Y/N A01 HI WARNING→	Indicates whether the previously user-defined analog output was selected (yes or no) as a high warning fault.
7 YES	COMMON FAULT NO A01 HI WARNING→ COMMON FAULT YES A01 HI WARNING→	Entering YES adds the high warning selection to the defined analog fault group. Press the Enter key.
ENTER	COMMON FAULT YES A01 HI WARNING→	Confirms the entry.
8 NO	OR COMMON FAULT YES A01 HI WARNING→ COMMON FAULT NO A01 HI WARNING→	Entering NO removes the high warning selection from the defined analog fault group. Press the Enter key.
ENTER	COMMON FAULT NO A01 HI WARNING→	Confirms the entry.

Menu 10—Output Setup, continued

Menu 10 Displays with Key Entries

Key Entry	Display	Description
MENU →	COMMON FAULT Y/N A01 LO SHUTDOWN→	Indicates whether the previously user-defined analog output was selected (yes or no) as a low shutdown fault.
7 YES	COMMON FAULT NO A01 LO SHUTDOWN→	Entering YES adds the low shutdown selection to the defined analog fault group.
ENTER ↵	COMMON FAULT YES A01 LO SHUTDOWN→	Press the Enter key.
ENTER ↵	COMMON FAULT YES A01 LO SHUTDOWN→	Confirms the entry.
8 NO	OR COMMON FAULT YES A01 LO SHUTDOWN→	Entering NO removes the low shutdown selection from the defined analog fault group.
ENTER ↵	COMMON FAULT NO A01 LO SHUTDOWN→	Press the Enter key.
ENTER ↵	COMMON FAULT NO A01 LO SHUTDOWN→	Confirms the entry.
MENU →	COMMON FAULT Y/N A01 HI SHUTDOWN→	Indicates whether the previously user-defined analog output was selected (yes or no) as a high shutdown fault.
7 YES	COMMON FAULT NO A01 HI SHUTDOWN→	Entering YES adds the high shutdown selection to the defined analog fault group.
ENTER ↵	COMMON FAULT YES A01 HI SHUTDOWN→	Press the Enter key.
ENTER ↵	COMMON FAULT YES A01 HI SHUTDOWN→	Confirms the entry.
8 NO	OR COMMON FAULT YES A01 HI SHUTDOWN→	Entering NO removes the high shutdown selection from the defined analog fault group.
ENTER ↵	COMMON FAULT NO A01 HI SHUTDOWN→	Press the Enter key.
ENTER ↵	COMMON FAULT NO A01 HI SHUTDOWN→	Confirms the entry.
MENU →	COMMON FAULT Y/N A01 LO WARNING→	Returns the user to common fault (analog inputs) heading. Press the Menu Down key to continue to the next selection A02–A07 (repeat as necessary).
MENU ↓	COMMON FAULT Y/N Axx(see Group D) LO WARNING→ Group D Up to 7 analog inputs, PC user-defined status events and faults designated as A01 to A07. Each of the 7 is assignable as a shutdown or warning with high and low settings.	Gives the user the option to add or delete selection from the next defined analog fault. Note: Use the A01 common fault analog input setup procedure shown above for A02–A07. Go to A

Menu 10—Output Setup, continued

Menu 10 Displays with Key Entries

Key Entry	Display	Description
	ANALOG INPUTS →	Returns the user to analog inputs heading.
	DEFINE COMMON FAULTS →	Returns the user to the define common faults heading.
©	RELAY DRV OUT 01 (user defined) →	Gives the user previously selected items for relay driver outputs (RDO) starting with 01. Note: Press the down arrow to continue to the next relay driver output 02-31 or enter the RDO number. Note: The RDO can be assigned from the SYSTEM EVENTS, DIGITAL INPUTS, or ANALOG INPUTS groups. The start of each of these groups are highlighted on the following pages.
	SYSTEM EVENTS →	Displays the system events heading.
<hr/>		
	RELAY DRV OUT 01 Y/N (see Group B)	Gives the user the option to assign a system event to an RDO. Press the Menu Down key to continue to the next selection (repeat as necessary).
	RELAY DRV OUT 01 NO (see Group B)	Entering YES adds the selection to the RDO group. Note: <i>Func(Function) Used by (RDO) XX Reassign?</i> appears when the user attempts to assign an RDO to a function already assigned. Note: <i>Cannot Change (because the) NFPA is Enabled</i> appears when the user attempts to modify the RDO setting that is a NFPA 110 default requirement.
	RELAY DRV OUT 01 YES (see Group B)	Press the Enter key.
	RELAY DRV OUT 01 YES (see Group B)	Confirms the entry.

Group B

For defined system events, choose from the following 66 status events and faults by changing selection to YES. See Appendix E for application and restrictions with specific engines.

- EMERGENCY STOP
- OVER SPEED
- OVER CRANK
- HI COOL TEMP SHUTDWN
- OIL PRESS SHUTDOWN
- LOW COOLANT TEMP (non-ECM engines)
- LOW FUEL
- HI COOL TEMP WARNING
- OIL PRES WARNING
- MASTER NOT IN AUTO
- NFPA 110 FAULT*
- LOW BATTERY VOLTAGE
- HIGH BATTERY VOLTAGE
- BATTERY CHARGE FAULT
- SYSTEM READY
- LOSS OF ECM COMM (ECM engines)
- NO OIL PRESS SIGNAL
- HI OIL TEMP
- NO COOL TEMP SIGNAL
- LOW COOLANT LEVEL
- SPEED SENSOR FAULT
- LOCKED ROTOR
- MASTER SWITCH ERROR
- MASTER SWITCH OPEN

Group B, continued

- MASTER SWITCH TO OFF
- AC SENSING LOSS
- OVER VOLTAGE
- UNDER VOLTAGE
- WEAK BATTERY
- OVER FREQUENCY
- UNDER FREQUENCY
- LOAD SHED KW OVER
- LOAD SHED UNDER FREQ
- OVER CURRENT
- EPS SUPPLYING LOAD
- INTERNAL FAULT
- DELAY ENG COOLDOWN
- DELAY ENG START
- STARTING AID
- GENERATOR SET RUNNING
- AIR DAMPER CONTROL
- GROUND FAULT
- EEPROM WRITE FAILURE
- CRITICAL OVERVOLTAGE
- ALTERNATOR PROTECTION SHUTDOWN
- AIR DAMPER INDICATOR
- DEFINED COMMON FAULT (RDO only)†
- SCRDOs 1-4 (software controlled RDOs)
- MAINTENANCE DUE
- ENGINE DERATE ACTIVE
- ENGINE STALLED (ECM engines)
- J1939 CAN ENGINE SHUTDOWN (ECM engines)

Group B, continued

Paralleling Applications:

- SD REVERSE POWER
- SD OVER POWER
- SD LOSS OF FIELD
- SD OVERCURRENT PR
- COMMON PR OUTPUT
- IN SYNCH
- BREAKER TRIP

Waukesha-powered models:

- FUEL VALVE RELAY
- PRELUBE RELAY
- AFM REMOTE START
- NO OIL TEMP SIGNAL
- HI OIL TEMP WARNING
- NO AIR TEMP SIGNAL
- INTAKE AIR TEMP WARN
- INTAKE AIR TEMP SDWN
- AFM ENG START DELAY

DDC/MTU engine with MDEC/ADEC:

- HI OIL TEMP WARNING
- INTAKE AIR TEMP WARN
- INTAKE AIR TEMP SDWN
- ECM YELLOW ALARM
- ECM RED ALARM
- BLOCK HEATER CONTROL
- LOW COOL TEMP SDOWN
- LOAD SHED OVER TEMP

1750/2000REOZMD only:

- TURBO TEMP WARNING
- TURBO TEMP SHUTDOWN

*NFPA 110 FAULT

The 15 NFPA-110 Fault Alarms include the following:

- OVERSPEED
- OVERCRANK
- HIGH COOLANT TEMP SHUTDOWN
- OIL PRESSURE SHUTDOWN
- LOW COOLANT TEMPERATURE
- HIGH COOLANT TEMP WARNING
- OIL PRESSURE WARNING
- LOW FUEL
- MASTER NOT IN AUTO
- BATTERY CHARGER FAULT
- LOW BATTERY VOLTAGE
- HIGH BATTERY VOLTAGE
- LOW COOLANT LEVEL
- EPS SUPPLYING LOAD
- AIR DAMPER INDICATOR







†DEFINED COMMON FAULT

The 5 defined common faults include the following:

- EMERGENCY STOP
- HI COOL TEMP SHUTDOWN
- OIL PRESS SHUTDOWN
- OVERCRANK
- OVERSPEED

Menu 10—Output Setup, continued

Menu 10 Displays with Key Entries

Key Entry	Display	Description
	DIGITAL INPUTS →	Displays the digital inputs heading.
	RELAY DRV OUT 01 Y/N Dxx (see Group C)	Gives the user the option to assign a digital input to an RDO starting with D01. Press the Menu Down key to continue to the next selection D02-D21 (repeat as necessary). Note: <i>Func(Function) Used by (RDO) XX Reassign?</i> appears when the user attempts to assign an RDO to a function already assigned.
<hr/>		
	RELAY DRV OUT 01 NO Dxx (see Group C)	Entering YES adds the selection to the RDO group. Note: <i>Func(Function) Used by (RDO) XX Reassign?</i> appears when the user attempts to assign an RDO to a function already assigned. Note: <i>Cannot Change (because the) NFPA is Enabled</i> appears when the user attempts to modify the RDO setting that is a NFPA 110 default requirement.
	RELAY DRV OUT 01 YES Dxx (see Group C)	Press the Enter key.
	RELAY DRV OUT 01 YES Dxx (see Group C)	Confirms the entry.
	Group C Up to user-defined digital status and fault inputs designated as D01 to D21 can result in a digital input common fault.	
<hr/>		
	ANALOG INPUTS →	Displays the analog inputs heading.
	RELAY DRV OUT 01 Y/N Axx(see Group D) LO WARNING→	Gives the user the option to assign an analog input to an RDO starting with A01. Note: Press the Menu Down key to continue to the next selection A02-A07 (repeat as necessary).
	Group D Up to 7 analog inputs, user-defined status events and faults designated as A01 to A07. Each of the 7 is assignable as a shutdown or warning with high or low settings.	
<hr/>		

Menu 10—Output Setup, continued

Menu 10 Displays with Key Entries

Key Entry	Display	Description
MENU ▶	RELAY DRV OUT 01 Y/N A01 LO WARNING→	Indicates whether the previously user-defined analog RDO was selected (yes or no) as a low warning fault.
7 YES	RELAY DRV OUT 01 NO A01 LO WARNING→	Entering YES adds the low warning selection to the defined analog RDO group.
ENTER ↵	RELAY DRV OUT 01 YES A01 LO WARNING→	Press the Enter key.
ENTER ↵	RELAY DRV OUT 01 YES A01 LO WARNING→	Confirms the entry.
OR		
8 NO	RELAY DRV OUT 01 YES A01 LO WARNING→	Entering NO removes the low warning selection from the defined analog RDO group.
ENTER ↵	RELAY DRV OUT 01 NO A01 LO WARNING→	Press the Enter key.
ENTER ↵	RELAY DRV OUT 01 NO A01 LO WARNING→	Confirms the entry.
MENU ▶	RELAY DRV OUT 01 Y/N A01 HI WARNING→	Indicates whether the previously user-defined analog RDO was selected (yes or no) as a high warning fault.
7 YES	RELAY DRV OUT 01 NO A01 HI WARNING→	Entering YES adds the high warning selection to the defined analog RDO group.
ENTER ↵	RELAY DRV OUT 01 YES A01 HI WARNING→	Press the Enter key.
ENTER ↵	RELAY DRV OUT 01 YES A01 HI WARNING→	Confirms the entry.
OR		
8 NO	RELAY DRV OUT 01 YES A01 HI WARNING→	Entering NO removes the high warning selection from the defined analog RDO group.
ENTER ↵	RELAY DRV OUT 01 NO A01 HI WARNING→	Press the Enter key.
ENTER ↵	RELAY DRV OUT 01 NO A01 HI WARNING→	Confirms the entry.

Menu 10—Output Setup, continued

Menu 10 Displays with Key Entries

Key Entry	Display	Description
MENU ▶	RELAY DRV OUT 01 Y/N A01 LO SHUTDOWN→	Indicates whether the previously user-defined analog RDO was selected (yes or no) as a low shutdown fault.
7 YES	RELAY DRV OUT 01 NO A01 LO SHUTDOWN→	Entering YES adds the low shutdown selection to the defined analog RDO group.
ENTER ↵	RELAY DRV OUT 01 YES A01 LO SHUTDOWN→	Press the Enter key.
ENTER ↵	RELAY DRV OUT 01 YES A01 LO SHUTDOWN→	Confirms the entry.
OR		
8 NO	RELAY DRV OUT 01 YES A01 LO SHUTDOWN→	Entering NO removes the low shutdown selection from the defined analog RDO group.
ENTER ↵	RELAY DRV OUT 01 NO A01 LO SHUTDOWN→	Press the Enter key.
ENTER ↵	RELAY DRV OUT 01 NO A01 LO SHUTDOWN→	Confirms the entry.
MENU ▶	RELAY DRV OUT 01 Y/N A01 HI SHUTDOWN→	Indicates whether the previously user-defined analog RDO was selected (yes or no) as a high shutdown fault.
7 YES	RELAY DRV OUT 01 NO A01 HI SHUTDOWN→	Entering YES adds the high shutdown selection to the defined analog RDO group.
ENTER ↵	RELAY DRV OUT 01 YES A01 HI SHUTDOWN→	Press the Enter key.
ENTER ↵	RELAY DRV OUT 01 YES A01 HI SHUTDOWN→	Confirms the entry.
OR		
8 NO	RELAY DRV OUT 01 YES A01 HI SHUTDOWN→	Entering NO removes the high shutdown selection from the defined analog RDO group.
ENTER ↵	RELAY DRV OUT 01 NO A01 HI SHUTDOWN→	Press the Enter key.
ENTER ↵	RELAY DRV OUT 01 NO A01 HI SHUTDOWN→	Confirms the entry.
MENU ▶	RELAY DRV OUT 01 Y/N A01 LO WARNING→	Returns the user to the analog RDO (analog inputs) heading. Press the Menu Down key to continue to the next selection A02-A07 (repeat as necessary).
MENU ▼	RELAY DRV OUT 01 Y/N Axx(see Group D) LO WARNING→	Gives the user the option to add or delete a selection for the next analog RDO. Note: Use the A01 analog RDO setup procedure shown above for A02-A07. Go to B
MENU ▼	ANALOG INPUTS →	Returns the user to the analog inputs heading. Press the Menu Right key.
MENU ▶	RELAY DRV OUT 01 → (user defined)	Returns the user to the RDO 01 heading.
MENU ▼	RELAY DRV OUT XX → (user defined)	Gives the user the option to add or delete a selection for the next RDO. Note: Use the RDO 01 setup procedure shown above for RDOs 02-31. Go to C

Menu 10—Output Setup, continued

Menu 10 Displays with Key Entries— Deactivating the SCRDO

Key Entry	Display	Description
RESET MENU	ENTER MENU NO. 1-15	Input a menu number.
1 0 LAMP TEST	MAIN MENU NUMBER 10	Press the Enter key.
ENTER	MENU 10 OUTPUT SETUP	Displays the menu number and name
MENU	DEFINE COMMON FAULTS →	Displays the common faults heading.
MENU	RELAY DRV OUT XX → S'WARE CONTROLLED #X	Gives the user previously selected items for the relay driver outputs (RDO). Press the down arrow to scroll through relay driver outputs 1-31 or enter the RDO number. Locate the SCRDO display.
MENU	DEACTIVATE RDO? →	When required (SCRDO is currently active), enter the YES key to deactivate the SCRDO.
7 YES	DEACTIVATE RDO? YES →	Press the Enter key.
ENTER	RELAY DRV OUT XX → S'WARE CONTROLLED #X	

2.9.11 Menu 11—Voltage Regulator

Menu 11 provides the setup of the voltage regulator functions including the line-to-line voltages, underfrequency unloading (volts per Hz), reactive droop, power factor, and kVAR adjustments. See Section 1.3.3, Voltage Regulator Adjustments, and Appendix C, Voltage Regulator Definitions and Adjustments, for additional information.

The user must enable the programming mode to edit the display.

Note: Press the Menu Right → key prior to entering the decimal values where necessary.











Note: 350–2000 kW models only, see 1.3.2 Voltage Regulator and Calibration Specifications regarding the use of the Marathon® DVR® 2000 voltage regulator on some earlier generator sets.

Analog Voltage Adjust. Analog input A07 is the voltage adjustment for paralleling applications only. This input adjusts the input up or down from the value entered in Menu 11, Voltage Regulator. If the keypad entry does not match the displayed value for voltage adjust, the analog input is likely not at zero (2.5 VDC). Analog input A07 can be monitored or checked in Menu 3, Analog Monitoring.

Note: Utility paralleling applications require enabling the VAR/PF controls. The Utility Gain Adjust is used for VAR or PF stability adjustment while paralleling to a utility.

Marathon® and DVR® are registered trademarks of Marathon Electric Mfg. Corp.

Menu 11—Voltage Regulator Menu 11 Displays with Key Entries

Key Entry	Display	Description
	ENTER MENU NO. 1-15	Input a menu number.
 	MAIN MENU NUMBER 11	Press the Enter key.
	MENU 11 VOLTAGE REGULATOR	Displays the menu number and name.
<hr/>		
	AVG L-L V #→ VOLT ADJ ??	Displays the average running line-to-line volts and voltage adjustment. Enter the desired nominal voltage using the numeric keys. Press the Menu Right → key prior to entering the decimal value.
	AND AVG L-L V #→ VOLT ADJ ??	Use the numeric keys to enter the <i>decimal</i> value. Press the Enter key.
	AVG L-L V #→ VOLT ADJ ##	Confirms the entry.
<hr/>		
	L1-L2 VOLTS → #	Displays L1-L2 volts.
	L2-L3 VOLTS → #	Displays L2-L3 volts (3 phase only).
	L3-L1 VOLTS → #	Displays L3-L1 volts (3 phase only).
	AVG L-L V #→ VOLT ADJ #	Returns the user to the average line-to-line volts and voltage adjustment heading.

Menu 11—Voltage Regulator, continued

Menu 11 Displays with Key Entries

Key Entry	Display	Description
MENU ↓	UNDER FREQ UNLOAD → ENABLED N/Y	Displays the under frequency (volts per Hz) unloading (yes or no) selection.
7 YES	UNDER FREQ UNLOAD → ENABLED NO	Entering YES enables the underfrequency unloading feature.
ENTER ↵	UNDER FREQ UNLOAD → ENABLED YES	Press the Enter key.
ENTER ↵	UNDER FREQ UNLOAD → ENABLED YES	Confirms the entry.
OR		
8 NO	UNDER FREQ UNLOAD → ENABLED YES	Entering NO disables the underfrequency unloading feature.
ENTER ↵	UNDER FREQ UNLOAD → ENABLED NO	Press the Enter key.
ENTER ↵	UNDER FREQ UNLOAD → ENABLED NO	Confirms the entry.
MENU →	FREQUENCY # HZ→ SETPOINT ?.? HZ	Displays the present operating frequency and underfrequency unloading cut-in point. Enter the desired underfrequency cut-in point using the numeric keys. Press the Menu Right → key prior to entering the decimal value.
AND		
MENU →	FREQUENCY # HZ→ SETPOINT ?.? HZ	Use the numeric keys to enter the <i>decimal</i> value. Press the Enter key.
ENTER ↵	FREQUENCY # HZ→ SETPOINT ## HZ	Confirms the entry.
MENU →	SLOPE → ?.? VOLTS-PER-CYCLE	Displays the underfrequency unloading slope (volts-per-cycle). Enter the desired underfrequency unloading slope using the numeric keys. Press the Menu Right → key prior to entering the decimal value.
AND		
MENU →	SLOPE → ?.? VOLTS-PER-CYCLE	Use the numeric keys to enter the <i>decimal</i> value. Press the Enter key.
ENTER ↵	SLOPE → ## VOLTS-PER-CYCLE	Confirms the entry.
MENU →	UNDER FREQ UNLOAD → ENABLED N/Y	Returns the user to the underfrequency unloading heading.

Menu 11—Voltage Regulator, continued

Menu 11 Displays with Key Entries

Key Entry	Display	Description
MENU ↓	REACTIVE DROOP ENABLED → N/Y	Displays the reactive droop selection (yes or no).
<hr/>		
7 YES	REACTIVE DROOP ENABLED → NO	Entering YES enables the reactive droop feature.
ENTER ↵	REACTIVE DROOP ENABLED → YES	Press the Enter key.
ENTER ↵	REACTIVE DROOP ENABLED → YES	Confirms the entry.
<hr/>		
OR		
8 NO	REACTIVE DROOP ENABLED → YES	Entering NO disables the reactive droop feature.
ENTER ↵	REACTIVE DROOP ENABLED → NO	Press the Enter key.
ENTER ↵	REACTIVE DROOP ENABLED → NO	Confirms the entry.
<hr/>		
MENU →	.8 PF RATED LOAD VOLTAGE DROOP → ?.?%	Displays the reactive (voltage) droop as a percentage of the rated voltage at rated load. When required, enter the desired reactive droop using the numeric keys. Press the Menu Right → key prior to entering the decimal value.
<hr/>		
AND		
MENU →	.8 PF RATED LOAD VOLTAGE DROOP → ?.?%	Use the numeric keys to enter the <i>decimal</i> value. Press the Enter key.
ENTER ↵	.8 PF RATED LOAD VOLTAGE DROOP → #.##%	Confirms the entry.
<hr/>		

Menu 11—Voltage Regulator, continued

Menu 11 Displays with Key Entries

Key Entry	Display	Description
MENU →	REACTIVE DROOP ENABLED → N/Y	Returns the user to reactive droop selection heading.
MENU ↓	VAR CONTROL ENABLED → N/Y	Displays the VAR control selection (yes or no).
7 YES	VAR CONTROL ENABLED → NO	Entering YES enables the VAR control feature. Note: A YES entry disables the PF control if previously activated.
ENTER ↵	VAR CONTROL ENABLED → YES	Press the Enter key.
ENTER ↵	VAR CONTROL ENABLED → YES	Confirms the entry.
OR		
8 NO	VAR CONTROL ENABLED → YES	Entering NO disables the VAR control feature.
ENTER ↵	VAR CONTROL ENABLED → NO	Press the Enter key.
ENTER ↵	VAR CONTROL ENABLED → NO	Confirms the entry.
MENU →	TOTAL KVAR #→ KVAR ADJ ??	Displays total kVAR (running) and kVAR adjustment settings. Enter the desired kVAR adjustment using the numeric keys. Press the Menu Right → key prior to entering the decimal value.
AND		
MENU →	TOTAL KVAR #→ KVAR ADJ ??	Use the numeric keys to enter the <i>decimal</i> value. Press the Enter key.
ENTER ↵	TOTAL KVAR #→ KVAR ADJ ##	Confirms the entry.
MENU →	GENERATING/ ABSORBING N/Y→	Displays the generating <i>or</i> absorbing kVAR selection. Note: The display sample may differ depending upon the previous entries. The generating selection is the factory default setting.
OR		
8 NO	GENERATING YES→	Displays the generating kVAR selection. When required, use the NO key to choose absorbing kVAR.
ENTER ↵	GENERATING NO→	Press the Enter key.
ENTER ↵	ABSORBING YES→	Confirms the entry.
OR		
8 NO	ABSORBING YES→	Displays the absorbing kVAR selection. When required, use the NO key to choose generating kVAR.
ENTER ↵	ABSORBING NO→	Press the Enter key.
ENTER ↵	GENERATING YES→	Confirms the entry.
MENU →	VAR CONTROL ENABLED → N/Y	Returns the user to VAR control selection heading.









Menu 11—Voltage Regulator, continued

Menu 11 Displays with Key Entries

Key Entry	Display	Description
MENU ▼	PF CONTROL → ENABLED N/Y	Displays the power factor control selection (yes or no).
7 YES	PF CONTROL → ENABLED NO	Entering YES enables the power factor control feature. Note: A YES entry disables the kVAR control if previously activated.
	PF CONTROL → ENABLED YES	Press the Enter key.
ENTER ↵	PF CONTROL → ENABLED YES	Confirms the entry.
OR		
8 NO	PF CONTROL → ENABLED YES	Entering NO disables the power factor control feature.
	PF CONTROL → ENABLED NO	Press the Enter key.
ENTER ↵	PF CONTROL → ENABLED NO	Confirms the entry.
MENU ▶	AVERAGE PF #→ PF ADJ ??	Displays the present running average power factor and power factor adjustment settings. Enter the desired kVAR adjustment using the numeric keys. Press the Menu Right → key prior to entering the decimal value.
AND		
MENU ▶	AVERAGE PF #→ PF ADJ ??	Use the numeric keys to enter the <i>decimal</i> value. Press the Enter key.
ENTER ↵	AVERAGE PF #→ PF ADJ ##	Confirms the entry.
MENU ▶	LAGGING/ LEADING N/Y→	Displays the lagging <i>or</i> leading PF selection. Note: The display sample may differ depending upon the previous entries. The lagging selection is the factory default setting.
8 NO	LAGGING YES→	Displays the lagging PF selection. When required, use the NO key to choose leading PF.
	LAGGING NO→	Press the Enter key.
ENTER ↵	LEADING YES→	Confirms the entry.
OR		
8 NO	LEADING YES→	Displays the leading PF selection. When required, use the NO key to choose lagging PF.
	LEADING NO→	Press the Enter key.
ENTER ↵	LAGGING YES→	Confirms the entry.
MENU ▶	PF CONTROL → ENABLED N/Y	Returns the user to the power factor control selection heading.

Menu 11—Voltage Regulator, continued

Menu 11 Displays with Key Entries

Key Entry	Display	Description
	REGULATOR GAIN ADJ GAIN #	Displays the generator set voltage regulator gain adjustment. When required, use the numeric keys to enter the desired gain value.
	REGULATOR GAIN ADJ GAIN #	Confirms the entry.
	VAR/PF GAIN ADJ GAIN #	Displays the utility (VAR/PF) gain adjustment. When required, use the numeric keys to enter the desired gain value.
	VAR/PF GAIN ADJ GAIN #	Confirms the entry.
	ANALOG VOLT ADJUST ENABLED? Y/N	Displays current status and provides a means to change the status.
	RESET REGULATOR DEFAULTS Y/N	Displays the reset regulator defaults selection.
	RESET REGULATOR DEFAULTS YES	When required, use the YES key to reset the regulator defaults.
	RESET REGULATOR DEFAULTS Y/N	Confirms the entry.

2.9.12 Menu 12—Calibration

Menu 12 provides the calibration of the voltage and current sensing logic. Changing the system voltage or replacing the main logic control circuit board requires a calibration adjustment.

The user must enable the programming mode to edit the display.

Connect a meter with a minimum accuracy of $\pm 1\%$ to the generator set output leads to calibrate the voltage-sensing logic. Configure the generator set controller for the system operating configuration using Menu 7—Generator System. Adjust the generator set voltage using Menu 11—Voltage Regulator, when required and adjust the frequency at the generator set governor before making calibration adjustments.

Reduce the voltage regulator gain using Menu 11, Voltage Regulator until the voltage is stable prior to calibration.

The user must scale the analog input value in order to calculate the low/high warning and shutdown analog values based on a 0–5 VDC scale.

ECM engines have user-defined analog inputs A01–A07. Non-ECM engines have user-defined analog inputs A03–A07 where analog inputs A01 and A02 are reserved for the engine coolant temperature A01 and oil pressure A02 displays.

Analog Input A06—Analog Speed Adjust (VSG). Analog Input A06 may be used for analog speed adjust when external control of engine speed is desired such as paralleling applications or closed transition ATS. To utilize this capability, set the Speed Adjust to ANALOG VSG A06 in Menu 7. Refer to 2.9.7, Menu 7

Note: On controller firmware versions prior to 3.4.3, analog input A06 must be calibrated to utilize. Calibration for this input is not necessary with firmware versions 3.4.3 or higher.

Note: For VSG on Analog Aux. Input 06 calibrate :
Volvo: 0.5V=1250; 4.5V=8750
GM/Doosan at 60 Hz: 0.5V=2375; 4.5V=2625
GM/Doosan at 50 Hz: 0.5V=2327; 4.5V=2624









Analog input A07 is the voltage adjustment for paralleling applications only. This input adjusts the input up or down from the value entered in Menu 11, Voltage Regulator. Calibration is not necessary.

Note: Press the Menu Right → key prior to entering decimal values where necessary.

Changes to the generator set system parameters causes a CHECK CALIBRATION display message. If the generator set system parameters are changed, verify the controller display calibration by comparing the results to a known measured value.















Menu 12—Calibration

Menu 12 Displays with Key Entries (Scale AC Analog Inputs)

Key Entry	Display	Description
	ENTER MENU NO. 1-15	Input a menu number.
 	MAIN MENU NUMBER 12	Press the Enter key.
	MENU 12 CALIBRATION	Displays the menu number and name.
	SCALE AC ANALOG INPUTS	Displays the scale AC analog inputs heading.
	GEN VOLTAGE LN	Displays the generator set voltage line-to-neutral heading.
	GEN L1-L0 V # CALIB REF ??	Note: The generator set must be running for the following steps. Measure the generator set output voltage for single and three-phase models between L1-L0 using a voltmeter and enter the result using the numeric keys. Press the Menu Right → key prior to entering the decimal value.
	AND	
	GEN L1-L0 V # CALIB REF ??	Use the numeric keys to enter the <i>decimal</i> value. Press the Enter key.
	GEN L1-L0 V # CALIB REF ##	Confirms the entry.















Menu 12—Calibration, continued

Menu 12 Displays with Key Entries (Scale AC Analog Inputs)

Key Entry	Display	Description
	<div style="border: 1px solid black; padding: 2px;"> GEN L2-L0 V # CALIB REF ?/? </div>	Measure the generator set output voltage for three-phase models between L2-L0 using a voltmeter and enter the result using the numeric keys. Press the Menu Right → key prior to entering the decimal value.
	AND	
	<div style="border: 1px solid black; padding: 2px;"> GEN L2-L0 V # CALIB REF ?/? </div>	Use the numeric keys to enter the <i>decimal</i> value. Press the Enter key.
	<div style="border: 1px solid black; padding: 2px;"> GEN L2-L0 V # CALIB REF #.# </div>	Confirms the entry.
	<div style="border: 1px solid black; padding: 2px;"> GEN L3-L0 V # CALIB REF ?/? </div>	Three-Phase Models only. Measure the generator set output voltage for three-phase models between L3-L0 using a voltmeter and enter the result using the numeric keys. Press the Menu Right → key prior to entering the decimal value.
	AND	
	<div style="border: 1px solid black; padding: 2px;"> GEN L3-L0 V # CALIB REF ?/? </div>	Use the numeric keys to enter the <i>decimal</i> value. Press the Enter key.
	<div style="border: 1px solid black; padding: 2px;"> GEN L3-L0 V # CALIB REF # </div>	Confirms the entry.
	<div style="border: 1px solid black; padding: 2px;"> GEN VOLTAGE LN </div>	Returns the user to the generator set voltage line-to-neutral heading.
	<div style="border: 1px solid black; padding: 2px;"> GEN VOLTAGE LL </div>	Displays the generator set voltage line-to-line heading.
	<div style="border: 1px solid black; padding: 2px;"> GEN L1-L2 V # CALIB REF ?/? </div>	Note: The generator set must be running for the following steps. Measure the generator set output voltage for single and three-phase models between L1-L2 using a voltmeter and enter the result using the numeric keys. Press the Menu Right → key prior to entering the decimal value.
	AND	
	<div style="border: 1px solid black; padding: 2px;"> GEN L1-L2 V # CALIB REF ?/? </div>	Use the numeric keys to enter the <i>decimal</i> value. Press the Enter key.
	<div style="border: 1px solid black; padding: 2px;"> GEN L1-L2 V # CALIB REF #.# </div>	Confirms the entry.
	<div style="border: 1px solid black; padding: 2px;"> GEN L2-L3 V # CALIB REF ?/? </div>	Three-Phase Models only. Measure the generator set output voltage for three-phase models between L2-L3 using a voltmeter and enter the result using the numeric keys. Press the Menu Right → key prior to entering the decimal value.
	AND	
	<div style="border: 1px solid black; padding: 2px;"> GEN L2-L3 V # CALIB REF ?/? </div>	Use the numeric keys to enter the <i>decimal</i> value. Press the Enter key.
	<div style="border: 1px solid black; padding: 2px;"> GEN L2-L3 V # CALIB REF #.# </div>	Confirms the entry.

















Menu 12—Calibration, continued

Menu 12 Displays with Key Entries (Scale AC Analog Inputs)

Key Entry	Display	Description
	<div style="border: 1px solid black; padding: 2px;"> GEN L3-L1 V # CALIB REF ??. </div>	Three-Phase Models only. Measure the generator set output voltage for three-phase models between L3-L1 using a voltmeter and enter the result using the numeric keys. Press the Menu Right → key prior to entering the decimal value.
	AND	
	<div style="border: 1px solid black; padding: 2px;"> GEN L3-L1 V # CALIB REF ??. </div>	Use the numeric keys to enter the <i>decimal</i> value. Press the Enter key.
	<div style="border: 1px solid black; padding: 2px;"> GEN L3-L1 V # CALIB REF # </div>	Confirms the entry.
	<div style="border: 1px solid black; padding: 2px;"> CALIBRATE REGULATOR? Y/N </div>	Displays the calibrate regulator selection. Note: After changing the meter calibration the voltage regulator should be calibrated—enter YES.
	<div style="border: 1px solid black; padding: 2px;"> CALIBRATE REGULATOR? YES </div>	When required, use the YES key to calibrate the voltage regulator.
	<div style="border: 1px solid black; padding: 2px;"> CALIBRATE REGULATOR? Y/N </div>	Confirms the entry.
	<div style="border: 1px solid black; padding: 2px;"> GEN VOLTAGE LL </div>	Returns the user to the generator set line-to-line voltage heading.
	<div style="border: 1px solid black; padding: 2px;"> GEN AMPS </div>	Displays the generator set amps heading.
	<div style="border: 1px solid black; padding: 2px;"> GEN L1 AMPS # CALIB REF ??. </div>	Note: The generator set must be running for the following steps. Measure the generator set output current for single- and three-phase models at L1 using an AC ammeter and enter the result using the numeric keys. Press the Menu Right → key prior to entering the decimal value.
	AND	
	<div style="border: 1px solid black; padding: 2px;"> GEN L1 AMPS # CALIB REF ??. </div>	Use the numeric keys to enter the <i>decimal</i> value. Press the Enter key.
	<div style="border: 1px solid black; padding: 2px;"> GEN L1 AMPS # CALIB REF # </div>	Confirms the entry.
	<div style="border: 1px solid black; padding: 2px;"> GEN L2 AMPS # CALIB REF ??. </div>	Measure the generator set output current for three-phase models at L2 using an AC ammeter and enter the result using the numeric keys. Press the Menu Right → key prior to entering the decimal value.
	AND	
	<div style="border: 1px solid black; padding: 2px;"> GEN L2 AMPS # CALIB REF ??. </div>	Use the numeric keys to enter the <i>decimal</i> value. Press the Enter key.
	<div style="border: 1px solid black; padding: 2px;"> GEN L2 AMPS # CALIB REF # </div>	Confirms the entry.

Menu 12—Calibration, continued

Menu 12 Displays with Key Entries (Scale AC Analog Inputs)

Key Entry	Display	Description
	<div style="border: 1px solid black; padding: 2px;"> GEN L3 AMPS # CALIB REF ?? </div>	Three-Phase Models only. Measure the generator set output current for three-phase models at L3 using an AC ammeter and enter the result using the numeric keys. Press the Menu Right → key prior to entering the decimal value.
	AND	
	<div style="border: 1px solid black; padding: 2px;"> GEN L3 AMPS # CALIB REF ?? </div>	Use the numeric keys to enter the <i>decimal</i> value. Press the Enter key.
	<div style="border: 1px solid black; padding: 2px;"> GEN L3 AMPS # CALIB REF # </div>	Confirms the entry.
	<div style="border: 1px solid black; padding: 2px;"> GEN AMPS </div>	Returns the user to the generator set amps heading.
	<div style="border: 1px solid black; padding: 2px;"> LOAD VOLTAGE LN </div>	Displays the load voltage line-to-neutral voltage heading.
	<div style="border: 1px solid black; padding: 2px;"> LOAD L1-L0 V # CALIB REF (PARALLEL) ?? </div>	Note: The generator sets must be running for the following steps. Paralleling Applications. Measure the load voltage between L1-L0 using a voltmeter and enter the result using the numeric keys. Press the Menu Right → key prior to entering the decimal value.
	AND	
	<div style="border: 1px solid black; padding: 2px;"> GEN L1-L0 V # CALIB REF ?? </div>	Use the numeric keys to enter the <i>decimal</i> value. Press the Enter key.
	<div style="border: 1px solid black; padding: 2px;"> GEN L1-L0 V # CALIB REF # </div>	Confirms the entry.
	<div style="border: 1px solid black; padding: 2px;"> LOAD L3-L0 V # CALIB REF (PARALLEL) ?? </div>	Note: The generator sets must be running for the following steps. Paralleling Applications. Measure the load voltage for three-phase models between L3-L0 using a voltmeter and enter the result using the numeric keys. Press the Menu Right → key prior to entering the decimal value.
	AND	
	<div style="border: 1px solid black; padding: 2px;"> GEN L3-L0 V # CALIB REF ?? </div>	Use the numeric keys to enter the <i>decimal</i> value. Press the Enter key.
	<div style="border: 1px solid black; padding: 2px;"> GEN L3-L0 V # CALIB REF # </div>	Confirms the entry.
	<div style="border: 1px solid black; padding: 2px;"> LOAD VOLTAGE LN </div>	Returns the user to the load voltage line-to-neutral voltage heading.
	<div style="border: 1px solid black; padding: 2px;"> RESTORE DEFAULTS? Y/N </div>	Displays the restore defaults selection.
	<div style="border: 1px solid black; padding: 2px;"> RESTORE DEFAULTS? YES </div>	When required, enter YES to activate the restore calibration defaults setting. Press the Enter key. Note: Entering Yes will delete all of the previously entered voltage and current data based on system voltage and kW and restore the calibration default settings.
	<div style="border: 1px solid black; padding: 2px;"> RESTORE DEFAULTS? Y/N </div>	Confirms the entry.
	<div style="border: 1px solid black; padding: 2px;"> GEN VOLTAGE LN </div>	Returns the user to the generator set voltage line-to-neutral heading.

Menu 12—Calibration, continued

Menu 12 Displays with Key Entries (Scale Aux. Analog Inputs)

No calibration is available for inputs A01–A02 for non-ECM engines. No calibration is available for inputs A01–A04 for Waukesha engines.

Key Entry	Display	Description
	ENTER MENU NO. 1-15	Input a menu number.
	MAIN MENU NUMBER 12	Press the Enter key.
	MENU 12 CALIBRATION	Displays the menu number and name.
	SCALE AC ANALOG INPUTS	Displays the scale AC analog inputs heading.
	SCALE AUX. ANALOG INPUTS →	Displays the scale auxiliary analog inputs heading.
	ZERO AUX. ANALOG INPUTS?	Gives the user the option to calibrate the auxiliary analog inputs for zero input signals. Note: ECM engines have inputs A01–A07 and non-ECM engines have inputs A03–A07. A07 may be used for analog voltage adjust. Waukesha engines have inputs A05– A07.
	ZERO AUX. ANALOG INPUTS? YES	When required, enter YES to activate the auto-zero auxiliary analog inputs feature. Press the Enter key.
	ZERO AUX. ANALOG INPUTS? YES	Confirms the entry.
	ANALOG 01 # SCALE VALUE 1 ?	Displays the analog 01 and scale value 1 settings. Use the numeric keys to enter the minimum value based on the previously calculated 5 VDC analog input value.
	SCAL 1 #-#. #V SCAL 2 #-#. #V	Note: Press the Menu Right → key to review both the scale value 1 and scale value 2 settings any time during the setup procedure.
	ANALOG 01 # SCALE VALUE 2 ?	Displays analog 01 and scale value 2 settings. Use the numeric keys to enter the maximum value based on the previously calculated 5 VDC analog value.
	SCALE AUX. ANALOG INPUTS →	Returns the user to the scale auxiliary analog inputs heading.
	ZERO AUX. ANALOG INPUTS?	Press the down arrow to go to the desired analog XX.
	ANALOG XX # SCALE VALUE 1 ?	Displays scale auxiliary analog inputs 01 to 07. Note: Press the down arrow to scroll through the additional analog auxiliary inputs 02–07. Note: Press the down arrow to scroll through the additional analog scale value 1 and value 2 for each analog selection. Note: Press the right arrow at each analog auxiliary input that provides display of the scale 1 and scale 2 voltage settings.

2.9.13 Menu 13—Communications

Menu 13 enables communication with the controller for monitoring or controlling the generator set. KBUS allows a variety of connection types while Modbus® follows Modbus® RTU protocols. Use the LAN (local area network) to gain remote access to multiple devices/addresses. Use the KBUS enable *local* programming mode to edit displays in this menu. Use the monitor software operation manual when accessing this menu, programming from a remote location, and determining address and system identification information.

The user must enable the programming mode to edit the display.

See Section 2.7 for descriptions of the different types of connections.

Modbus® is a registered trademark of Schneider Electric.

The user must enable local programming to make changes in Menu 13; see Section 2.9.14. After the communications settings have been appropriately entered, set the programming mode to REMOTE to utilize remote programming.

Menu 13—Communications

Menu 13 Displays with Key Entries















Key Entry	Display	Description
RESET MENU	ENTER MENU NO. 1-15	Input a menu number.
1 3	MAIN MENU NUMBER 13	Press the Enter key.
ENTER	MENU 13 COMMUNICATIONS	Displays the menu number and name.
MENU	PROTOCOL KBUS →	Displays the KBUS protocol heading.
MENU	KBUS ONLINE Y/N	Displays the KBUS online selection.

7 YES	KBUS ONLINE NO	Entering YES activates the online KBUS selection.
	KBUS ONLINE YES	Press the Enter key.
ENTER	KBUS ONLINE YES	Confirms the entry.

OR		
8 NO	KBUS ONLINE YES	Entering NO deactivates the online KBUS selection.
	KBUS ONLINE NO	Press the Enter key.
ENTER	KBUS ONLINE NO	Confirms the entry.

Menu 13—Communications, continued

Menu 13 Displays with Key Entries

Key Entry	Display	Description																					
	<table border="1"> <tr> <td>CONNECTION TYPE (USER DEFINED)</td> <td>→</td> <td>Y/N</td> </tr> </table>	CONNECTION TYPE (USER DEFINED)	→	Y/N	Displays the user-defined connection type. Press the Down arrow key if the correct connection type is displayed. If the desired connection type is not displayed, press the Right arrow key until the desired connection type appears.																		
CONNECTION TYPE (USER DEFINED)	→	Y/N																					
	<table border="1"> <tr> <td colspan="3">CONNECTION TYPES</td> </tr> <tr> <td>LOCAL SINGLE</td> <td></td> <td>Y/N</td> </tr> <tr> <td>LOCAL LAN</td> <td></td> <td>N/Y</td> </tr> <tr> <td>LOCAL LAN CONV</td> <td></td> <td>N/Y</td> </tr> <tr> <td>REMOTE SINGLE</td> <td></td> <td>N/Y</td> </tr> <tr> <td>REMOTE LAN</td> <td></td> <td>N/Y</td> </tr> <tr> <td>REMOTE LAN CONV</td> <td></td> <td>N/Y</td> </tr> </table>	CONNECTION TYPES			LOCAL SINGLE		Y/N	LOCAL LAN		N/Y	LOCAL LAN CONV		N/Y	REMOTE SINGLE		N/Y	REMOTE LAN		N/Y	REMOTE LAN CONV		N/Y	Entering YES selects the connection type shown. Note: Selecting one connection type deselects any previously selected choice.
CONNECTION TYPES																							
LOCAL SINGLE		Y/N																					
LOCAL LAN		N/Y																					
LOCAL LAN CONV		N/Y																					
REMOTE SINGLE		N/Y																					
REMOTE LAN		N/Y																					
REMOTE LAN CONV		N/Y																					
<hr/>																							
	<table border="1"> <tr> <td>CONNECTION TYPE (USER DEFINED)</td> <td>→</td> <td>YES</td> </tr> </table>	CONNECTION TYPE (USER DEFINED)	→	YES	Press the Enter key.																		
CONNECTION TYPE (USER DEFINED)	→	YES																					
	<table border="1"> <tr> <td>CONNECTION TYPE (USER DEFINED)</td> <td>→</td> <td>YES</td> </tr> </table>	CONNECTION TYPE (USER DEFINED)	→	YES	Confirms the entry.																		
CONNECTION TYPE (USER DEFINED)	→	YES																					
<hr/>																							
	<table border="1"> <tr> <td>PRIMARY PORT (USER DEFINED)</td> <td>→</td> <td>Y/N</td> </tr> </table>	PRIMARY PORT (USER DEFINED)	→	Y/N	Displays the user-defined primary port subheading. Press the Down arrow key if the correct primary port type is displayed. If the desired primary port type is not displayed, press the Right arrow key until the desired primary port type appears.																		
PRIMARY PORT (USER DEFINED)	→	Y/N																					
	<table border="1"> <tr> <td colspan="3">PRIMARY PORTS</td> </tr> <tr> <td>RS-232</td> <td></td> <td>Y/N</td> </tr> <tr> <td>RS-485 ISO 1</td> <td></td> <td>N/Y</td> </tr> </table>	PRIMARY PORTS			RS-232		Y/N	RS-485 ISO 1		N/Y	Entering YES selects the primary port shown. Note: Selecting one primary port deselects any previously selected choice.												
PRIMARY PORTS																							
RS-232		Y/N																					
RS-485 ISO 1		N/Y																					
<hr/>																							
	<table border="1"> <tr> <td>PRIMARY PORT (USER DEFINED)</td> <td>→</td> <td>YES</td> </tr> </table>	PRIMARY PORT (USER DEFINED)	→	YES	Press the Enter key.																		
PRIMARY PORT (USER DEFINED)	→	YES																					
	<table border="1"> <tr> <td>PRIMARY PORT (USER DEFINED)</td> <td>→</td> <td>YES</td> </tr> </table>	PRIMARY PORT (USER DEFINED)	→	YES	Confirms the entry.																		
PRIMARY PORT (USER DEFINED)	→	YES																					
<hr/>																							
	<table border="1"> <tr> <td>ADDRESS (LAN Connections)</td> <td></td> <td>?</td> </tr> </table>	ADDRESS (LAN Connections)		?	Displays the LAN connection address number. Use the numeric keys to enter the desired address 1–128. Use one address number per unit and use consecutive numbers. Individual addresses are necessary for the software to call up the desired unit.																		
ADDRESS (LAN Connections)		?																					
	<table border="1"> <tr> <td>ADDRESS (LAN Connections)</td> <td></td> <td>#</td> </tr> </table>	ADDRESS (LAN Connections)		#	Confirms the entry.																		
ADDRESS (LAN Connections)		#																					
	<table border="1"> <tr> <td>SYSTEM ID (Remote Connections)</td> <td></td> <td>?</td> </tr> </table>	SYSTEM ID (Remote Connections)		?	Displays the system ID request. Use the numeric keys to enter the required system ID of remote connections. The system ID is a password. The user must use the same password for all devices at a site.																		
SYSTEM ID (Remote Connections)		?																					
	<table border="1"> <tr> <td>SYSTEM ID (Remote Connections)</td> <td></td> <td>#</td> </tr> </table>	SYSTEM ID (Remote Connections)		#	Confirms the entry.																		
SYSTEM ID (Remote Connections)		#																					
	<table border="1"> <tr> <td>BAUD RATE (USER DEFINED)</td> <td>→</td> <td>Y/N</td> </tr> </table>	BAUD RATE (USER DEFINED)	→	Y/N	Displays the user-defined baud rate selection. Press the Down arrow key if the correct baud rate is displayed. If the desired baud rate is not displayed, press the Right arrow key until the desired baud rate appears.																		
BAUD RATE (USER DEFINED)	→	Y/N																					
	<table border="1"> <tr> <td colspan="3">BAUD RATES</td> </tr> <tr> <td>1200</td> <td></td> <td>Y/N</td> </tr> <tr> <td>2400</td> <td></td> <td>N/Y</td> </tr> <tr> <td>9600</td> <td></td> <td>N/Y</td> </tr> </table>	BAUD RATES			1200		Y/N	2400		N/Y	9600		N/Y	Entering YES selects the baud rate shown. Note: Selecting one baud rate deselects any previously selected choice.									
BAUD RATES																							
1200		Y/N																					
2400		N/Y																					
9600		N/Y																					

Menu 13—Communications, continued

Menu 13 Displays with Key Entries













Key Entry	Display	Description
7 YES	BAUD RATE (USER DEFINED) → YES	Press the Enter key.
ENTER ←	BAUD RATE (USER DEFINED) → YES	Confirms the entry.
MENU ↓	MENU 13 COMMUNICATIONS	Returns the user to the menu number and name.
MENU ↓	PROTOCOL KBUS →	Returns the user to KBUS protocol heading.
MENU →	PROTOCOL MODBUS 0 →	Displays the Modbus protocol heading.
MENU ↓	MODBUS ONLINE Y/N	Displays the Modbus online selection (yes or no).
7 YES	MODBUS ONLINE NO	Entering YES activates the online Modbus selection.
ENTER ←	MODBUS ONLINE YES	Press the Enter key.
ENTER ←	MODBUS ONLINE YES	Confirms the entry.
OR	MODBUS ONLINE YES	Entering NO deactivates the online Modbus selection.
8 NO	MODBUS ONLINE NO	Press the Enter key.
ENTER ←	MODBUS ONLINE NO	Confirms the entry.
MENU ↓	CONNECTION TYPE (USER DEFINED) → Y/N	Displays the user-defined connection types. Press the Down arrow key if the correct connection type is displayed. If the desired connection type is not displayed, press the Right arrow key until the desired connection type appears.
MENU →	CONNECTION TYPES SINGLE Y/N CONVERTOR N/Y	Entering YES selects the connection type shown. Note: Selecting one connection type deselects any previously selected choice.
7 YES	CONNECTION TYPE (USER DEFINED) → YES	Press the Enter key.
ENTER ←	CONNECTION TYPE (USER DEFINED) → YES	Confirms the entry.
MENU ↓	PRIMARY PORT (USER DEFINED) → Y/N	Displays the user-defined primary ports. Press the Down arrow if the correct primary port is displayed. If the desired primary port is not displayed, press the Right arrow key until the desired primary port appears.
MENU →	PRIMARY PORTS RS-232 (P18) (SINGLE) Y/N RS-485 (P20) (MULTIPLE) N/Y	Entering YES selects the primary port shown. Note: Selecting one primary port deselects any previously selected choice.

Menu 13—Communications, continued

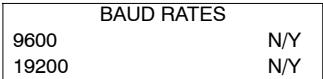
Menu 13 Displays with Key Entries

Key Entry	Display	Description
	PRIMARY PORT (USER DEFINED) → YES	Press the Enter key.
	PRIMARY PORT (USER DEFINED) → YES	Confirms the entry.
	ADDRESS (LAN Connections) ?	Displays the LAN connection address number. Use the numeric keys to enter the desired address 1–128. Use one address number per unit and use consecutive numbers. Individual addresses are necessary for the software to call up the desired unit.
	ADDRESS (LAN Connections) #	Confirms the entry.
	BAUD RATE (USER DEFINED) → Y/N	Displays the user-defined baud rate. Press the Down arrow key if the correct baud rate is displayed. If the desired baud rate is not displayed, press the Right arrow key until the desired baud rate appears.
	BAUD RATES 9600 N/Y 19200 N/Y	Entering YES selects the baud rate shown. Note: Selecting one baud rate deselects any previously selected choice.
	PROTOCOL MODBUS 0 →	Returns the user to protocol Modbus 0 heading.

Key Entry	Display	Description
MENU ↓	MENU 13 COMMUNICATIONS	Returns the user to the menu number and name.
MENU ↓	PROTOCOL KBUS →	Returns the user to KBUS protocol heading.
MENU →	PROTOCOL MODBUS 1 →	Displays the Modbus protocol heading.
MENU ↓	MODBUS ONLINE Y/N	Displays the Modbus online selection (yes or no).
<hr/>		
	MODBUS ONLINE NO	Entering YES activates the online Modbus selection.
7 YES	MODBUS ONLINE YES	Press the Enter key.
ENTER ↵	MODBUS ONLINE YES	Confirms the entry.
<hr/>		
	OR MODBUS ONLINE YES	Entering NO deactivates the online Modbus selection.
8 NO	MODBUS ONLINE NO	Press the Enter key.
ENTER ↵	MODBUS ONLINE NO	Confirms the entry.
<hr/>		
MENU ↓	CONNECTION TYPE (USER DEFINED) Y/N →	Displays the user-defined connection types. Press the Down arrow key if the correct connection type is displayed. If the desired connection type is not displayed, press the Right arrow key until the desired connection type appears.
MENU →	CONNECTION TYPES SINGLE Y/N CONVERTOR N/Y	Entering YES selects the connection type shown. Choices are a single or RS-232 to RS-485 convertor. Note: Selecting one connection type deselects any previously selected choice.
<hr/>		
7 YES	CONNECTION TYPE (USER DEFINED) YES →	Press the Enter key.
ENTER ↵	CONNECTION TYPE (USER DEFINED) YES →	Confirms the entry.
<hr/>		
MENU ↓	PRIMARY PORT RS-458 ISO (P19) Y/N →	Displays the RS-485 ISO (P19) primary port. Press the YES button to select the RS-485 ISO (P19) primary port.
7 YES	PRIMARY PORT RS-458 ISO (P19) YES →	Press the Enter key.
ENTER ↵	PRIMARY PORT RS-458 ISO (P19) Y/N →	Confirms the entry.

Key Entry	Display	Description
		Displays the address number. Use the numeric keys to enter the desired address 1-128. Use one address number per unit and use consecutive numbers. Individual addresses are necessary for the software to call up the desired unit.
		Confirms the entry.
		Displays the user-defined baud rate. Press the Down arrow key if the correct baud rate is displayed. If the desired baud rate is not displayed, press the Right arrow key until the desired baud rate appears.
		Entering YES selects the baud rate shown. Note: Selecting one baud rate deselects any previously selected choice.
<hr style="border-top: 1px dashed black;"/>		
		Press the Enter key.
		Confirms the entry.
<hr style="border-top: 1px dashed black;"/>		
		Returns the user to protocol Modbus 1 heading.

2.9.14 Menu 14—Programming Mode

Menu 14 allows altering controller data either locally using the keypad or remotely using a PC or other device.

The user must enter a password (access code) to enable the programming mode.

Local Programming. Local programming is data alteration using the controller keypad and display.

Remote Programming. Remote programming is data alteration using devices connected to a communication port using KBUS or Modbus® including Monitor III software.

Note: Log into the *local* programming mode to edit the programming access code. *The factory default access code is the number 0.*

Use Menu 14 to change the access code. Record the new number and give the access code to authorized individuals only. Should the controller logic not accept the access code or if the new code number is lost, contact your local authorized distributor/dealer for password information.

The user chooses one of three programming modes:

- Local—using the controller keypad
- Remote—using a PC
- Off—no programming is permitted

Enter Yes to one mode to change the other two choices to No.















Note: Use the generator set controller to initially set up remote programming. Remote programming is not allowed from a PC unless the controller is first set for remote programming using Menu 14.

Note: After completing the programming always *place the controller back in the Programming Mode Off position* to prevent inadvertent program changes.

Modbus® is a registered trademark of Schneider Electric.

Menu 14—Programming Mode, continued

Menu 14 Displays with Key Entries

Key Entry	Display	Description
	ENTER MENU NO. 1-15	Input a menu number.
 	MAIN MENU NUMBER 14	Press the Enter key.
	MENU 14 PROGRAMMING MODE	Displays the menu number and name.
	PROGRAMMING MODE → (USER DEFINED) Y/N	Displays the user-defined programming mode. Press the Down arrow key if the correct programming mode is displayed. If the desired programming mode is not displayed, press the Right arrow key until the desired programming mode appears.
	PROGRAMMING MODES OFF Y/N LOCAL N/Y REMOTE N/Y	Entering YES selects the programming mode shown. Note: Selecting one programming mode deselects any previously selected choice.
	PROGRAMMING MODE → (USER DEFINED) YES	Press the Enter key.
	PROGRAMMING MODE ENTER CODE *	Changing the programming mode requires entering the access code. Enter the access code and press the Enter key. Note: The factory default access code is the number 0.
	PROGRAMMING MODE → (USER DEFINED) YES	Confirms the entry.
	PROGRAMMING MODE → CHANGE ACCESS CODE	Displays the programming mode and changes the access code. Press the Down arrow key if you do not wish to change the access code. To change the access code, press the Right arrow key.
	PROGRAMMING MODE ENTER OLD CODE *	Enter the old access code and press the Enter key.
	PROGRAMMING MODE ENTER NEW CODE *	Enter the new access code and press the Enter key.
	PROGRAMMING MODE → CHANGE ACCESS CODE	Confirms the entry.
	MENU 14 PROGRAMMING MODE	Returns the user to the programming mode heading.

2.9.15 Menu 15—Protective Relays (PR)

Menu 15 provides the necessary protective relays for units with the optional paralleling protection feature. If

the generator set personality profile did not include the paralleling option this menu will not appear on the display. Available with PD-Series switchgear only.





















Menu 15—Protective Relays

Menu 15 Displays with Key Entries

Key Entry	Display	Description
	ENTER MENU NO. 1-15	Input a menu number.
	MAIN MENU NUMBER 15	Press the Enter key.
	MENU 15 PROTECTIVE RELAYS	Displays the menu number and name.
	PR OVERVOLTAGE → ?% #VAC	Displays the overvoltage % value. When required, use the numeric keys to enter the desired overvoltage % value and press the Enter key.
	PR OVERVOLTAGE → #% #VAC	Displays the corrected overvoltage % value.
	TIME DELAY → ?SEC	Displays the overvoltage time delay. When required, use the numeric keys to enter the desired time delay value and press the Enter key.
	TIME DELAY → #SEC	Displays the corrected overvoltage time delay value.
	PR OVERVOLTAGE → ?% #VAC	Returns the user to the overvoltage % value display.
	PR UNDERVOLTAGE → ?% #VAC	Displays the undervoltage % value. When required, use the numeric keys to enter the desired undervoltage % value and press the Enter key.
	PR UNDERVOLTAGE → #% #VAC	Displays the corrected undervoltage % value.
	TIME DELAY → ?SEC	Displays the undervoltage time delay. When required, use the numeric keys to enter the desired time delay value and press the Enter key.
	TIME DELAY → #SEC	Displays the corrected undervoltage time delay value.
	PR UNDERVOLTAGE → ?% #VAC	Returns the user to the undervoltage % value display.
	PR OVERFREQUENCY → ?% #HZ	Displays the overfrequency % value. When required, use the numeric keys to enter the desired overfrequency % value and press the Enter key.
	PR OVERFREQUENCY → #% #HZ	Displays the corrected overfrequency % value.
	TIME DELAY → ?SEC	Displays the overfrequency time delay. When required, use the numeric keys to enter the desired time delay value and press the Enter key.
	TIME DELAY → #SEC	Displays the corrected overfrequency time delay value.
	PR OVERFREQUENCY → ?% #VAC	Returns the user to the overfrequency % value display.





















Menu 15—Protective Relays, continued

Menu 15 Displays with Key Entries

Key Entry	Display	Description
	PR UNDERFREQUENCY → ?% #HZ	Displays the underfrequency % value. When required, use the numeric keys to enter the desired underfrequency % value and press the Enter key.
	PR UNDERFREQUENCY → #% #HZ	Displays the corrected underfrequency % value.
	TIME DELAY → ?SEC	Displays the underfrequency time delay. When required, use the numeric keys to enter the desired time delay value and press the Enter key.
	TIME DELAY → #SEC	Displays the corrected underfrequency time delay value.
	PR UNDERFREQUENCY → ?% #HZ	Returns the user to the underfrequency % value display.
	PR REVERSE POWER → ?% #KW	Displays the reverse power % value. When required, use the numeric keys to enter the desired reverse power % value and press the Enter key.
	PR REVERSE POWER → #% #KW	Displays the corrected reverse power % value.
	TIME DELAY → ?SEC	Displays the reverse power time delay. When required, use the numeric keys to enter the desired time delay value and press the Enter key.
	TIME DELAY → #SEC	Displays the corrected reverse power time delay value.
	PR REVERSE POWER → ?% #KW	Returns the user to the reverse power % value display.
	SD REVERSE POWER → ?% #KW	Displays the reverse power shutdown % value. When required, use the numeric keys to enter the desired reverse power shutdown % value and press the Enter key.
	SD REVERSE POWER → #% #KW	Displays the corrected reverse power shutdown % value.
	TIME DELAY → ?SEC	Displays the reverse power shutdown time delay. When required, use the numeric keys to enter the desired time delay value and press the Enter key.
	TIME DELAY → #SEC	Displays the corrected reverse power shutdown time delay value.
	SD REVERSE POWER → ?% #KW	Returns the user to the reverse power shutdown % value display.
	PR OVER POWER → ?% #KW	Displays the over power % value. When required, use the numeric keys to enter the desired over power % value and press the Enter key.
	PR OVER POWER → #% #KW	Displays the corrected over power % value.
	TIME DELAY → ?SEC	Displays the over power time delay. When required, use the numeric keys to enter the desired time delay value and press the Enter key.
	TIME DELAY → #SEC	Displays the corrected over power time delay value.
	PR OVER POWER → ?% #KW	Returns the user to the over power % value display.















Menu 15—Protective Relays, continued

Menu 15 Displays with Key Entries

Key Entry	Display	Description
	SD OVER POWER → ?% #KW	Displays the over power shutdown % value. When required, use the numeric keys to enter the desired over power shutdown % value and press the Enter key.
	SD OVER POWER → #% #KW	Displays the corrected over power shutdown % value.
	TIME DELAY → ?SEC	Displays the over power shutdown time delay. When required, use the numeric keys to enter the desired time delay value and press the Enter key.
	TIME DELAY → #SEC	Displays the corrected over power shutdown time delay value.
	SD OVER POWER → ?% #KW	Returns the user to the over power shutdown % value display.
	PR LOSS OF FIELD → ?% #KVAR	Displays the loss of field % value. When required, use the numeric keys to enter the desired loss of field % value and press the Enter key.
	PR LOSS OF FIELD → #% #KVAR	Displays the corrected loss of field % value.
	TIME DELAY → ?SEC	Displays the loss of field time delay. When required, use the numeric keys to enter the desired time delay value and press the Enter key.
	TIME DELAY → #SEC	Displays the corrected loss of field time delay value.
	PR LOSS OF FIELD → ?% #KVAR	Returns the user to the loss of field % value display.
	SD LOSS OF FIELD → ?% #KVAR	Displays the loss of field shutdown % value. When required, use the numeric keys to enter the desired loss of field % value and press the Enter key.
	SD LOSS OF FIELD → #% #KVAR	Displays the corrected loss of field shutdown % value.
	TIME DELAY → ?SEC	Displays the loss of field shutdown time delay. When required, use the numeric keys to enter the desired time delay value and press the Enter key.
	TIME DELAY → #SEC	Displays the corrected loss of field shutdown time delay value.
	SD LOSS OF FIELD → ?% #KVAR	Returns the user to the loss of field shutdown % value display.
	PR OVERCURRENT VR → ?% #AMPS	Displays the over current with voltage restraint (VR) % value. When required, use the numeric keys to enter the desired over current % value and press the Enter key.
	PR OVERCURRENT VR → #% #AMPS	Displays the corrected over current % value.
	TIME DELAY → ?SEC	Displays the over current time delay. When required, use the numeric keys to enter the desired time delay value and press the Enter key.
	TIME DELAY → #SEC	Displays the corrected over current time delay value.
	PR OVERCURRENT VR → ?% #AMPS	Returns the user to the over current % value display.

Menu 15—Protective Relays, continued

Menu 15 Displays with Key Entries

Key Entry	Display	Description
	SD OVER CURRENT VR → ?% #AMPS	Displays the over current shutdown with voltage restraint (VR) % value. When required, use the numeric keys to enter the desired over current shutdown % value and press the Enter key.
	SD OVER CURRENT VR → #% #AMPS	Displays the corrected over current shutdown % value.
	TIME DELAY → ?SEC	Displays the over current shutdown time delay. When required, use the numeric keys to enter the desired time delay value and press the Enter key.
	TIME DELAY → #SEC	Displays the corrected over current shutdown time delay value.
	SD OVER CURRENT VR → ?% #AMPS	Returns the user to the over current shutdown % value display.
	SYNC VOLTAGE MATCH → ? VAC	Displays the synchronization matching voltage value. When required, use the numeric keys to enter the desired synchronization matching voltage value and press the Enter key.
	SYNC VOLTAGE MATCH → # VAC	Displays the corrected synchronization matching voltage value.
	SYNC FREQ MATCH → ? HZ	Displays the synchronization matching frequency value. When required, use the numeric keys to enter the desired synchronization matching frequency value and press the Enter key.
	SYNC FREQ MATCH → # HZ	Displays the corrected synchronization matching frequency value.
	SYNC PHASE MATCH → ? DEG	Displays the synchronization matching phase value. When required, use the numeric keys to enter the desired synchronization matching phase value and press the Enter key.
	SYNC FREQ MATCH → # DEG	Displays the corrected synchronization matching phase value.
	TIME DELAY → ?SEC	Displays the synchronization time delay. When required, use the numeric keys to enter the desired time delay value and press the Enter key.
	TIME DELAY → #SEC	Displays the corrected synchronization time delay value.
	SYNC VOLTAGE MATCH → ? VAC	Returns the user to the synchronization matching voltage value display.

2.9.16 Menu 18—Battery Chargers

⚠ WARNING

<p>Explosion. Can cause severe injury or death. Relays in the battery charger cause arcs or sparks.</p> <p>Locate the battery in a well-ventilated area. Isolate the battery charger from explosive fumes.</p>

Battery gases. Explosion can cause severe injury or death. Incorrect use of the equalize charge state may lead to hazardous situations. Equalization is ONLY applicable for flooded lead acid (FLA) type batteries and will damage gel, absorbed glass mat (AGM), or nickel-cadmium (NiCad) type batteries. In the controller menu or SiteTech™ settings, verify that the battery topology is set correctly for the battery type used. Do not smoke or permit flames, sparks, or other sources of ignition to occur near a battery at any time.

Menu 18 provides battery charger information and parameter settings for GM87448, 10 amp battery charger. Use this menu to view battery charger metering information, charge state and identify the battery charger software version as well as to configure the battery charger parameters.

Note: This menu is only available for controller firmware version 3.4.3 and above.

Refer to the Battery Charger Operation Manual for charger settings, operation instructions, and safety information.

Note: Incorrect charger output system voltage may cause irreversible damage to the battery and abnormal out gassing. Ensure that the battery charger parameters match the battery manufacturer's specifications before using. In the controller user interface settings, verify that the battery topology and system voltage is set correctly for the battery type that is used.

Note: The battery charger menus are designed to work with charger GM87448. Unless connected to charger GM87448 through CAN communication, the battery charger menus, although visible, have no effect on the battery charger.











Menu 18—Battery Chargers

Menu 18 Displays with Key Entries

Key Entry	Display	Description
RESET MENU	ENTER MENU NO. 1-15	Input a menu number.
1 8 NO	MAIN MENU NUMBER 18	Press the Enter key.
ENTER	MENU 18 BATTERY CHARGERS	Displays the menu number and name.
MENU	BATTERY CHARGER 1 → BATTERY CHARGER 2 →	Allows the selection of the battery charger.
MENU	BATTERY CHARGER METERING → BATTERY CHARGER BASIC CONFIG → BATTERY CHARGER ADVANCED CONFIG	
MENU	OUTPUT VOLTAGE # OUTPUT CURRENT #	Displays the battery charger output voltage and output current.
MENU	CHARGER STATE #	Displays the charging state that the battery charger has entered such as recovery, bulk, absorption, float, equalize.
MENU	SFWR VER #	Displays the battery charger firmware version.
MENU	REDUCED OUTPUT Y/N TEMP COMP ACTIVE Y/N	Displays whether reduced output and temperature compensation are enabled.
MENU	BATTERY CHARGER 1	Returns the user to the Battery Charger 1 or 2 heading.

Menu 18—Battery Chargers

Menu 18 Displays with Key Entries

Key Entry	Display	Description
	BATTERY CHARGER 1	Returns the user to the battery charger selection menu.
	BATTERY CHARGER METERING	Returns the user to the Battery Charger Metering menu.
	BATTERY CHARGER BASIC CONFIG	Displays the Battery Charger Basic Configuration menu.
	1-BATTERY TOPOLOGY → (User Defined) Y/N	Displays the user-defined battery topology. Press the Down arrow key if the correct battery topology is displayed. If the desired battery topology is not displayed, press the Right arrow key until the desired battery topology appears.
	BATTERY TOPOLOGIES Default Y/N FLA/VRLA N/Y AGM N/Y Gel N/Y NiCad N/Y	
	BATTERY TOPOLOGY → (User Defined) YES	Press the Enter key.
	BATTERY TOPOLOGY → (User Defined) YES	Confirms the entry.
	CHARGER SYSTEM VOLTAGE → (user Defined) Y/N	Displays the user-defined system voltage. Press the Down arrow key if the correct system voltage is displayed. If the desired system voltage is not displayed, press the Right arrow key until the desired system voltage appears.
	SYSTEM VOLTAGES 12V Y/N 24V N/Y	
	BATTERY TOPOLOGY → (User Defined) YES	Press the Enter key.
	BATTERY TOPOLOGY → (User Defined) YES	Confirms the entry.

Menu 18—Battery Chargers, Continued

Menu 18 Displays with Key Entries

Key Entry	Display	Description
MENU ▼	AUTOMATIC EQUALIZE ENABLED Y/N	Enable equalization charge state. Note: Equalization is ONLY applicable for flooded lead acid (FLA or VRLA in the menu) type batteries and will damage gel, absorbed glass mat (AGM), or nickel-cadmium (NiCad) type batteries.
7 YES	AUTOMATIC EQUALIZE NO	Entering YES activates the Equalize selection.
ENTER ↵	AUTOMATIC EQUALIZE YES	Press the Enter key.
ENTER ↵	AUTOMATIC EQUALIZE YES	Confirms the entry.
	OR	
8 NO	AUTOMATIC EQUALIZE YES	Entering NO deactivates the Equalize selection.
ENTER ↵	AUTOMATIC EQUALIZE NO	Press the Enter key.
ENTER ↵	AUTOMATIC EQUALIZE NO	Confirms the entry.
<hr style="border-top: 1px dashed black;"/>		
MENU ▼	TEMP COMPENSATION ENABLED Y/N	Entering YES activates the Temperature Compensation selection.
7 YES	TEMP COMPENSATION NO	Press the Enter key.
ENTER ↵	TEMP COMPENSATION YES	Press the Enter key.
ENTER ↵	TEMP COMPENSATION YES	Confirms the entry.
	OR	
8 NO	TEMP COMPENSATION YES	Entering NO deactivates the Temperature Compensation selection.
ENTER ↵	TEMP COMPENSATION NO	Press the Enter key.
ENTER ↵	TEMP COMPENSATION NO	Confirms the entry.
<hr style="border-top: 1px dashed black;"/>		
MENU ▼	ABSORPTION TERMINATION ????A	Use the key pad to enter the limit to determine when the absorption charge state completes.
ENTER ↵	ABSORPTION TERMINATION #.###A	Confirms the entry.
MENU ▼	BATTERY CHARGER 1	Returns the user to the Battery Charger 1 heading.

Menu 18—Battery Chargers, Continued

Menu 18 Displays with Key Entries

Key Entry	Display	Description
MENU ↓	BATTERY CHARGER 1	Returns the user to the battery charger selection menu.
MENU →	BATTERY CHARGER METERING	Returns the user to the Battery Charger Metering menu.
MENU →	BATTERY CHARGER BASIC CONFIGURATION	Displays the Battery Charger Basic Configuration menu.
MENU ↓	BATTERY CHARGER ADVANCED CONFIG	Displays the Battery Charger Advanced Configuration menu.
MENU ↓	CUSTOMER CHARGING PROFILE ENABLE Y/N	Enables a customized battery charger profile. Note: ONLY adjust parameters outside default to manufacturer recommended values. Maladjustment will result in reduced battery performance and potential harm to the battery.
	CUSTOMER CHARGING NO	Entering YES activates the Customer Charging selection.
7 YES	CUSTOMER CHARGING YES	Press the Enter key.
ENTER ↵	CUSTOMER CHARGING YES	Confirms the entry.
	OR	
	CUSTOMER CHARGING YES	Entering NO deactivates the Customer Charging selection.
8 NO	CUSTOMER CHARGING NO	Press the Enter key.
ENTER ↵	CUSTOMER CHARGING NO	Confirms the entry.
<hr/>		
MENU ↓	BULK VOLTAGE ????VDC	Use the keypad to enter the target bulk voltage setpoint.
ENTER ↵	BULK VOLTAGE #####VDC	Confirms the entry.
<hr/>		
MENU ↓	ABSORPTION VOLTAGE ????VDC	Use the keypad to enter the target absorption voltage setpoint.
ENTER ↵	ABSORPTION VOLTAGE #####VDC	Confirms the entry.
<hr/>		
MENU ↓	FLOAT VOLTAGE ????VDC	Use the keypad to enter the target float voltage setpoint.
ENTER ↵	FLOAT VOLTAGE #####VDC	Confirms the entry.
<hr/>		

Menu 18—Battery Chargers, Continued

Menu 18 Displays with Key Entries

Key Entry	Display	Description
MENU ▼	MANUAL EQUALIZE ACTIVE Y/N	Manual Equalize triggers a single equalize cycle on the next charge cycle. The equalize cycle occurs between the absorption and float cycle.
	MANUAL EQUALIZE ACTIVE NO	Entering YES activates the Manual Equalize selection.
7 YES	MANUAL EQUALIZE ACTIVE YES	Press the Enter key.
ENTER ↵	MANUAL EQUALIZE ACTIVE YES	Confirms the entry.
	OR	
	MANUAL EQUALIZE ACTIVE YES	Entering NO deactivates the Manual Equalize selection.
8 NO	MANUAL EQUALIZE ACTIVE NO	Press the Enter key.
ENTER ↵	MANUAL EQUALIZE ACTIVE NO	Confirms the entry.
<hr/>		
MENU ▼	TEMPERATURE COMP SLOPE -??mV/C	Allows fine adjustment of the amount of temperature compensation to follow an optimal manufacturer's recommendation.
ENTER ↵	TEMPERATURE COMP SLOPE -##mV/C	Confirms the entry.
<hr/>		
MENU ▼	EQUALIZE VOLTAGE ?.??VDC	Use the keypad to enter the target equalize voltage setpoint. Note: Automatic Equalize must be set to enabled.
ENTER ↵	EQUALIZE VOLTAGE #####VDC	Confirms the entry.
<hr/>		
MENU ▼	MAX ABSORPTION TIME ??MIN	Use the keypad to set the maximum amount of time the battery attempts to complete the absorption cycle.
ENTER ↵	MAX ABSORPTION TIME ###MIN	Confirms the entry.
<hr/>		
MENU ▼	MAX BULK TIME ??MIN	Use the keypad to set the maximum amount of time the battery attempts to complete the bulk cycle.
ENTER ↵	MAX BULK TIME ###MIN	Confirms the entry.
<hr/>		
MENU ▼	BULK STATE RETURN VOLTAGE ?.??V	Use the keypad to enter the measured battery terminal voltage at which the charger will initiate a charge cycle at bulk.
ENTER ↵	BULK STATE RETURN VOLTAGE #####V	Confirms the entry.
MENU ▼	BATTERY CHARGER1	Returns the user to the Battery Charger 1 heading.

2.9.17 Menu 20—Factory Setup

Menu 20 provides generator set, alternator, controller, and engine identification information. The user can use this menu to determine the generator set operating days and identify the controller software (code) version. The factory setup menu information is locked by the manufacturer. The temperature sensor setup applies to non-ECM engines only.

Note: This menu is for monitoring only; no adjustments or user settings can be entered.









Note: For Version 2.69 and lower, enter the numeric serial number from the generator set nameplate. For Version 2.70 and higher, confirm that the alphanumeric number shown on the display matches the serial number shown on the generator set nameplate. If the serial numbers match, press the YES key and then press ENTER. If the serial numbers do not match, the wrong personality parameter file is installed. Refer to the Program Loader documentation for instructions on reloading the personality parameter file.

Note: For Version 3.01 and higher, the engine type is displayed for engines with an ECM. The correct engine type is not displayed until the engine has run.

Note: For Version 3.01 and higher, the Low Coolant Temp Warning can be disabled on units with non-ECM engines that are not required to meet NFPA 110. As with older version of firmware on ECM engines, the LCTW may be disabled by selecting NO for the respective Warning Enabled input. Refer to section 2.9.7 for disabling NFPA defaults and refer to section 2.9.9 for configuration of digital inputs.

Menu 20—Factory Setup

Menu 20 Displays with Key Entries

Key Entry	Display	Description
	<input type="text" value="ENTER MENU NO. 1-15"/>	Input a menu number.
 	<input type="text" value="MAIN MENU NUMBER 20"/>	Press the Enter key.
	<input type="text" value="MENU 20
FACTORY SETUP"/>	Displays the menu number and name.
	<input type="text" value="FINAL ASSEMBLY DATE
DD/MM/YY"/>	Displays the final assembly date at the factory.
	<input type="text" value="FINAL ASSEMBLY
CLOCK NO #"/>	Displays the final assembly clock number at the factory.
	<input type="text" value="OPERATING DAYS #"/>	Displays the generator set operating days.
	<input type="text" value="MODEL NO #"/>	Displays the generator set model number.
	<input type="text" value="SPEC NO #"/>	Displays the generator set specification number.

Menu 20—Factory Setup, continued

Menu 20 Displays with Key Entries

Key Entry	Display	Description
MENU ▼	GENSET SERIAL NO #	Displays the generator set serial number.
MENU ▼	ALTERNATOR PART NO #	Displays the alternator part number.
MENU ▼	ENGINE PART NO #	Displays the engine part number.
MENU ▼	TEMP SENSOR YES GM31045-X	<div style="display: flex; align-items: center;"> <div style="border: 1px solid black; padding: 2px; margin-right: 5px;">TEMP SENSOR NO GM16787</div> <div style="margin: 0 5px;">→</div> <div style="border: 1px solid black; padding: 2px;">TEMP SENSOR NO GM17362</div> </div>
MENU ▼	DISABLE LOW COOLANT TEMP WARNING Y/N	Press YES to disable the Low Coolant Temp Warning. Value is only accepted when the warning is not active and NFPA 110 Defaults are not selected.
7 YES	DISABLE LOW COOLANT TEMP WARNING Y/N	Press the Enter key.
MENU ▼	SERIAL NO CONFIRM →	Displays the generator set serial number confirmation display.
MENU ▶	CONFIRM SERIAL? Y/N #####	Press YES, if the display matches the generator set nameplate serial number. Refer to the Menu 20 notes if the serial numbers do not match.
7 YES	CONFIRM SERIAL? YES #####	Press the Enter key.
ENTER ←	SERIAL NO CONFIRM →	Returns user to the Serial No. Confirm display.
MENU ▼	CONTROLLER SERIAL NO #	Displays the controller serial number.
MENU ▼	CODE VERSION # COPYRIGHT XXXX	Displays the controller software (code) version.
MENU ▼	SETUP LOCKED YES	Displays the setup locked by the manufacturer.
MENU ▼	ENGINE TYPE ????????	Displays the engine type.

Notes

Section 3 Scheduled Maintenance

Under normal operating conditions, the generator set's alternator requires no routine service. Consult Section 2.1, Prestart Checklist, for a list of routine checks.

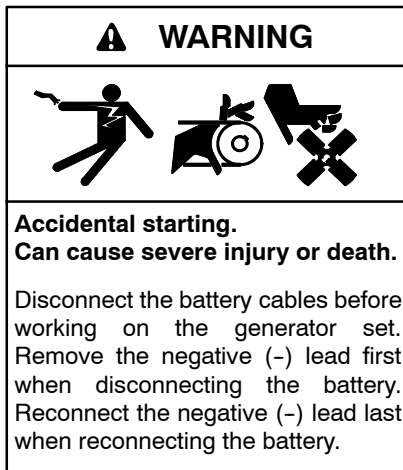

Disabling the generator set. Accidental starting can cause severe injury or death. Before working on the generator set or equipment connected to the set, disable the generator set as follows: (1) Move the generator set master switch to the OFF position. (2) Disconnect the power to the battery charger. (3) Remove the battery cables, negative (-) lead first. Reconnect the negative (-) lead last when reconnecting the battery. Follow these precautions to prevent starting of the generator set by an automatic transfer switch, remote start/stop switch, or engine start command from a remote computer.

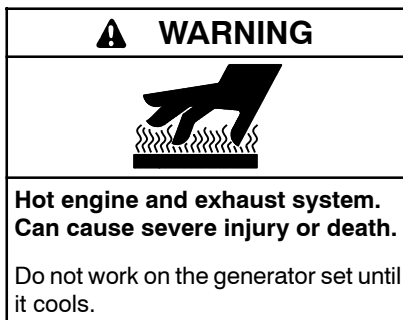

Servicing the exhaust system. Hot parts can cause severe injury or death. Do not touch hot engine parts. The engine and exhaust system components become extremely hot during operation.

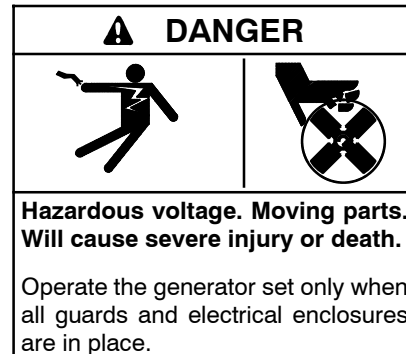

Servicing the generator set when it is operating. Exposed moving parts will cause severe injury or death. Keep hands, feet, hair, clothing, and test leads away from the belts and pulleys when the generator set is running. Replace guards, screens, and covers before operating the generator set.

3.1 Alternator Service

When operating the generator set under dusty or dirty conditions, use dry compressed air to blow dust out of the alternator while the generator set is running. Direct the stream of air through openings in the generator set end bracket.

3.2 Engine Service

Perform engine service at the intervals specified in the engine manufacturer's service literature. Contact an authorized service distributor/dealer to obtain service literature.

Note: Have maintenance work, including battery service, performed by appropriately skilled and suitably trained maintenance personnel familiar with generator set operation and service.

3.3 Service Schedule

System—Component	Action					Interval
	Visually Inspect	Check	Change	Clean	Test	
Fuel System						
Day tank level	X	X				Weekly
Flexible lines and connections	X		R			Weekly
Fuel level switch	X				X	Weekly
Main tank supply level		X				Weekly
Solenoid valve operation	X				X	Weekly
Transfer pump operation	X				X	Weekly
Water in system, remove		•		•		Weekly
Filter(s)			•			Quarterly
Gasoline supply			R			Six Months
Fuel piping	X					Yearly
Tank vents and return lines for obstructions		X				Yearly
Lubrication System						
Oil level	•	•				Weekly
Crankcase breather	•		•			Quarterly
Change oil			•			First 50 Hrs., Then Every 250 Hrs.
Replace filter(s)*			•			
Cooling System						
Radiator fan bolt torque (1500-2800REOZDC, 2500-2800REOZDB, and 3000/3250REOZD with unit-mounted radiator)		X				Initially 8 Hrs., Then Every 100 Hrs.
Air cleaner to room/enclosure		X				Weekly
Block heater operation		X				Weekly
Coolant level	•	•				Weekly
Flexible hoses and connectors	X	X				Weekly
Water pump(s)	•					Weekly
Fan and alternator belts	•	•	R			Monthly
Coolant temperature protection level					•	Six Months
Lubricate fan bearings (1350 kW and larger)	X	X				200 Hrs. or Six Months
Air ducts, louvers		X		X		Yearly
Coolant			•			Yearly
Heat exchanger				X		Yearly
Louver motors and controls	X			X	X	Yearly
Radiator exterior				X		Yearly
Water supply to heat exchanger		X				Yearly
Exhaust System						
Drain condensate trap		X				Weekly
Leakage	X	X				Weekly
Insulation, fire hazards	X					Quarterly
Flexible connector(s)	X					Six Months
Excessive back pressure					X	Yearly
Hangers and supports	X					Yearly
DC Electrical System						
Battery charger operation, charge rate	X					Monthly
Battery electrolyte level		X				Monthly
Battery specific gravity, charge state					X	Monthly
Recharge after engine start		X				Monthly
Remove corrosion, clean and dry battery and rack	X			X		Monthly
Clean and tighten battery terminals	X	X				Quarterly
Tighten DC electrical connections		X				Six Months
<ul style="list-style-type: none"> • Follow procedures and frequencies indicated in the engine manufacturer's maintenance manual. If not indicated, follow this service schedule. Some items may not apply to all generator sets. R Replace as necessary. X Action * Service more frequently if operated in dusty areas. 						

Service Schedule, continued

System—Component	Action					Interval
	Visually Inspect	Check	Change	Clean	Test	
AC Electrical System						
Controller lamp test	X				R	Weekly
General Inspection	X					Weekly
Circuit breakers, fuses†	X	X	R	X	X	Monthly
Wire abrasions where subject to motion	X	X				Quarterly
Safety and alarm operation		X			X	Six Months
Tighten control and power wiring connections		X				Yearly
Transfer switch main contacts†	X			X		Yearly
Voltage-sensing device/relay adjustment†		•			•	Yearly
Wire-cable insulation breakdown	X				X	3 Years or 500 Hrs.
Engine and Mounting						
General inspection	•					Weekly
Governor operation, lubricate moving parts	•	•				Monthly
Air cleaner service		•	•			Six Months
Choke, carburetor adjustment		•				Six Months
Governor oil (mechanical governor only)		•				Yearly
Ignition components	•			•		Yearly
Injector pump and injector flow rate, pressure, spray pattern		•			•	Yearly
Valve clearance		•				3 Years or 500 Hrs.
Bolt torque		•			•	3 Years or 500 Hrs.
Remote Control System, etc.						
Compartment condition	X			X		Weekly
Remote control					X	Monthly
Run generator set					X	Monthly
Alternator						
General inspection	X					Weekly
Rotor and stator	X			X		Yearly
Bearing condition	X	X	R			Yearly
Exciter	X	X		X		Yearly
Voltage regulator	X	X		X		Yearly
Measure and record resistance readings of windings with insulation tester (Megger®, with SCR assembly or rectifier disconnected)					X	Yearly
Blow dust out of alternator*	X			•		2 Years or 300 Hrs.
General Condition of Equipment						
Any condition of vibration, leakage, noise, temperature, or deterioration	X	X		X		Weekly
Ensure that system is set for automatic operation	X					Weekly
Interior of equipment room or outdoor weather housing	X			X		Weekly
<ul style="list-style-type: none"> • Follow procedures and frequencies indicated in the engine manufacturer's maintenance manual. If not indicated, follow this service schedule. Some items may not apply to all generator sets. R Replace as necessary. X Action. * Service more frequently if operated in dusty areas. † Do not break manufacturer's seals or internally inspect these devices. 						

Megger® is a registered trademark of Biddle Instruments.

3.4 Alternator Bearing Service

Have an authorized service distributor/dealer perform service.

3.4.1 20–300 kW Models

Replace the end bracket bearing every 10,000 hours of operation in standby and prime power applications. Service the bearing more frequently if the annual inspection indicates excessive rotor end play or bearing damage. Replace the tolerance ring, if equipped, following end bracket removal. The sealed end bracket bearing requires no additional lubrication.

3.4.2 300–2250 kW Models with Single-Bearing Alternator

The alternator bearing requires lubrication at intervals specified in the generator set technical manual. Use Chevron SRI or equivalent antifriction, high-quality grease with a lubrication temperature range of -30°C to 175°C (-22°F to 350°F).

3.4.3 1250 kW and Larger Models with Two-Bearing Alternator

Refer to the generator set service manual for bearing maintenance information.

3.5 Diesel Fuel Systems

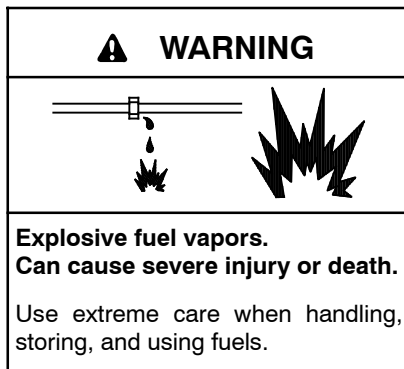

The fuel system. Explosive fuel vapors can cause severe injury or death. Vaporized fuels are highly explosive. Use extreme care when handling and storing fuels. Store fuels in a well-ventilated area away from spark-producing equipment and out of the reach of children. Never add fuel to the tank while the engine is running because spilled fuel may ignite on contact with hot parts or from sparks. Do not smoke or permit flames or sparks to occur near sources of spilled fuel or fuel vapors. Keep the fuel lines and connections tight and in good condition. Do not replace flexible fuel lines with rigid lines. Use flexible sections to avoid fuel line breakage caused by vibration. Do not operate the generator set in the presence of fuel leaks, fuel accumulation, or sparks. Repair fuel systems before resuming generator set operation.

Draining the fuel system. Explosive fuel vapors can cause severe injury or death. Spilled fuel can cause an explosion. Use a container to catch fuel when draining the fuel system. Wipe up spilled fuel after draining the system.

3.5.1 Bleeding Air from Fuel System

Bleed air from the fuel system after fuel system maintenance, such as replacing the fuel filter(s). Use the hand prime pump kit, when equipped. The hand prime fuel pump eliminates the need for cranking the engine to bleed air from the fuel system.

Note: Bleed air from the fuel system according to the engine manufacturer's instructions. Trapped air in the fuel system causes difficult starting and/or erratic engine operation.

Note: Correct any fuel leaks encountered during the priming procedure.

1. Place the fuel valves in the fuel system prime position. Close the fuel valve located between the pipe tee and the engine. Open the fuel valves on each side of the fuel prime pump. See Figure 3-1.

Note: The illustration shows a generator set without a fuel/water separator. The valve location and position for a generator set equipped with a fuel/water separator is similar.

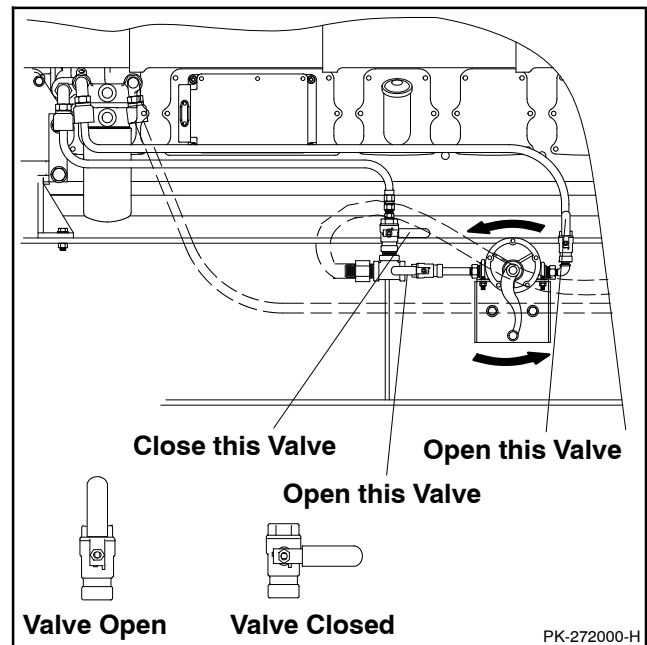

Figure 3-1 Hand Prime Pump with Valve Positions for Fuel Priming (generator set without a fuel/water separator shown), Typical

2. Loosen the bleed screw at the engine. Refer to the engine operation manual for location of the bleed screw(s). The bleed screw allows air to be expelled from the fuel system when the hand prime pump is operated.
3. Rotate the hand prime pump handle counterclockwise until fuel flows from the bleed screw. Stop pumping.
4. Tighten the bleed screw. Wipe up any fuel leakage.
5. Place the fuel valves in the normal operation position. Open the fuel valve located between the pipe tee and the engine. Close the fuel valves on each side of the fuel prime pump.

3.5.2 Subbase Fuel Day Tank Electronic Control Module (ECM)

With an electronic control module (ECM), the optional subbase diesel fuel tank functions as a day tank. Following are operating information and features of the ECM. See Figure 3-2 for the ECM front panel layout.

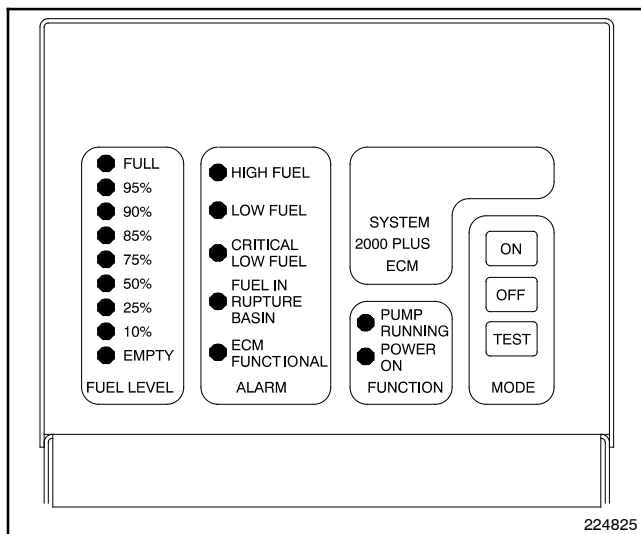

Figure 3-2 ECM Front Panel Layout

Servicing the day tank. Hazardous voltage will cause severe injury or death. Service the day tank electrical control module (ECM) as prescribed in the equipment manual. Disconnect the power to the day tank before servicing. Press the day tank ECM OFF pushbutton to disconnect the power. Notice that line voltage is still present within the ECM when the POWER ON light is lit. Ensure that the generator set and day tank are electrically grounded. Do not operate the day tank when standing in water or on wet ground because these conditions increase the risk of electrocution.

ECM General Function

The ECM controls a pump/motor that maintains the day tank fuel level. The ECM motor relay is connected to the pump/motor. The ECM starts the pump when the fuel level drops to 87% of full and stops the pump when the day tank is full.

ECM Function Indicator LEDs

Two LEDs on the front panel indicate ECM operation. See Figure 3-2 for the locations of the LEDs. Figure 3-3 describes the LED functions.

Function	Description
Power On	LED lights to indicate that power is applied to the ECM.
Pump Running	LED lights when the pump starts.

Figure 3-3 ECM Function Indicator LEDs

Level Sensor

An electronic analog float gauge located below the ECM on the mounting bracket determines the day tank fuel level. Nine LEDs on the ECM indicate the day tank fuel level from full to empty.

ECM Mode

The ECM has three pushbutton switches for normal operation and one internal test button. See Figure 3-4.

Pushbutton	Description
Off	Pushbutton disables the ECM for routine maintenance to the tank system.
On	Pushbutton activates the ECM after the OFF pushbutton is depressed. On power-up after a power outage, the ECM automatically turns on.
Test	Pushbutton lights front panel LEDs for 3 seconds and activates the pump/motor for as long as the pushbutton is depressed. The alarm relays maintain their original positions.
Internal test	Pushbutton (located inside the ECM) tests each alarm LED and remote annunciation relay in sequential order (high fuel to ECM functional).

Figure 3-4 ECM Pushbuttons

ECM Alarms

The ECM has five standard alarm conditions indicated locally by LEDs and remotely by relays. Figure 3-5 describes the five alarm conditions. Make controller connections to the normally open and normally closed relay contacts provided.

Alarm	Description
High fuel	Alarm activates at 106% of normal fuel level.
Low fuel	Alarm activates at 62% of normal fuel level. The alarm provides time to respond to a potential problem before a low fuel shutdown occurs.
Critical low fuel (engine shutdown)	Alarm activates at 6% of normal fuel level to warn the operator to shut down the generator set before fuel runs out.
Fuel in rupture basin, if equipped	Alarm activates when the ECM detects fuel in the rupture basin.
ECM functional	Alarm activates to indicate a problem with the ECM operation. Note: The ECM functional alarm relay activates a user-installed alarm when the relay deenergizes.

Figure 3-5 ECM Alarms

3.5.3 Subbase Inner Fuel Tank Alarm

This kit provides for both audible and visual alarms from a location remote from the generator set if a leak is detected in the inner fuel tank of the double-wall subbase fuel tanks. See Figure 3-6. If the inner tank is leaking, a sensor installed in the outer tank sends an electrical signal to the alarm plate when the sensor becomes immersed in the fuel collecting in the outer tank. If a leak is detected, the alarm horn will sound and the fault lamp will light. The alarm horn is quieted by moving the alarm switch to the SILENCE position; the alarm lamp remains lit until the fault is corrected. See Figure 3-7 for troubleshooting information.

Resetting Procedure

Use the following procedure to reset the alarm after a fault alarm.

1. Move the alarm switch to the SILENCE position to stop the alarm horn. The lamp will remain lit.
2. Disconnect the generator set from the load with the line circuit breaker or the automatic transfer switch.
3. Repair or replace the inner fuel tank.
4. Move the generator set master switch to the OFF/RESET position and then to the RUN position for startup. The alarm horn sounds and the lamp goes out.

5. Reconnect the generator set to the load via the line circuit breaker or the automatic transfer switch.
6. Move the generator set master switch to the AUTO position for startup by remote transfer switch or remote start/stop switch. Move the alarm switch to the NORMAL position.

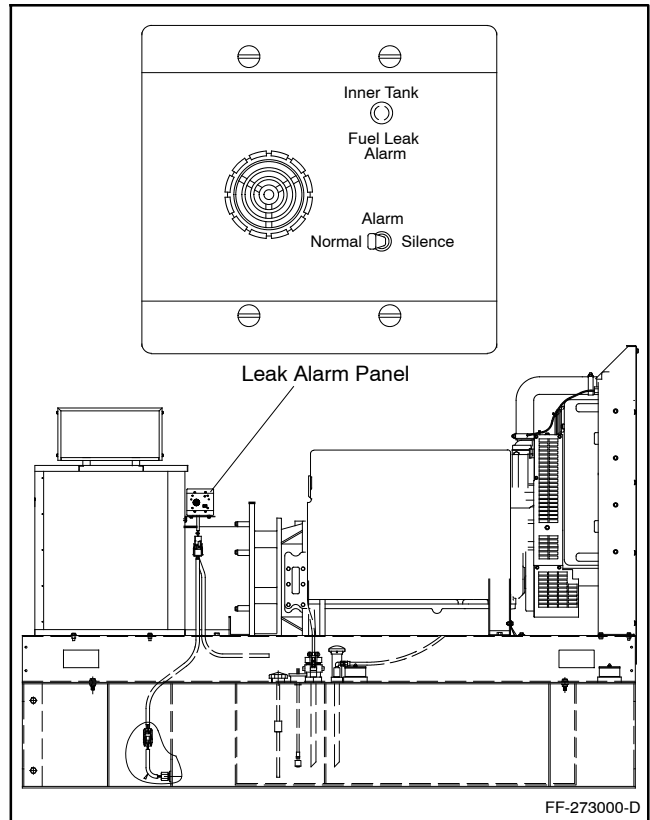

Figure 3-6 Inner Fuel Tank Leak Alarm (20–300 kW Model Shown)

Switch Position		Observation
Alarm	Float	
Normal	Open	The alarm horn and the lamp are not energized.
Normal	Closed	The alarm horn and lamp activate when a fuel leak occurs. If the alarm switch is moved to the silence position, the lamp stays on until the fuel leak fault is corrected.
Silence	Open	The alarm horn sounds to alert the user that the alarm horn switch is not in the normal position and that the alarm horn will not sound should a fuel leak occur.

Figure 3-7 Inner Fuel Tank Leak Alarm Troubleshooting

3.6 Gaseous Fuel Systems

Gaseous fuel systems apply to REZG_/RZG_/ERES_ (GM/PSI Powered) and REZX_/RZX_ (Doosan Powered) generator set models.

This section describes natural gas and liquified petroleum gas (LPG) fuel systems that are not covered in the engine operation manual or engine service manual.

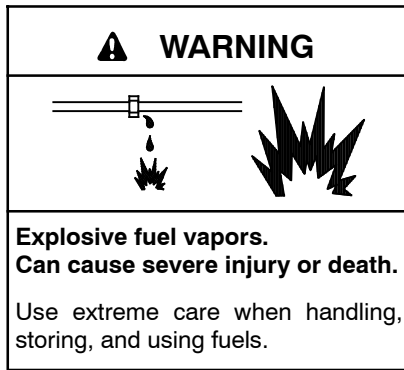

The fuel system. Explosive fuel vapors can cause severe injury or death. Vaporized fuels are highly explosive. Use extreme care when handling and storing fuels. Store fuels in a well-ventilated area away from spark-producing equipment and out of the reach of children. Never add fuel to the tank while the engine is running because spilled fuel may ignite on contact with hot parts or from sparks. Do not smoke or permit flames or sparks to occur near sources of spilled fuel or fuel vapors. Keep the fuel lines and connections tight and in good condition. Do not replace flexible fuel lines with rigid lines. Use flexible sections to avoid fuel line breakage caused by vibration. Do not operate the generator set in the presence of fuel leaks, fuel accumulation, or sparks. Repair fuel systems before resuming generator set operation.

Explosive fuel vapors can cause severe injury or death. Take additional precautions when using the following fuels:

Propane (LPG)—Adequate ventilation is mandatory. Because propane is heavier than air, install propane gas detectors low in a room. Inspect the detectors per the manufacturer's instructions.

Natural Gas—Adequate ventilation is mandatory. Because natural gas rises, install natural gas detectors high in a room. Inspect the detectors per the manufacturer's instructions.

3.6.1 Gaseous Fuel System Concept (Single Fuel)

The gaseous fuel system uses a fuel solenoid valve to control the fuel flow to the electronic-controlled pressure regulator (EPR). The generator set-mounted EPR reduces the fuel pressure as fuel passes to the fuel mixer. See Figure 3-8.

The fuel mixer controls the ratio of fuel to air under varying load and speed conditions. Because the fuel mixer receives fuel in a gaseous state, it does not have to vaporize the fuel.

3.6.2 LPG Liquid Withdrawal Fuel System Concept

With the LPG liquid withdrawal fuel system, pressurized liquid LPG fuel passes from the tank to a vaporizer. The vaporizer converts the liquid fuel to gas before sending it to the fuel EPR. The system also includes a fuel solenoid valve that shuts off the fuel flow when the engine stops. Contact an authorized service distributor/dealer for availability.

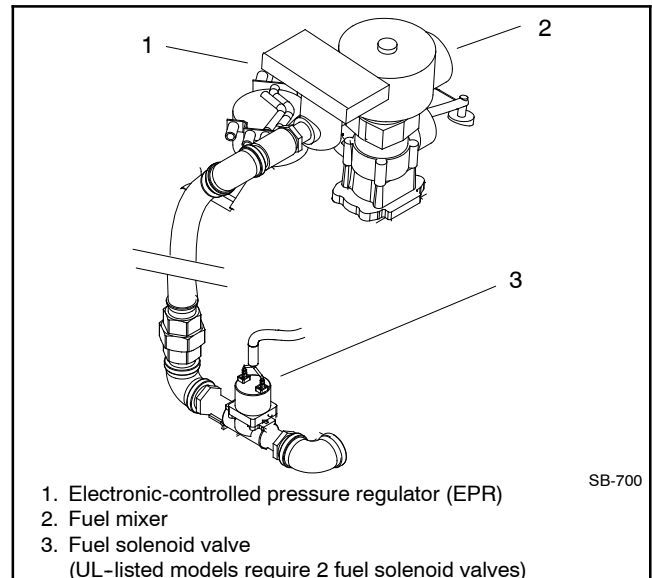

Figure 3-8 Fuel Regulator and Valve, Typical

3.6.3 Natural Gas and LPG Conversion

Most models operate on either natural gas or LPG fuel by performing the fuel conversion procedure. A hang tag on the fuel regulator may provide additional conversion setup information. Fuel conversion may decrease generator set output. Refer to the respective generator set spec sheet for ratings based on fuel selection. Changing fuel does not alter the emissions compliance of the generator set engine. Consult your local generator set distributor/dealer for additional information.

Note: If a gas-fueled model has the fuel type changed (LPG to natural gas or natural gas to LPG), order a new nameplate from an authorized distributor/dealer with the updated ratings and attach to the generator set.

To change the fuel type, change the electrical connections between the fuel system and the engine ECM. The engine ECM has fuel tables and spark advance curves programmed for both natural gas and LPG. The information shown in Figure 3-9 and Figure 3-10 generally apply to all models and all fuels. Be sure to review the respective wiring diagram for your specific model for possible special applications.

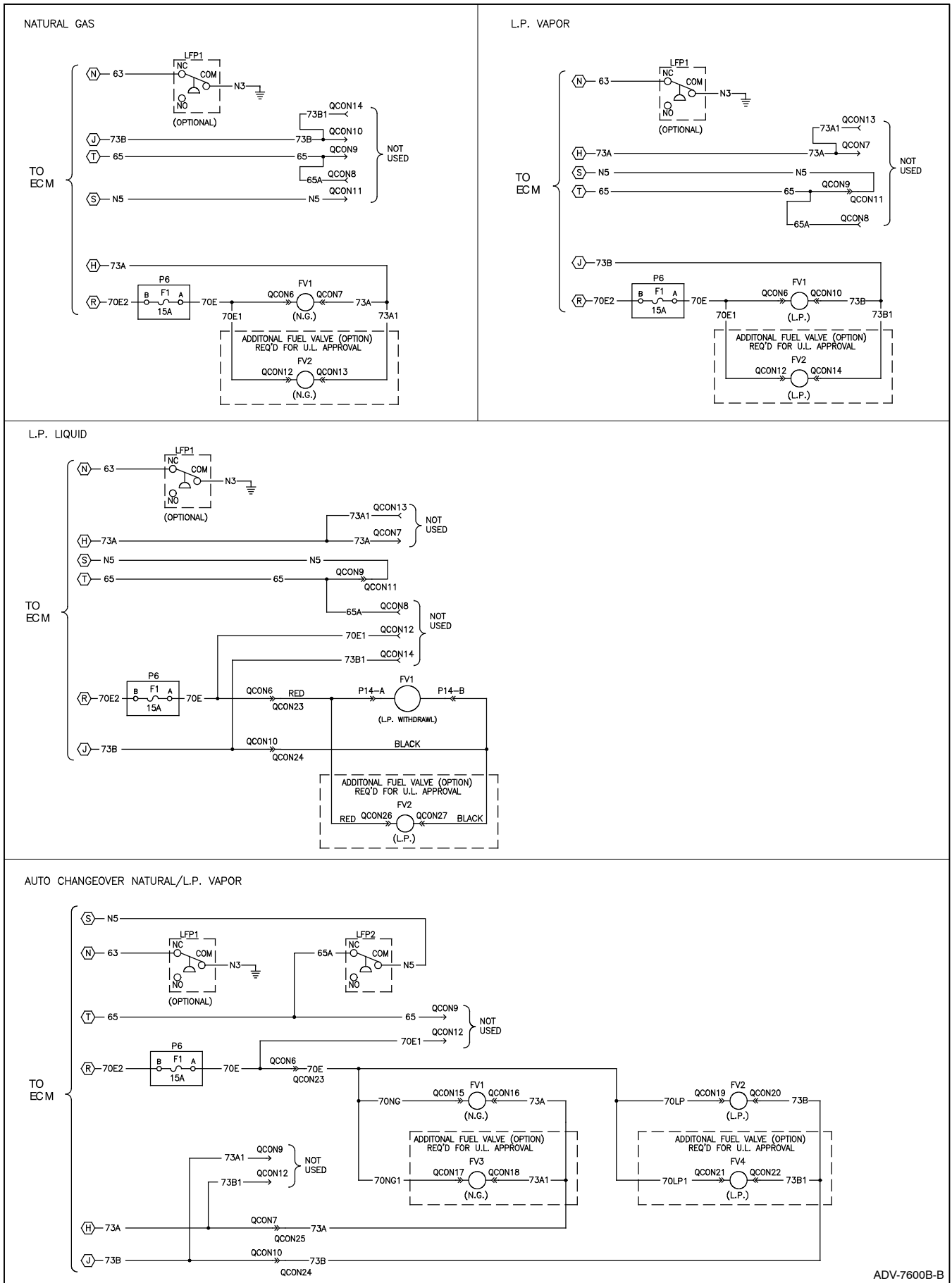

ADV-7600B-B

Figure 3-9 Gaseous Fuel Connections Wiring Diagram

Eng. ECM	Natural Gas	LPG Vapor	LPG Liquid	Auto Changeover
73A	QCON-7 (NG fuel solenoid valve)	not used		QCON-7 (NG fuel solenoid valve)
N5	not used	65	65	LFP2-COM
73B	not used	QCON-10 (LPG fuel solenoid valve)		
65	not used	N5	N5	not used
63	LFP1-NC low fuel pressure sensor (if used)			
70E2	P6-B (15 amp fuse)			

Figure 3-10 Gaseous Fuel Electrical Connections

Natural Gas Operation

- Disconnect lead 65 from lead N5.
- Disconnect lead 73B from the fuel solenoid valve.
- Connect lead 73A to the fuel solenoid valve.

LPG Vapor Operation

- Disconnect lead 73A from the fuel solenoid valve.
- Connect lead 73B to the fuel solenoid valve (LPG vapor).
- Connect lead 65 to lead N5 (ground).

LPG Liquid Withdrawal Operation

- Disconnect lead 73A from the fuel solenoid valve.
- Connect lead 73B to the fuel solenoid valve (LPG liquid withdrawal).
- Connect lead 65 to lead N5 (ground).

Auto Changeover Natural Gas/LPG Vapor Operation

- Disconnect lead 65 from N5.
- Connect lead N5 to LFP2 relay common terminal.
- Connect lead 73A to the fuel solenoid valve (natural gas).
- Connect lead 73B to the fuel solenoid valve (LPG vapor).

3.6.4 Fuel System Changeover Kits (Dual Fuel)

Automatic Changeover

A changeover fuel system kit provides automatic changeover from natural gas to LPG vapor. The primary and backup fuels each have a fuel solenoid valve. The primary fuel is natural gas; the backup fuel is LPG vapor. Before starting, both fuel solenoid valves are closed. When the generator set starts, the primary fuel solenoid valve opens. The primary fuel line has a pressure switch in series with a relay connected to the start/run circuit.

When the primary fuel pressure drops below 0.6 kPa (1.4 oz./in.²) or 6.4 cm (2.5 in.) water column, a relay opens the backup fuel solenoid valve and closes the primary fuel solenoid valve. When the primary fuel pressure rises above 0.6 kPa (1.4 oz./in.²) or 6.4 cm (2.5 in.) water column, the generator set uses the primary fuel. Contact an authorized service distributor/dealer for kit availability.

Emissions certified models use a single electronic-controlled pressure regulator (EPR) for both fuels. A tee fitting connects both fuels together upstream of the EPR. During operation when using the secondary fuel, it is normal for a small amount of secondary fuel to seep back through the primary fuel solenoid valve. To counter this situation, one of two methods is used depending upon the generator set model: (1) a second solenoid valve (identical to the primary fuel solenoid valve) is installed in a reverse configuration on the primary fuel side or (2) a small vent line is installed between the primary fuel inlet and the air intake through a fuel solenoid valve.

3.6.5 Crankcase Ventilation (CCV) Heater Kit GM78171-KP1

Applies to 125/150 kW, 8.1 L GM- and 8.8 L PSI-powered generator set models. Consult your local generator set distributor/dealer for additional information.

The crankcase ventilation (CCV) heater kit provides a controlled heating source to the crankcase ventilation system preventing freezing water buildup during cold weather. The thermostat turns on at 4°C (40°F) and turns off at 16°C (60°F) reducing energy consumption. See Figure 3-11.

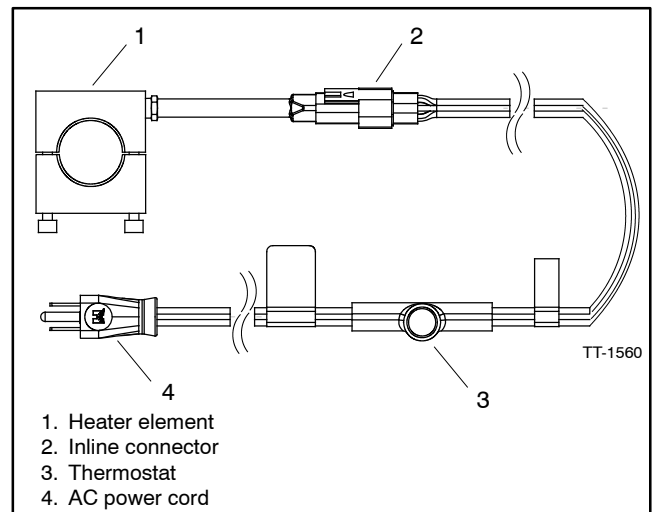

Figure 3-11 Crankcase Ventilation Heater Kit

3.7 Air Cleaner Restriction Indicator (if equipped)

The air cleaner restriction gauge mounted on the air cleaner(s) helps determine the air cleaner change interval.

The air cleaner restriction gauge monitors air flow and continuously displays restriction readings indicated as vacuum (see Figure 3-12). Increased restriction indicates a clogged air cleaner element.

As maximum allowable restriction is reached, the gauge window turns red indicating the air cleaner element needs replacement. To reset the gauge, push the gauge top down and release.

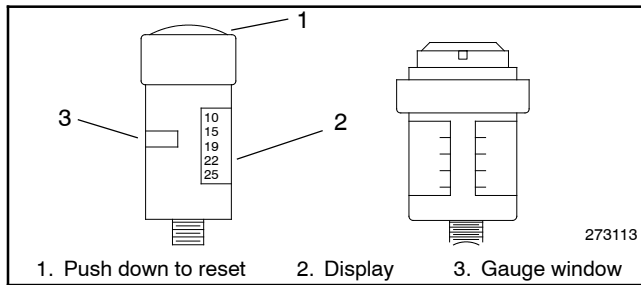



Figure 3-12 Restriction Indicators (styles vary)

3.8 Cooling System

The cooling system maintenance information applies to radiator-cooled models and city-water-cooled (heat exchanger) models. The cooling systems function similarly even though they use different components. Radiator-cooled models have a radiator with a pressure cap and coolant recovery tank. City-water-cooled models have a heat exchanger and an expansion/surge tank with a pressure cap.

Note: The 20–40 kW Deutz engine-powered generator sets are oil-cooled and, therefore, do not have a water cooling system.

 WARNING

Hot coolant and steam. Can cause severe injury or death.
Before removing the pressure cap, stop the generator set and allow it to cool. Then loosen the pressure cap to relieve pressure.

Allow the engine to cool. Release pressure from the cooling system before removing the pressure cap. To release pressure, cover the pressure cap with a thick cloth and then slowly turn the cap counterclockwise to the first stop. Remove the cap after pressure has been completely released and the engine has cooled. Check the coolant level at the tank if the generator set has a coolant recovery tank.

Note: Engine damage. Bleed the air from the cooling system to prevent overheating and subsequent engine damage.

Note: Block heater damage. The block heater will fail if the energized heater element is not immersed in coolant. Fill the cooling system before turning on the block heater. Run the engine until it is warm, and refill the radiator to purge the air from the system before energizing the block heater.

3.8.1 Coolant Level Check

Check the coolant level in the coolant recovery tank. Maintain the coolant level between the high and low marks.

Note: Periodically check the coolant level by removing the pressure cap. Do not rely solely on the level in the coolant recovery tank. Add fresh coolant until the level is just below the overflow tube opening of the filler neck.

3.8.2 Cooling System Component Inspection

To prevent generator set shutdown or damage caused by overheating:

- Keep the cooling air inlets clean and unobstructed.
- Inspect the radiator's exterior for obstructions. Remove dirt and foreign material using a soft brush or cloth to avoid damaging the radiator fins.
- Check the hoses and connections for leaks. Replace any cracked, frayed, or spongy hoses.
- Check the condition and tension of the radiator fan and water pump belt(s). Follow the belt tension procedure in this manual and/or the engine operation manual.
- Check the pressure cap seal and replace a cracked or deteriorated cap. Remove dirt and other debris from the pressure cap and filler neck. The pressure cap raises the boiling point of the coolant, enabling higher operating temperatures. Replace a leaking pressure cap with one rated for the same pressure. The pressure cap rating usually appears on the pressure cap.

3.8.3 Procedure to Drain Cooling System

For optimum protection, drain, flush, and refill the cooling system at the intervals listed in the service schedule.

Note: Dispose of all waste materials (oil, fuel, coolant, filters, and gaskets) in an environmentally safe manner.

1. Deenergize the block heater, if equipped.
2. Remove the pressure cap to allow the entire system to drain and prevent air pockets from restricting coolant flow through the engine block.
3. Open the radiator and/or engine block coolant drain valve(s) and allow the system to drain.
4. If the inside of the radiator has mineral deposits or the used coolant contains dirt or grease, refer to Section 3.8.4, Procedure to Flush and Clean the Cooling System. If the cooling system does not have mineral deposits, go to Section 3.8.5, Procedure to Refill the Cooling System.

3.8.4 Procedure to Flush and Clean Cooling System

Use the instructions in the engine operation manual when available to flush and clean the cooling system. Otherwise, use the following procedure and the cooling system cleaner manufacturer's instructions.

1. Flush the cooling system with clean water.
2. If the inside of the radiator still has mineral deposits, use a radiator cleaner to remove the remaining deposits following the manufacturer's instructions.
3. Drain, clean, and flush the coolant recovery tank.

3.8.5 Procedure to Refill Cooling System

See the generator set spec sheet for coolant capacity.

Note: Do not add coolant to a hot engine. Adding coolant to a hot engine can cause the cylinder block or cylinder head to crack. Wait until the engine has cooled.

1. Remove the pressure cap.

2. Close the radiator and/or engine block coolant drain valve(s) and tighten the cooling system hose clamps.
3. Open the air-bleed petcocks, if equipped. Close the air-bleed petcocks when coolant begins to flow from them.
4. Add coolant additives or water pump lubricants according to the engine manufacturer's recommendations in the engine operation manual.
5. Fill the cooling system with a coolant/antifreeze mixture based on the engine manufacturer's recommendation.
6. Replace the pressure cap.
7. Fill the coolant recovery tank to the low mark.
8. Operate generator set until the thermostat opens when the upper cooling system hose warms.
9. Stop the engine and allow it to cool.
10. Check and repair any coolant leaks.
11. Remove the pressure cap.
12. Add coolant to bring the coolant level to just below the overflow tube opening of the filler neck.
13. Replace the pressure cap.
14. Maintain the coolant level in the coolant recovery tank between the high and low marks.
15. Reenergize the block heater, if equipped.

Note: Air pockets often form in the engine water jacket when the coolant system is refilled. Check the coolant level in the coolant recovery tank after each generator set operation and add coolant as necessary until the coolant level stabilizes. Then check the coolant at the interval specified in the service schedule.

3.9 Radiator Fan Bolt Retorque

Adapted from Service Bulletin SB-683.

Check the radiator fan bolts after approximately 8 hours of operation and then recheck after each 100 hours of operation. This scheduled service is required on 1500-

2250REOZDC, 2500-2800REOZDB, and 3000/3250REOZD unit-mounted radiator models using a 2743 mm (108 in.) diameter fan.

Perform the scheduled service steps in the order shown.

Required Tools

- Socket wrench sets American Standard and Metric sizes
- Torque wrench, up to 203 Nm (150 ft. lb.)

Procedure

1. Place the generator set master switch in the OFF/RESET position.
2. Disconnect the power to the battery charger, if equipped.
3. Disconnect the generator set engine starting battery(ies), negative (-) lead first.
4. Remove the fan guards, screens, and covers as necessary to access the radiator fan hardware.
5. Inspect the blades for cracks or other damage. Verify that all hardware is present. Replace as needed.
6. Retorque the (32 qty.) blade retention bolts/nuts to 136 Nm (100 ft. lb.). See Figure 3-13.
7. Retorque the (12 qty.) hub boss cap screws to 102 Nm (75 ft. lb.). There are six screws on each side of the fan.
8. Retorque the (3 qty.) bushing cap screws to 43 Nm (32 ft. lb.).
9. Replace the fan guards, screens, and covers that were removed to access the radiator fan hardware.
10. Check that the generator set master switch is in the OFF position.
11. Reconnect the generator set engine starting battery, negative (-) lead last.
12. Reconnect power to the battery charger, if equipped.
13. Place the generator set master switch to the RUN position to start the generator set. Refer to the respective generator set operation manual as needed.

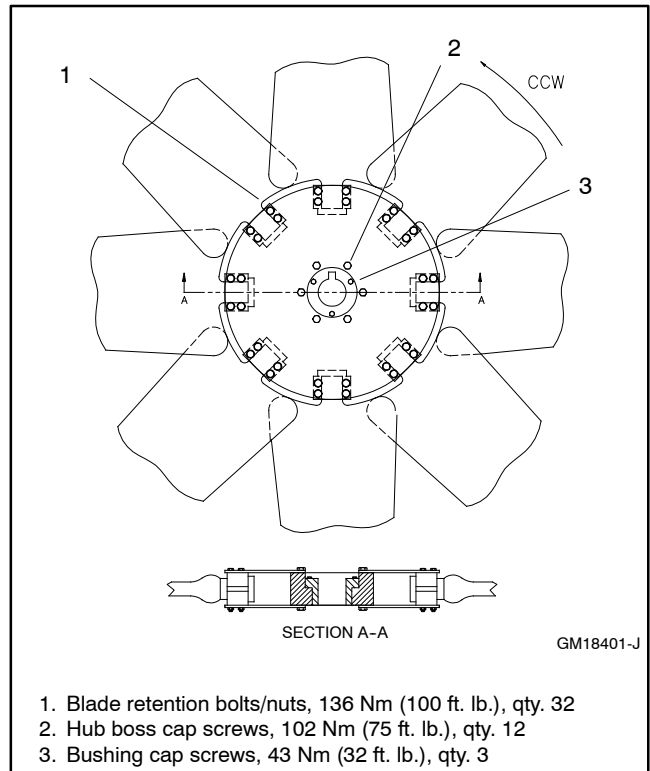

Figure 3-13 Fan Hardware Location and Torque

14. Listen and observe the fan operation.
15. **Immediately shut down the generator set if abnormal noise or fan assembly vibration is observed.** Correct the problem and go back to step 13.
16. After several minutes of generator set operation without abnormal noise or vibration, shut down the generator set by placing the generator set master switch to the OFF/RESET position.

3.10 Radiator Expansion Joint Loosening—Initial Setup Only

Loosen the radiator expansion joint nuts on 1200-2000 kW generator sets that have radiators manufactured by Young Radiator Company. Expansion joints located on each side of the radiator permit differential thermal expansion of the radiator tank. The factory tightens the 12 expansion joint nuts before generator set shipment. Loosen the expansion joint nuts one full turn before running the generator set. See Figure 3-14.

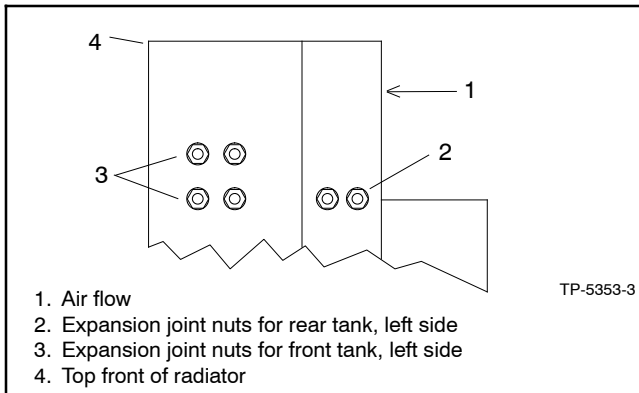

Figure 3-14 Expansion Joint Nuts, Top Left Side of Radiator, Typical

3.11 Radiator Fan Bearing Lubrication

The following procedure applies only to 1200 kW and larger generator sets. Lubricate the radiator fan shaft and idler shaft bearings at every engine oil change to avoid bearing damage. Lubricate the bearings every 200 hours of operation when the generator set runs in ambient temperatures below 29°C (85°F) or when the generator set runs in a dusty and/or humid environment.

Lubrication and Drive Belt Adjustment Procedure

Lubricate the fan shaft and idler shaft bearings with a lithium-complex base, multi-purpose grease with antirust, antifoam, and extreme-pressure additives having a minimum dropping point of 204°C (400°F). Use Mobil Mobilith AW2 NLGI Grade 2 or equivalent.

1. Place the generator set master switch in the OFF/RESET position.
2. Disconnect the generator set engine starting battery(ies), negative (-) lead first, and disconnect power to the battery charger.
3. Remove the belt guards to expose the fan shaft and idler shaft bearings.
4. Inject grease into the two bearings on the fan shaft block and the two bearings on the idler shaft block using a grease gun until a 3–6 mm (0.13–0.25 in.) grease column shows at the bearing pressure relief port. See Figure 3-15.

Note: The fan shaft and idler shaft bearings have pressure relief ports to prevent bearing damage caused by overlubrication.

5. Remove excess grease from the bearing pressure relief ports.

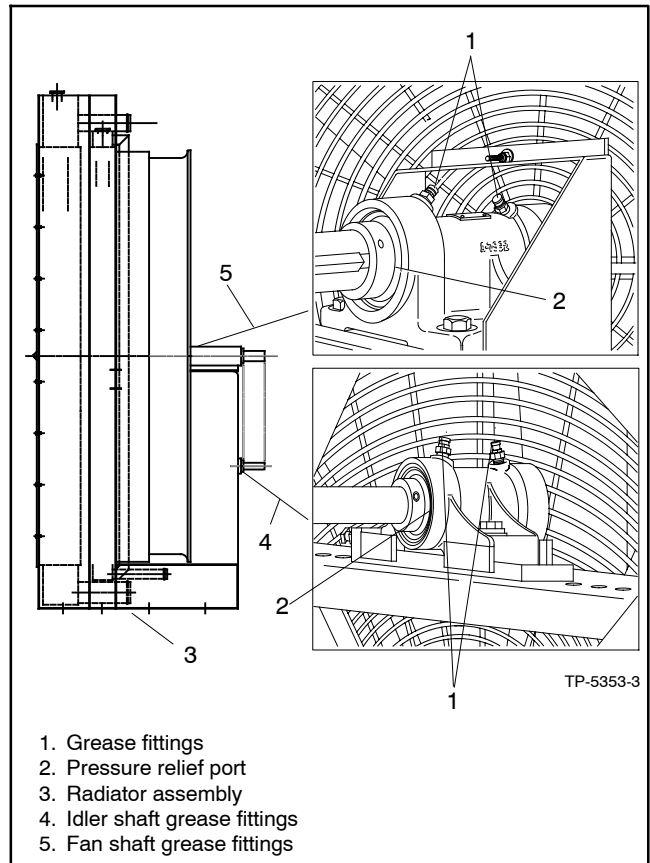

Figure 3-15 Radiator Fan Bearings and Pressure Relief Ports, Typical

6. Inspect the fan drive belt and replace if it is damaged or worn. Check the fan belt tension using a poly V-belt tension gauge and adjust the tension, if necessary. See Figure 3-16.
7. Reinstall the belt guards using the original hardware.

Generator Set Model	New Belt, N (lbf.)	Used Belt*, N (lbf.)
1200-2250 kW	2450-2890 (550-650)	1650-1910 (370-430)

* A belt is considered used after 50 hours of service.

Figure 3-16 Poly V-Belt Tension Specifications

8. Reconnect the generator set engine starting battery(ies), negative (-) lead last.
9. Test run the generator set for a few minutes and listen for belt noise (squeal) indicating a slipping belt. Stop the generator set.

If the belt slips after the belt tension procedure, clean the pulley surfaces and repeat the belt tension procedure. If slippage continues, replace the fan belt.

3.12 Battery

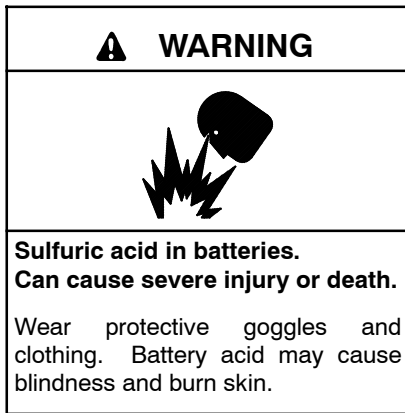

Battery electrolyte is a diluted sulfuric acid. Battery acid can cause severe injury or death. Battery acid can cause blindness and burn skin. Always wear splashproof safety goggles, rubber gloves, and boots when servicing the battery. Do not open a sealed battery or mutilate the battery case. If battery acid splashes in the eyes or on the skin, immediately flush the affected area for 15 minutes with large quantities of clean water. Seek immediate medical aid in the case of eye contact. Never add acid to a battery after placing the battery in service, as this may result in hazardous spattering of battery acid.

Battery acid cleanup. Battery acid can cause severe injury or death. Battery acid is electrically conductive and corrosive. Add 500 g (1 lb.) of bicarbonate of soda (baking soda) to a container with 4 L (1 gal.) of water and mix the neutralizing solution. Pour the neutralizing solution on the spilled battery acid and continue to add the neutralizing solution to the spilled battery acid until all evidence of a chemical reaction (foaming) has ceased. Flush the resulting liquid with water and dry the area.

Battery gases. Explosion can cause severe injury or death. Battery gases can cause an explosion. Do not smoke or permit flames or sparks to occur near a battery at any time, particularly when it is charging. Do not dispose of a battery in a fire. To prevent burns and sparks that could cause an explosion, avoid touching the battery terminals with tools or other metal objects. Remove all jewelry before servicing the equipment. Discharge static electricity from your body before touching batteries by first touching a grounded metal surface away from the battery. To avoid sparks, do not disturb the battery charger connections while the battery is charging. Always turn the battery charger off before disconnecting the battery connections. Ventilate the compartments containing batteries to prevent accumulation of explosive gases.

Battery short circuits. Explosion can cause severe injury or death. Short circuits can cause bodily injury and/or equipment damage. Disconnect the battery before generator set installation or maintenance. Remove all jewelry before servicing the equipment. Use tools with insulated handles. Remove the negative (-) lead first when disconnecting the

battery. Reconnect the negative (-) lead last when reconnecting the battery. Never connect the negative (-) battery cable to the positive (+) connection terminal of the starter solenoid. Do not test the battery condition by shorting the terminals together.

Refer to this section for general battery information and maintenance. All generator set models use a negative ground with a 12-volt or 24-volt engine electrical system. Consult the generator set nameplate for the engine electrical system voltage. Consult the generator set spec sheet for battery capacity recommendations for replacement purposes. The wiring diagrams provide battery connection information. See Figure 3-17, Figure 3-18, and Figure 3-19 for typical battery connections, including multiple battery configurations.

3.12.1 Clean Battery

Clean the battery and cables and tighten the battery terminals according to the service schedule recommendations. Clean the battery by wiping it with a damp cloth. Keep the electrical connections dry and tight.

If corrosion exists, disconnect the cables from the battery and remove the corrosion with a wire brush. Clean the battery and cables with a solution of baking soda and water. Do not allow the cleaning solution to enter battery cells. Flush the battery and cables with clean water and wipe the battery with a dry cloth.

After reconnecting the battery cables, coat the terminals with petroleum jelly, silicon grease, or other nonconductive grease.

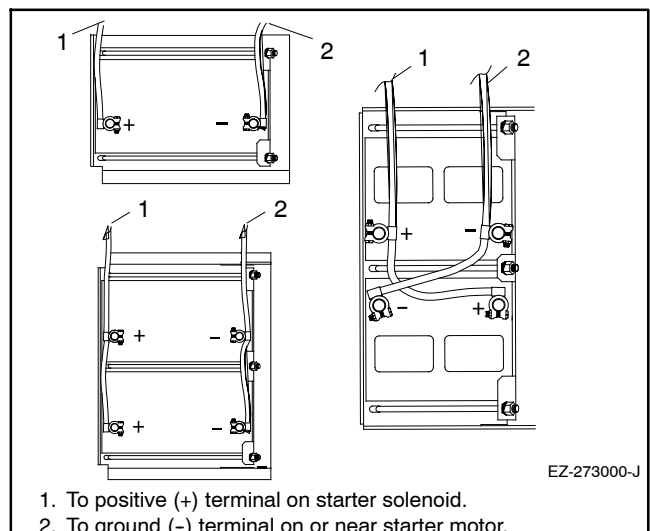

Figure 3-17 12-Volt Engine Electrical System Single Starter Motor Typical Battery Connection

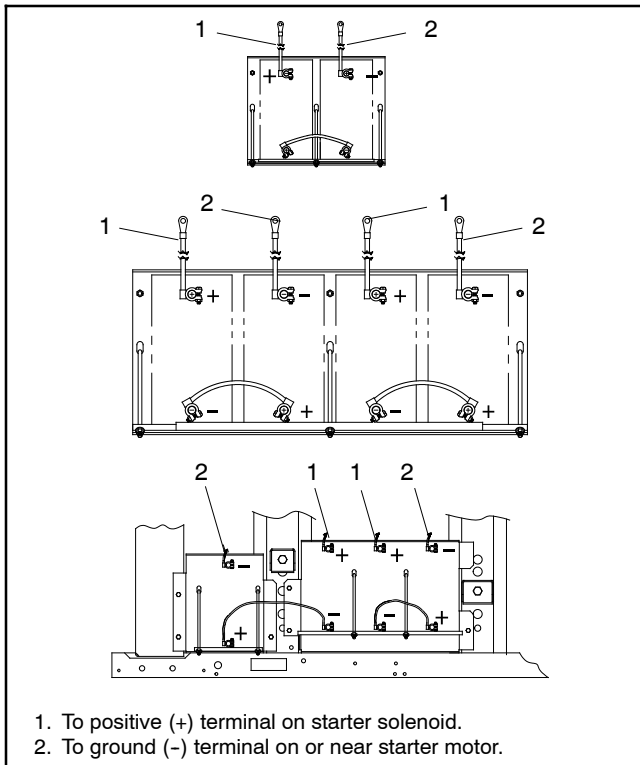

Figure 3-18 24-Volt Engine Electrical System Single Starter Motor Typical Battery Connection

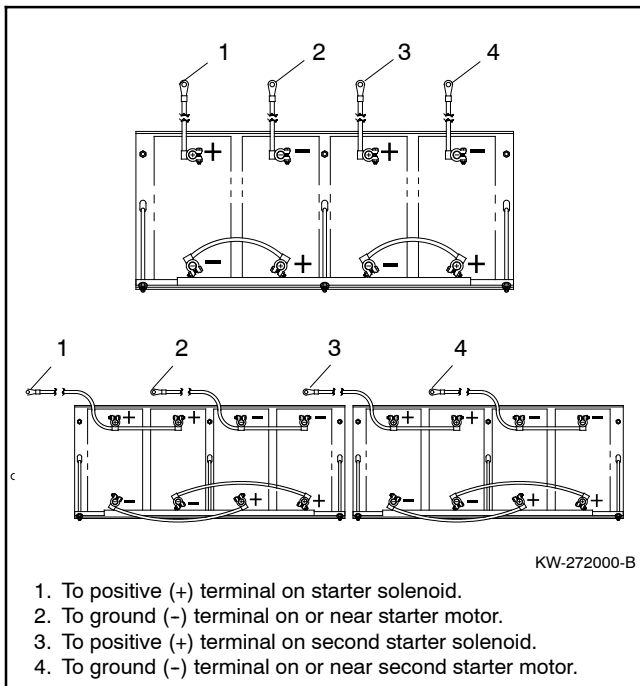

Figure 3-19 24-Volt Engine Electrical System Dual Starter Motors Typical Battery Connections

3.12.2 Electrolyte Level Inspection

Check the electrolyte level and specific gravity of batteries that have filler caps. Maintenance-free batteries do not require electrolyte level checking or specific gravity testing.

Check the electrolyte level at the specified interval. Remove the filler caps and verify that the electrolyte level reaches the bottom of each filler hole. See Figure 3-20. Refill as necessary with distilled water or clean tap water. Do not add fresh electrolyte. Tighten the filler caps. After adding water during freezing temperatures, run the generator set 20–30 minutes to mix the electrolyte and the water to prevent battery damage from freezing.

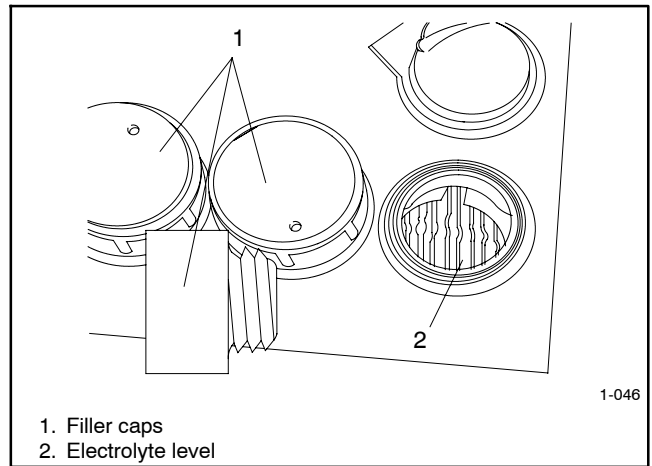

Figure 3-20 Battery Electrolyte Level Inspection

3.12.3 Specific Gravity Check

Use a battery hydrometer to check the specific gravity of the electrolyte in each battery cell of batteries with filler caps. Holding the hydrometer vertically, read the number on the glass bulb at the top of the electrolyte level or the number adjacent to the pointer. If the hydrometer used does not have a correction table, consult Figure 3-21. Determine the specific gravity and electrolyte temperature of the battery cells. Locate the temperature in Figure 3-21 and correct the specific gravity by the amount shown. The battery is fully charged if the specific gravity is 1.260 at an electrolyte temperature of 26.7°C (80°F). Maintain the specific gravities between cells within ±0.01 of each other. Charge the battery if the specific gravity is below 1.215 at an electrolyte temperature of 26.7°C (80°F).

Note: Some battery testers have four or five beads in a test tube. Draw electrolyte into the tube as with the battery hydrometer described in this section or use the manufacturer's instructions. Use Figure 3-22 to interpret typical test results.

3.12.4 Charge Battery

Use a battery charger to maintain a fully charged battery when the generator set is used in a standby application. The engine battery-charging alternator charges the battery while the generator set is running.

Note: If the generator set is in a temporary prime power application in which the generator set has periods of inactivity, the controller circuitry may drain the battery. If there is no power source for a battery charger, place the controller in the prime power mode, if equipped, or disconnect the battery from the generator set.

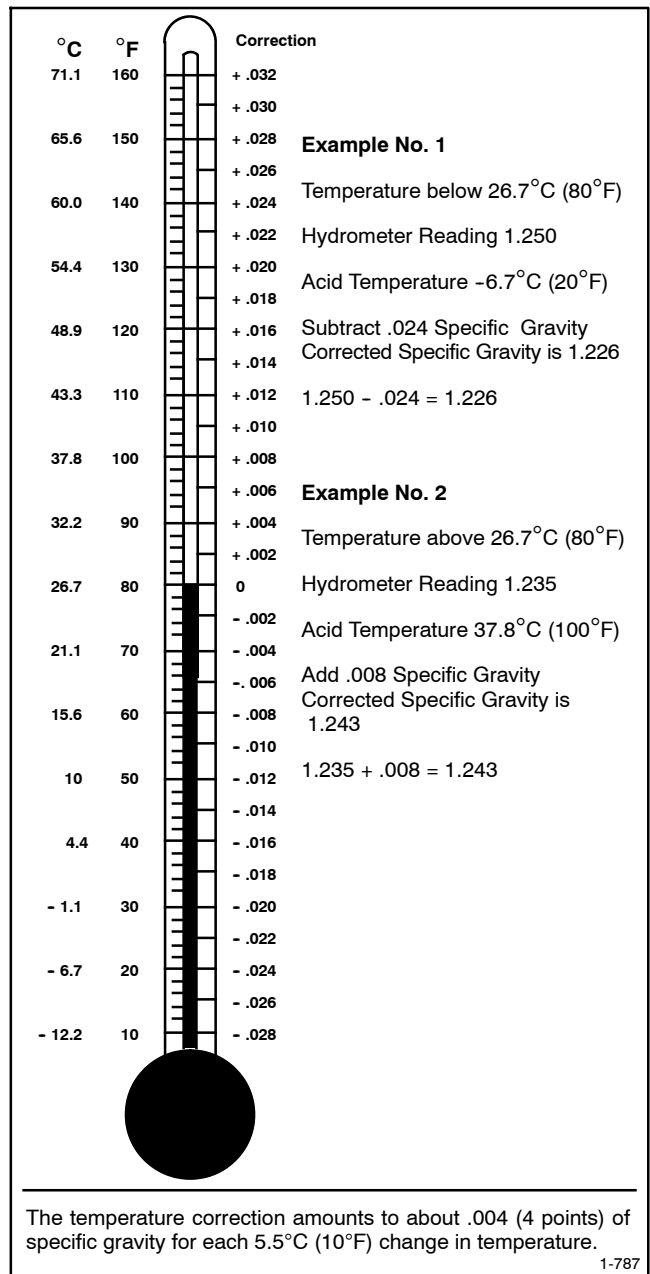

Figure 3-21 Specific Gravity Temperature Correction

Number of Floating Beads	Battery Condition
5	Overcharged
4	Fully charged
3	A good charge
1 or 2	A low charge
0	A dead battery

Figure 3-22 Bead-Type Test Interpretation

3.13 Detroit Diesel Engine Control Systems

Some generator sets equipped with Detroit Diesel engines use a DDEC/MDEC/ADEC system. Access the DDEC control box inside the generator set junction box to retrieve codes when performing routine maintenance or troubleshooting the engine.

Note: DDC/MTU engines with MDEC/ADEC use the 550 controller to display all engine fault code numbers. The engine operation manual provides the fault code description.

Use the following data for informational purposes only. Consult the engine literature for complete information regarding DDEC/MDEC/ADEC operation and troubleshooting. See List of Related Materials in the Introduction section. Contact an authorized service distributor/dealer for service or diagnostic equipment.

3.13.1 Features

The engine control system optimizes control of critical engine functions and protects against serious engine damage resulting from conditions such as the following:

- Low coolant level
- Low coolant pressure
- High coolant temperature
- Low oil pressure
- High oil temperature

The major components of the DDEC/MDEC/ADEC system include the electronic control module (ECM) and engine sensors. The DDEC control box is located in the generator set junction box.

3.13.2 DDEC Engine Diagnostics

The DDEC engine protection system monitors engine sensors and electronic components and recognizes system malfunctions. Critical faults light the check engine (CEL) and stop engine (SEL) lamps on the control box. ECM memory software logs malfunction codes. Consult the engine operation manual or engine service manual to identify the stored failure code. See Figure 3-23 for the DDEC control box features.

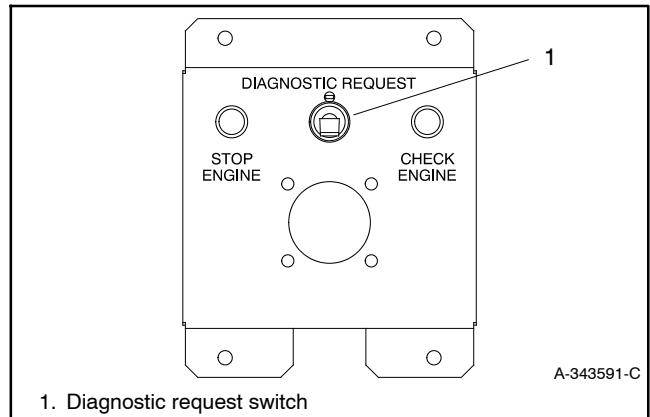

Figure 3-23 DDEC Control Box

Access the stored codes in one of three ways:

- Place the switch in the DIAGNOSTIC REQUEST position. The CEL or SEL flashes to identify the failure.
- Use a hand-held diagnostic data reader (DDR). Place the switch in the DIAGNOSTIC DATA READER position. Plug the DDR into the control box. The DDR displays the stored failure codes.
- Use a personal computer software package available from the manufacturer with a translator to access stored codes. Follow the instructions provided with the software.

Code Types

Active code. A code flashing on the SEL lamp indicates a fault currently exists.

Inactive code. A code flashing on the CEL lamp indicates a previous fault occurrence. The ECM memory stores inactive codes with time/date identification and the following information:

- First occurrence of each diagnostic code in engine operating hours.
- Last occurrence of each diagnostic code in engine operating hours.
- Total time in seconds that the diagnostic code was active.

3.14 Engine Control Systems

Some generator sets use an engine control system. Access the control box inside the generator set junction box to retrieve codes when performing routine maintenance or troubleshooting engine.

Use the following data for general informational purposes only. See the Engine Service Manual for complete information regarding operation and troubleshooting. Contact an authorized service distributor/dealer for service or diagnostic equipment.

Engine Control Features

Engine control is an advanced-technology, electronic engine control system. The system optimizes control of critical engine functions and provides protection against serious engine damage.

The major components include the engine control module, engine sensors, and control box located in the generator set junction box.

See Figure 3-24 for the Deutz control box features.

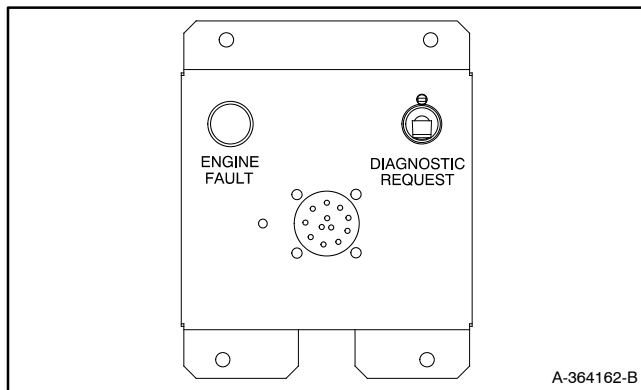

Figure 3-24 Deutz Engine Control Box

See Figure 3-25 for the John Deere engine control box features.

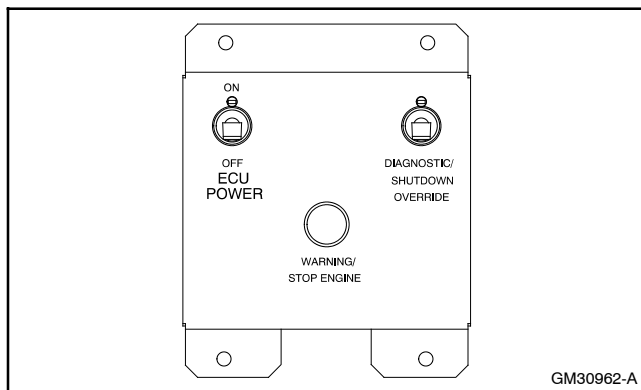

Figure 3-25 John Deere Engine Control Box

See Figure 3-26 for the Kohler-branded D300, D350, D400, D450, and D500 engine control box features.

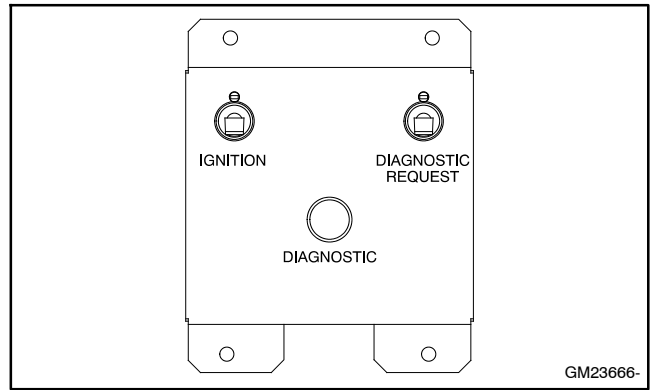

Figure 3-26 Kohler-Branded Engine Control Box

3.15 Storage Procedure

Perform the following storage procedure before taking a generator set out of service for three months or longer. Follow the engine manufacturer's recommendations, if available, for fuel system and internal engine component storage.

⚠ WARNING
<p>Accidental starting. Can cause severe injury or death.</p> <p>Disconnect the battery cables before working on the generator set. Remove the negative (-) lead first when disconnecting the battery. Reconnect the negative (-) lead last when reconnecting the battery.</p>

Disabling the generator set. Accidental starting can cause severe injury or death. Before working on the generator set or equipment connected to the set, disable the generator set as follows: (1) Move the generator set master switch to the OFF position. (2) Disconnect the power to the battery charger. (3) Remove the battery cables, negative (-) lead first. Reconnect the negative (-) lead last when reconnecting the battery. Follow these precautions to prevent starting of the generator set by an automatic transfer switch, remote start/stop switch, or engine start command from a remote computer.

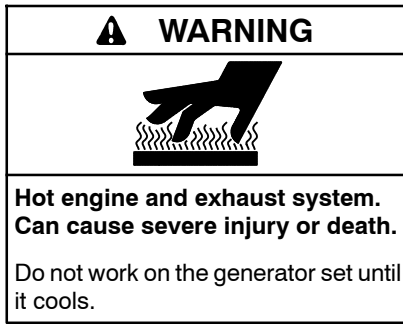

Servicing the exhaust system. Hot parts can cause severe injury or death. Do not touch hot engine parts. The engine and exhaust system components become extremely hot during operation.

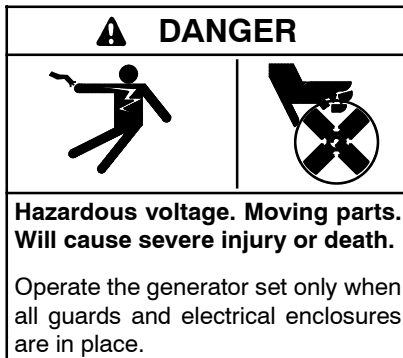

Servicing the generator set when it is operating. Exposed moving parts will cause severe injury or death. Keep hands, feet, hair, clothing, and test leads away from the belts and pulleys when the generator set is running. Replace guards, screens, and covers before operating the generator set.

3.15.1 Lubricating System

Prepare the engine lubricating system for storage as follows:

1. Run the generator set for a minimum of 30 minutes to bring it to normal operating temperature.
2. Stop the generator set.
3. With the engine still warm, drain the oil from the crankcase.
4. Remove and replace the oil filter.
5. Refill the crankcase with oil suited to the climate.
6. Run the generator set for two minutes to distribute the clean oil.
7. Stop the generator set.
8. Check the oil level and adjust, if needed.

3.15.2 Cooling System

Prepare the cooling system for storage as follows:

1. Check the coolant freeze protection using a coolant tester.
2. Add or replace coolant as necessary to ensure adequate freezing protection. Use the guidelines included in the engine operation manual.
3. Run the generator set for 30 minutes to redistribute added coolant.

3.15.3 Fuel System

Prepare the fuel system for storage as follows:

Diesel-Fueled Engines

1. Fill the fuel tank with the specified diesel fuel.
2. Condition the fuel system with compatible additives to control microbial growth.
3. Change the fuel filter/separator and bleed the fuel system. See the engine owner's manual.

Gas-Fueled Engines

1. Start the generator set.
2. With the generator set running, shut off the gas supply.
3. Run the generator set until the engine stops.
4. Place the generator set master switch in the OFF/RESET position.

3.15.4 Internal Engine Components (Gaseous-Fueled Engines)

If you have access to a fogging agent or SAE 10 oil prepare the pistons and cylinders for storage as follows:

1. While the engine is running, spray a fogging agent or SAE 10 engine oil into the air intake for about two minutes until the engine stops.
2. Place the generator set master switch in the OFF/RESET position.

If a fogging agent is not available perform the following:

1. Remove the spark plugs.

2. Pour 15 cc (0.5 oz.) of engine oil into each spark plug hole.

Ignition System Damage. Refer to the engine operation manual for ignition system precautions before cranking the engine while the spark plug wires are disconnected.

3. Toggle the generator set master switch to crank the engine two or three revolutions to lubricate the cylinders.
4. Reinstall the spark plugs and torque them to specifications.

3.15.5 Exterior

1. Clean the exterior surface of the generator set.
2. Seal all engine openings except for the air intake with nonabsorbent adhesive tape.
3. To prevent impurities from entering the air intake and to allow moisture to escape from the engine, secure a cloth over the air intake.
4. Mask electrical connections.
5. Spread a light film of oil over unpainted metallic surfaces to inhibit rust and corrosion.

3.15.6 Battery

Perform battery storage after all other storage procedures.

1. Place the generator set master switch in the OFF/RESET position.
2. Disconnect the battery(ies), negative (-) lead first.
3. Clean the battery. Refer to Section 3.12.1 for the battery cleaning procedure.
4. Place the battery in a cool, dry location.
5. Connect the battery to a battery charger or charge it monthly with a trickle battery charger. Refer to the battery charger manufacturer's recommendations.

Maintain a full charge to extend battery life.

Section 4 General Troubleshooting

This section contains generator set troubleshooting, diagnostic, and repair information.

Note: The controller clock must be set each time the engine battery(ies) are disconnected. The controller clock determines exercise run time and event records. See Menu 6—Time and Date, for setup.

Use the following charts to diagnose and correct common problems. First check for simple causes such as a dead engine starting battery or an open circuit breaker. The charts include a list of common problems, possible causes of the problem, recommended corrective actions, and references to detailed information or repair procedures.

Maintain a record of repairs and adjustments performed on the equipment. If the procedures in this manual do not explain how to correct the problem, contact an authorized distributor/dealer. Use the record to help describe the problem and repairs or adjustments made to the equipment.

Battle Switch/Fault Shutdown Override Switch. The *battle* switch function forces the system to ignore normal fault shutdowns such as low oil pressure and high engine temperature. The battle switch does not override the emergency stop, overspeed, and overfrequency shutdowns. When the battle switch function is enabled, the generator set continues to run regardless of shutdown signals where potential engine/alternator damage can occur.

When this input is enabled, the yellow warning lamp illuminates and stored warning/shutdown events that are ignored continue to log in Menu 5—Event History.

See Section 2.9.9, Menu 9—Input Setup, for information on how to enable the battle switch feature.

Cooldown Temperature Override Function. This function provides the ability to bypass the generator set temperature based cooldown and force the unit to wait for the engine cooldown time delay.

If the generator set is shutting down before the full cooldown time expires, inspect the Cooldown Temperature Override setting. Set the override to YES to force the unit to run in cooldown for the entire cooldown delay.

If the generator set is not shutting down when coolant temperature falls below the cooled down threshold, inspect the Cooldown Temperature Override setting. Set the override to NO enabling smart temperature based cooldown.

See Section 2.9.8, Menu 8—Time Delays, for information on how to enable the cooldown temperature override feature.

Appendix G, DEC 550 Controller Fault Displays, provides additional information regarding warning and shutdown faults and their related sensors or controller logic protection for each engine family.

4.1 General Troubleshooting Chart

Trouble Symptoms										Probable Causes	Recommended Actions	Section or Publication Reference*	
Does not crank	Cranks but does not start	Starts hard	No or low output voltage	Stops suddenly	Lacks power	Overheats	Low oil pressure	High fuel consumption	Excessive or abnormal noise				Displays error message/locks up
Alternator													
			x								AC output circuit breaker open	Reset the breaker and check for AC voltage at the generator set side of the circuit breaker.	—
x											Transfer switch test switch in the OFF position	Move the transfer switch test switch to the AUTO position.	ATS O/M
			x								Transfer switch fails to transfer load	Move the ATS test switch to the AUTO position. Troubleshoot the transfer circuit and time delays.	ATS O/M, S/M
			x								Wiring, terminals, or pin in the exciter field open	Check for continuity.	Gen. S/M, W/D
			x								Main field (rotor) inoperative (open or grounded)	Test and/or replace the rotor.†	Gen. S/M
			x								Stator inoperative (open or grounded)	Test and/or replace the stator.†	Gen. S/M
									x		Vibration excessive	Tighten loose components.†	—
			x								Voltage regulator digital settings incorrect (digital controller only)	Adjust the voltage regulator.	Sec. 2.9.11, Menu 11
			x								Light flicker caused by armature leads incorrectly connected to FRX activator board (FRX alternator only)	Check that AC1, AC2, and AC3 from exciter armature are correctly connected to the FRX activator board terminals.	Gen. S/M, W/D
Electrical System (DC Circuits)													
x	x										Battery connections loose, corroded, or incorrect	Verify that the battery connections are correct, clean, and tight.	Section 3
x	x										Battery weak or dead	Recharge or replace the battery. The spec sheet provides recommended battery CCA rating.	Section 3, S/S
x	x										Starter/starter solenoid inoperative	Replace the starter or starter solenoid.	Eng. S/M
x			x								Engine harness connector(s) not locked tight	Disconnect the engine harness connector(s) then reconnect it to the controller.	W/D
			x								High water temperature switch inoperative	Replace the inoperative switch.	Gen. S/M or W/D
											Fault shutdown	Reset the fault switches and troubleshoot the controller.	Section 2
											High exhaust temperature switch inoperative	Replace the inoperative switch.	Gen. S/M or W/D
<p>* Sec./Section—numbered section of this manual; ATS—Automatic Transfer Switch; Eng.—Engine; Gen.—Generator Set; I/M—Installation Manual; O/M—Operation Manual; S/M—Service Manual; S/S—Spec Sheet; W/D—Wiring Diagram Manual</p> <p>† Have an authorized service distributor/dealer perform this service.</p>													

Trouble Symptoms										Probable Causes	Recommended Actions	Section or Publication Reference*		
Does not crank	Crankes but does not start	Starts hard	No or low output voltage	Stops suddenly	Lacks power	Overheats	Low oil pressure	High fuel consumption	Excessive or abnormal noise				Displays error message/locks up	Exercise run time and/or event records inoperative
Controller														
x	x											Controller circuit board(s) inoperative	Replace the controller circuit board.	Gen. S/M
				x								Controller fault	Troubleshoot the controller.†	Gen. S/M
x	x			x								Controller fuse blown	Replace the blown controller fuse. If the fuse blows again, troubleshoot the controller.†	Section 2, W/D
x												Controller master switch inoperative	Replace the controller master switch.	—
x												Controller master switch in the OFF/RESET position	Move the controller master switch to the RUN or AUTO position.	Section 2
x												Engine start circuit open	Move the controller master switch to the RUN position to test the generator set. Troubleshoot the auto start circuit and time delays.	Section 2, W/D, Gen. I/M, S/M, ATS O/M, S/M
				x								Voltage regulation inoperative	Replace the controller fuse, if the fuse blows again, troubleshoot the controller.	Section Fuses, Gen. S/M
										x		Controller firmware error	Review the controller display troubleshooting chart.	Section 4.2
											x	Controller clock not set	Reset time and date.	Section 2.9.6, Menu 6
Engine														
x	x				x			x				Air cleaner clogged	Clean or replace the filter element.	Eng. O/M
x	x					x		x				Compression weak	Check the compression.†	Eng. S/M
				x		x		x				Engine overload	Reduce the electrical load. See the generator set spec sheet for wattage specifications.	S/S
									x			Exhaust system leak	Inspect the exhaust system. Replace the inoperative exhaust system components.†	I/M
									x			Exhaust system not securely installed	Inspect the exhaust system. Tighten the loose exhaust system components.†	I/M
												Governor inoperative	Adjust the governor.†	Gen. S/M
									x			Valve clearance incorrect	Adjust the valves.†	Eng. S/M
									x			Vibration excessive	Tighten all loose hardware.	—
	x											Ignition system inoperative (gas/gasoline only)	Check the ignition system (spark plugs, spark plug wires, etc.).	Eng. O/M

* Sec./Section—numbered section of this manual; ATS—Automatic Transfer Switch; Eng.—Engine; Gen.—Generator Set; I/M—Installation Manual; O/M—Operation Manual; S/M—Service Manual; S/S—Spec Sheet; W/D—Wiring Diagram Manual

† Have an authorized service distributor/dealer perform this service.

Trouble Symptoms										Probable Causes	Recommended Actions	Section or Publication Reference*	
Does not crank	Cranks but does not start	Starts hard	No or low output voltage	Stops suddenly	Lacks power	Overheats	Low oil pressure	High fuel consumption	Excessive or abnormal noise				Displays error message/locks up
Cooling System													
						X		X				Clean the air openings.	—
						X						Restore the coolant to normal operating level.	Section 3
						X						Tighten or replace the belt. Replace the water pump.	Eng. O/M or S/M
				X								Allow the engine to cool down. Then troubleshoot the cooling system.	Sec. 3, Eng. O/M
				X								Restore the coolant to normal operating level.	Section 3
												Replace the thermostat.	Eng. S/M
Fuel System													
X	X				X							Bleed the diesel fuel system.	Eng. O/M
X	X											Replace or repair the ether starting system.	Eng. O/M
X				X								Add fuel and move the fuel valve to the ON position.	—
X				X	X			X				Rebuild or replace the injection pump. †	Eng. S/M
X	X			X	X							Clean, test, and/or replace the inoperative fuel injector. †	Eng. S/M
X	X			X	X							Clean or replace the fuel filter.	Eng. O/M
X												Troubleshoot the fuel solenoid. †	Eng. S/M
X				X								Check the fuel supply and valves. †	S/S, Gen. O/M
X	X			X	X			X				Adjust the fuel injection timing. †	Eng. S/M
Lube System													
X	X						X		X			Change the oil. Use oil with a viscosity suitable for the operating climate.	Eng. O/M
						X	X		X			Restore the oil level. Inspect the generator set for oil leaks.	Eng. O/M
												Check the oil level.	Eng. O/M

* Sec./Section—numbered section of this manual; ATS—Automatic Transfer Switch; Eng.—Engine; Gen.—Generator Set; I/M—Installation Manual; O/M—Operation Manual; S/M—Service Manual; S/S—Spec Sheet; W/D—Wiring Diagram Manual

† Have an authorized service distributor/dealer perform this service.

4.2 Controller Display and Voltage Regulation Troubleshooting Chart

Trouble Symptoms	Probable Causes	Recommended Actions	Section or Publication Reference*
Controller Display and Voltage Regulator			
Display is black	No/low battery charge	Recharge/replace battery	Section 3, Battery
Display shows single segment	Low battery voltage	Recharge battery	Section 3, Battery
Display shows an error message	Controller firmware or keypad entry error	Review the Request and Error Message Section	Section 2.6.3
Display shows an EEPROM WRITE ERROR message	EEPROM fault caused by component failure, lightning strike, or voltage spike	Reinitialize the problem data block †	Contact an Authorized Distributor/Dealer
Display locks up	No/low battery charge	Recharge/replace battery	Section 3, Battery
Output voltage ramps	Defective exciter winding	Troubleshoot alternator components †	Generator Service Manual
Output voltage unstable	Voltage regulation calibration incorrect	Readjust voltage regulation †	Menu 11, Voltage Regulator
Speed adjust does not function	Analog input A06 is supported with Doosan, GM, and Volvo engines only	Check calibration values	Menu 12, Calibration
Voltage adjust does not function for paralleling applications	Analog input A07 description does not match <i>Analog Volt Adjust</i>	Change description to <i>Analog Volt Adjust</i> using Monitor III software or enable analog voltage adjust in Menu 11	Monitor Software Manual, Menu 9, Input Setup

* Sec./Section—numbered section of this manual; ATS—Automatic Transfer Switch; Eng.—Engine; Gen.—Generator Set; I/M—Installation Manual; O/M—Operation Manual;
 S/M—Service Manual; S/S—Spec Sheet; W/D—Wiring Diagram Manual

† Have an authorized service distributor/dealer perform this service.

Notes

Section 5 Generator Set Reconnection

5.1 Introduction

Use the following voltage reconnection procedure to change the voltage of 10- and 12-lead generator sets. Frequency changes require voltage regulator *and* governor adjustments. Refer to the respective spec sheet to determine if frequency is fixed or field-convertible. If frequency is adjustable, refer to the engine service manual and/or governor literature for conversion information.

Refer to the following procedure and the connection schematics. Follow the safety precautions at the front of this manual and in the procedure text and observe National Electrical Code (NEC) guidelines.

NOTICE

Voltage reconnection. Affix a notice to the generator set after reconnecting the set to a voltage different from the voltage on the nameplate. Order voltage reconnection decal 246242 from an authorized service distributor/dealer.

Note: Equipment damage. Verify that the voltage ratings of the transfer switch, line circuit breakers, and other accessories match the selected line voltage.

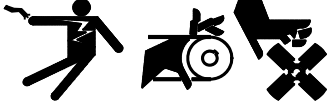
⚠ WARNING

Accidental starting. Can cause severe injury or death. Disconnect the battery cables before working on the generator set. Remove the negative (-) lead first when disconnecting the battery. Reconnect the negative (-) lead last when reconnecting the battery.

Disabling the generator set. Accidental starting can cause severe injury or death. Before working on the generator set or equipment connected to the set, disable the generator set as follows: (1) Turn the generator set master switch and switchgear engine control switch to the OFF position. (2) Disconnect the power to the battery charger. (3) Remove the battery cables, negative (-) lead first. Reconnect the negative (-) lead last when reconnecting the battery. Follow these precautions to prevent the starting of the generator set by an automatic transfer switch or a remote start/stop switch.

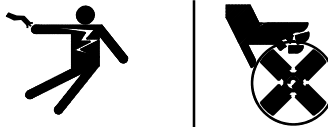
Disabling the generator set. Accidental starting can cause severe injury or death. Before working on the generator set or equipment connected to the set, disable the generator set as follows: (1) Move the generator set master switch to the OFF position. (2) Disconnect the power to the battery charger. (3) Remove the battery cables, negative (-) lead first. Reconnect the negative (-) lead last when reconnecting the battery. Follow these precautions to prevent starting of the generator set by an automatic transfer switch, remote start/stop switch, or engine start command from a remote computer.

⚠ DANGER

Hazardous voltage. Moving parts. Will cause severe injury or death. Operate the generator set only when all guards and electrical enclosures are in place.

Grounding electrical equipment. Hazardous voltage will cause severe injury or death. Electrocutation is possible whenever electricity is present. Ensure you comply with all applicable codes and standards. Electrically ground the generator set, transfer switch, and related equipment and electrical circuits. Turn off the main circuit breakers of all power sources before servicing the equipment. Never contact electrical leads or appliances when standing in water or on wet ground because these conditions increase the risk of electrocution.

Short circuits. Hazardous voltage/current will cause severe injury or death. Short circuits can cause bodily injury and/or equipment damage. Do not contact electrical connections with tools or jewelry while making adjustments or repairs. Remove all jewelry before servicing the equipment.

5.2 Voltage Reconnection Procedure

1. Place the generator set master switch in the OFF/RESET position.
2. Disconnect the generator set engine starting battery, negative (-) lead first. Disconnect power to the battery charger (if equipped).
3. Use Figure 5-1, Figure 5-2, Figure 5-3, or Figure 5-4 to determine the generator set voltage configuration. Note the original voltage and reconnect as needed. Route leads through current transformers (CTs) and connect them according to the diagram for the desired phase and voltage.

Note: Position current transformers CT1, CT2, and CT3 with the dot or HI side CT marking toward the generator set.

4. Reconnect the battery, negative lead last.
5. Go to Menu 14—Programming Mode and select the Program Mode—Local. See Section 2.9.14, Menu 14—Programming Mode, for the complete procedure.
6. Go to Menu 7—Generator System and update the voltage information. See Section 2.9.7, Menu 7—Generator System, for the complete procedure.
7. Go to Menu 12—Calibration and perform the calibration procedure. See Section 2.9.12, Menu 12—Calibration, for the complete procedure.

Note: There is a minimum current that must appear on the screen in Menu 12—Calibration before the user can enter the actual measured value. If the minimum value is not met, a RANGE ERROR code will occur when attempting to change the value. If the unit voltage is 10 kV (medium voltage) or if the unit is 100 kW or less, the minimum value is 25% of the rated current that is displayed in Menu 7—Generator System. If the unit is greater than 100 kW, the minimum value is 50 amps. If the value in Menu 12—Calibration does not meet the minimum criteria mentioned above, the user must increase the test load before the actual measured value can be entered.

8. Go to Menu 11—Voltage Regulator and perform the voltage regulator setup procedure. See Section 2.9.11, Menu 11—Voltage Regulator, for the complete procedure.
9. Move the generator set master switch to the RUN position to start the generator set. Check the digital display for correct voltages using Menu 1—Generator Monitoring.
10. Move the generator set master switch to the OFF/RESET position to stop the generator set after completing the voltage adjustments.
11. Replace the controller cover.
12. Place the generator set master switch in the AUTO or RUN position.

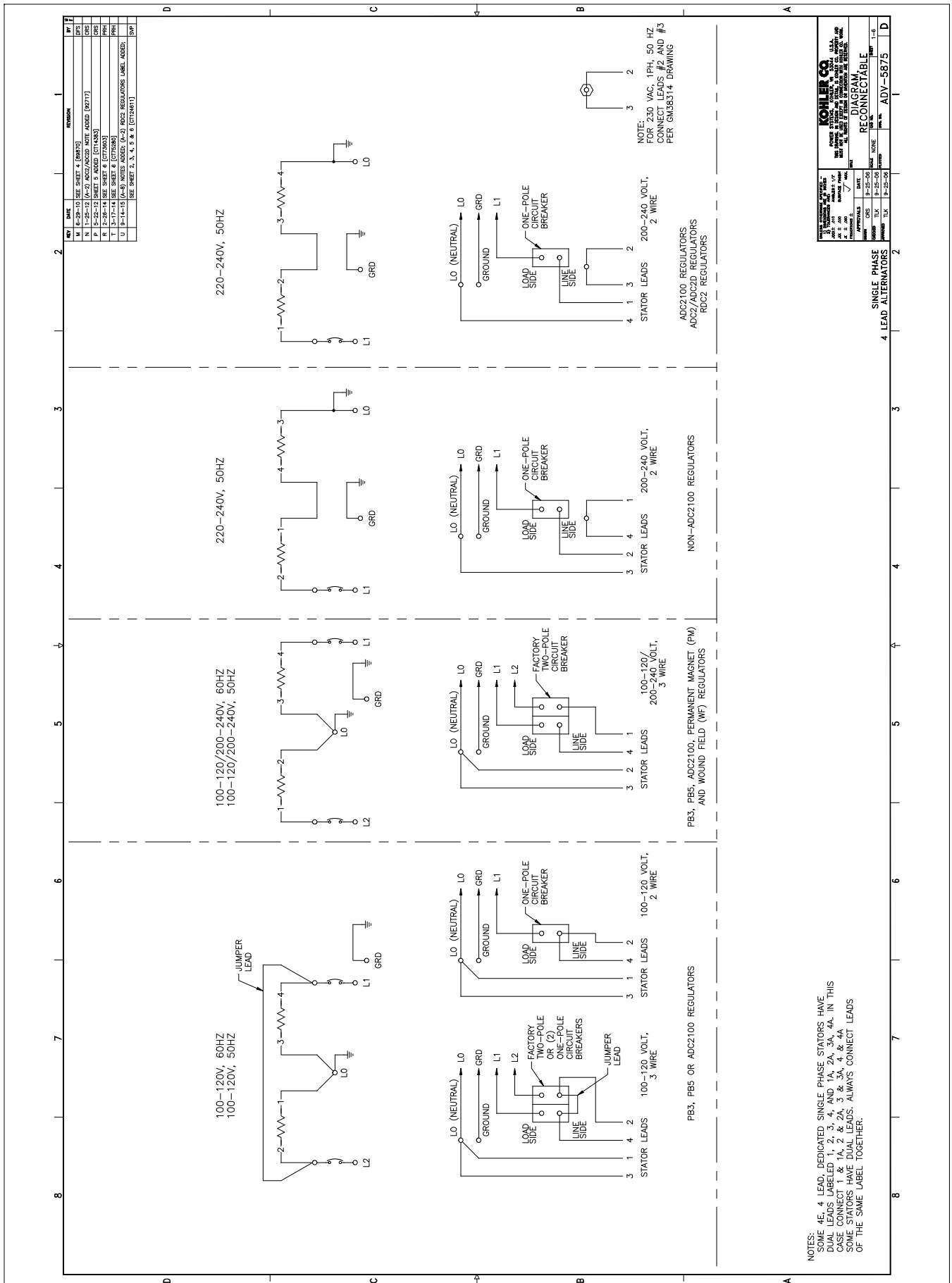

Figure 5-1 20–150 kW Permanent Magnet and Wound Field Single-Phase Alternators, ADV-5875U-1

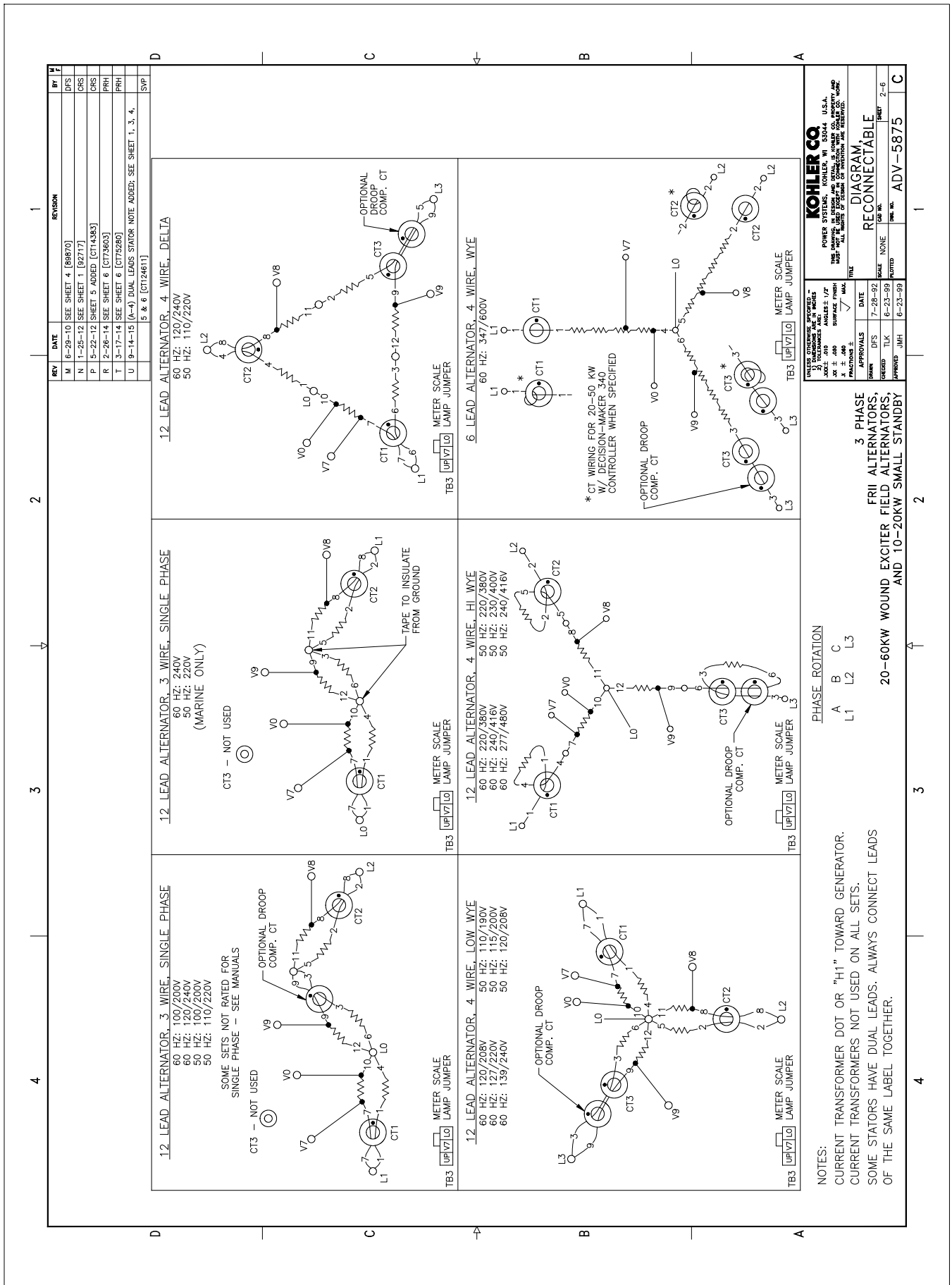

Figure 5-2 20-400 kW Permanent Magnet and 20-60 kW Wound Field Alternators, ADV-5875U-2

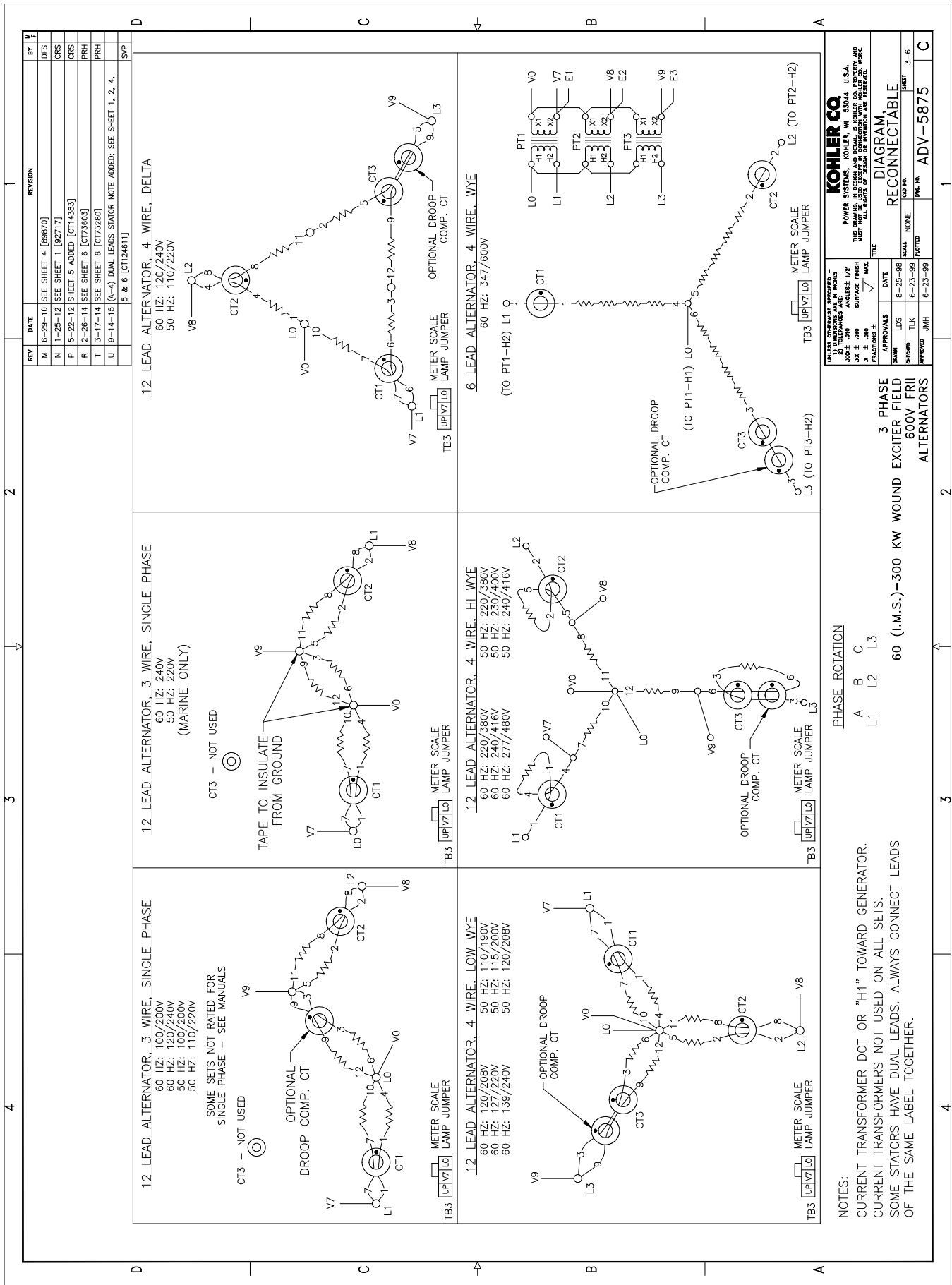

Figure 5-3 60 (with Oversize Alternator)-400 kW Wound Field Alternators, ADV-5875U-3

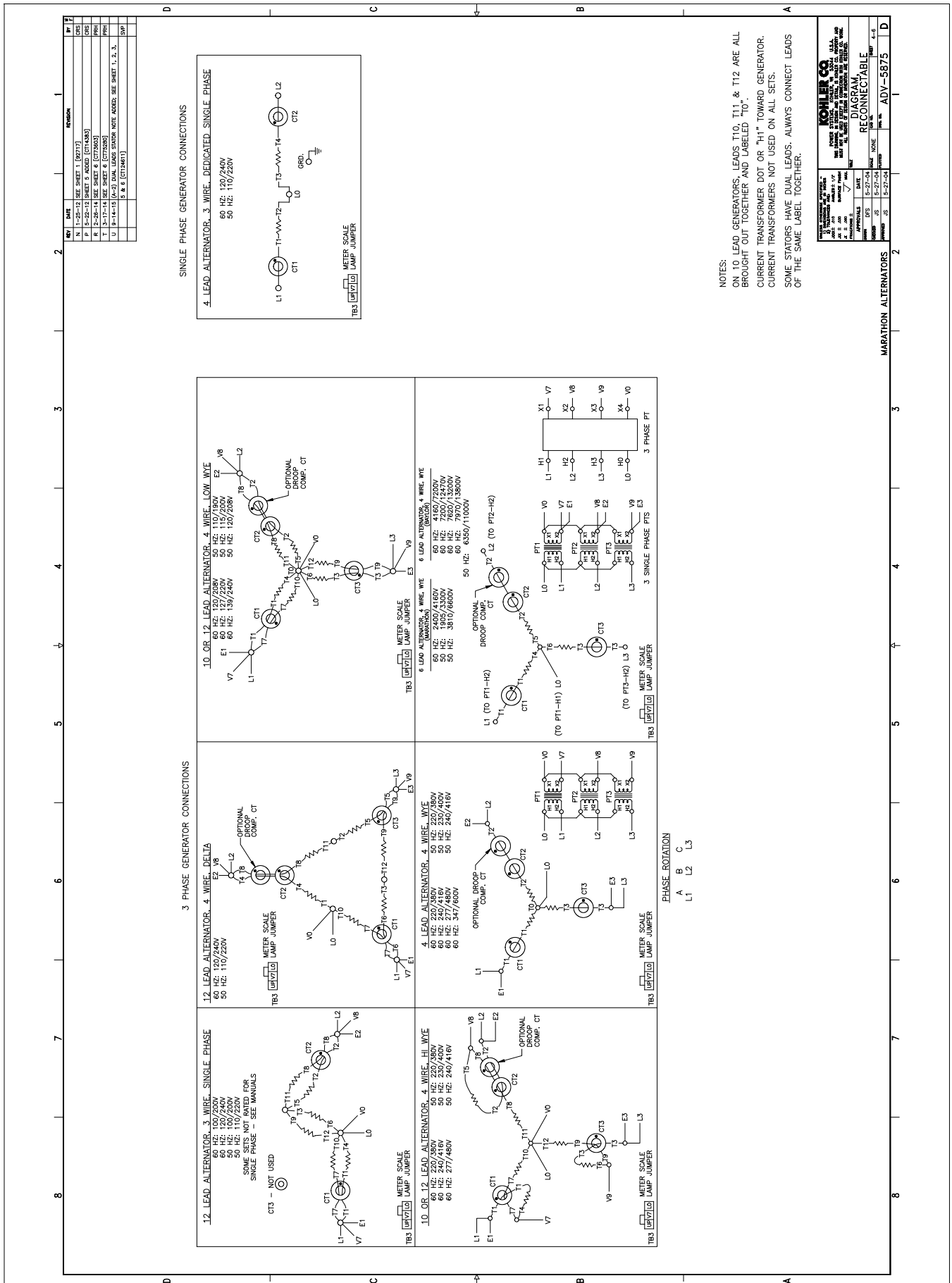

Figure 5-4 350 kW and Larger Pilot-Excited, Permanent Magnet Alternator, ADV-5875U-4

6.1 Accessories and Connections

Several accessories help finalize installation, add convenience to operation and service, and establish state and local code compliance.

Accessories vary with each generator set model and controller. Select factory-installed and/or shipped-loose accessories. See Figure 6-1 for a list of available kits. Obtain the most current accessory information from your local authorized service distributor/dealer.

This section illustrates several accessories available at print time of this publication. Accessory kits generally include installation instructions. See wiring diagrams manual for electrical connections not shown in this section. See the installation instructions and drawings supplied with kit for information on kit mounting location.

The instructions provided with the accessory kit supersede these instructions where there are differences. In general, run AC and DC wiring in separate conduit. Use shielded cable for all analog inputs. Observe all applicable national, state, and local electrical codes during accessory installation.

6.1.1 Audiovisual Alarm Kit

An audiovisual alarm warns the operator at a remote location of fault shutdowns and prealarm conditions. Audiovisual alarms include an alarm horn, an alarm silence switch, and common fault lamp. See Figure 6-2 and Figure 6-3. See Section 6.2, Accessory Connections, for terminal identification.

Note: Use the audiovisual alarm with a dry contact kit.

Kit Description
Audiovisual Alarm
Common Failure Relay (Terminal 32A)
Controller (Customer) Connection
Battery Charger (with alarms)
Ground Fault Annunciation
Idle (Speed) Mode Feature
Low Fuel (Level) Switch
Low Fuel (Pressure) Switch
Prime Power Switch
Remote Emergency Stop
Remote Reset Feature
Remote Serial Annunciator (RSA III)
Remote Speed Adjust Kit (ECM Models only)
Remote Speed Adjustment Potentiometer (requires electronic governor), Non-ECM Models only
Run Relay
Shunt-Trip Line Circuit Breaker and Shunt-Trip Wiring
Single-Relay Dry Contact
Ten-Relay Dry Contact
Twenty-Relay Dry Contact
Wireless Monitor

Figure 6-1 Optional Accessories

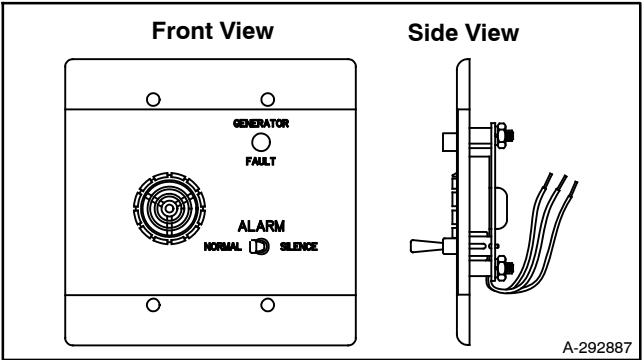

Figure 6-2 Audiovisual Alarm

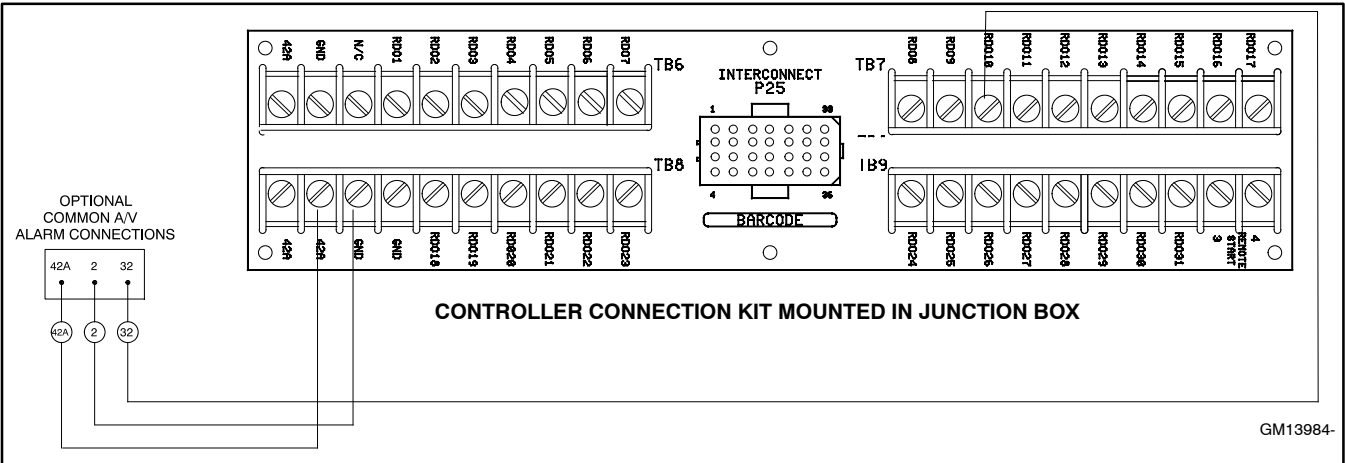

Figure 6-3 Audiovisual Alarm Connections

6.1.2 Common Failure Relay Kit

The common failure relay kit provides one set of contacts to trigger user-provided warning devices if a fault occurs. The common failure relay faults are user-defined. See Section 2, Operation, Menu 10—Output Setup, for status and faults available for this function.

Connect up to three common failure relay kits to the controller output. See Figure 6-4 and Figure 6-5. See Section 6.2, Accessory Connections, for terminal identification.

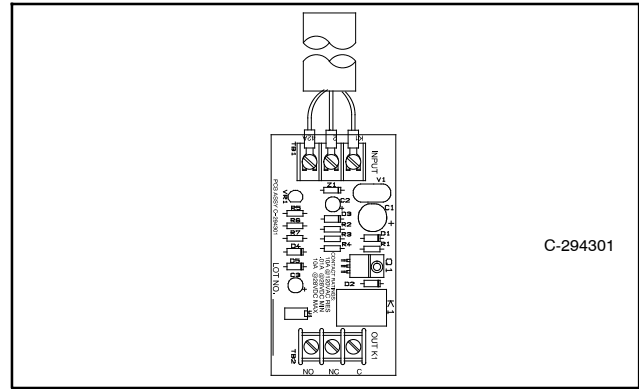

Figure 6-4 Common Failure Relay Kit

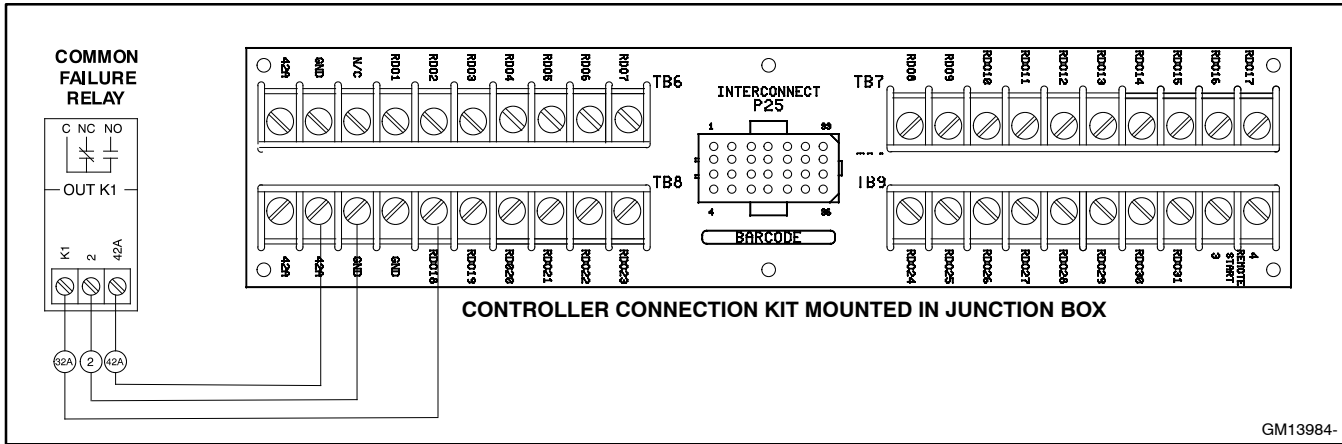

Figure 6-5 Common Failure Relay Kit Connections

6.1.3 Battery Charger Kit with Alarm Option

The battery charger with alarm option provides battery charging to the engine starting battery(ies) and connects to the controller for fault detection. Battery chargers for 12- or 24-volt models are available as a

generator set accessory. See Figure 6-6. See Section 6.2, Accessory Connections, for terminal identification.

Note: On charger GM87448, the Battery Charger Fault is communicated through CAN communication and the connection on TB4 is not used.

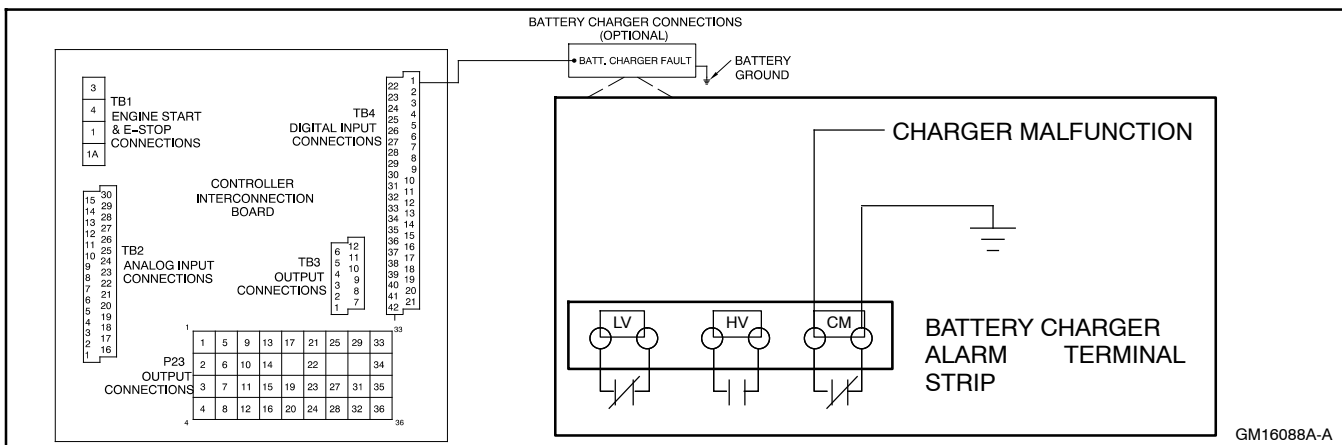

Figure 6-6 Battery Charger Connections

6.1.4 Controller (Customer) Connection Kit

The controller connection kit allows easy connection of controller accessories without accessing the controller terminal strip. The supplied wiring harness connects controller connector P23 and terminal strips TB1-3 and

TB1-4 to the controller connection kit connector P25 and terminal strips TB6, TB7, TB8, and TB9. Connect all accessories (except the emergency stop kit) to the controller connection kit terminal strips. See Figure 6-7. See Section 6.2, Accessory Connections, for terminal identification.

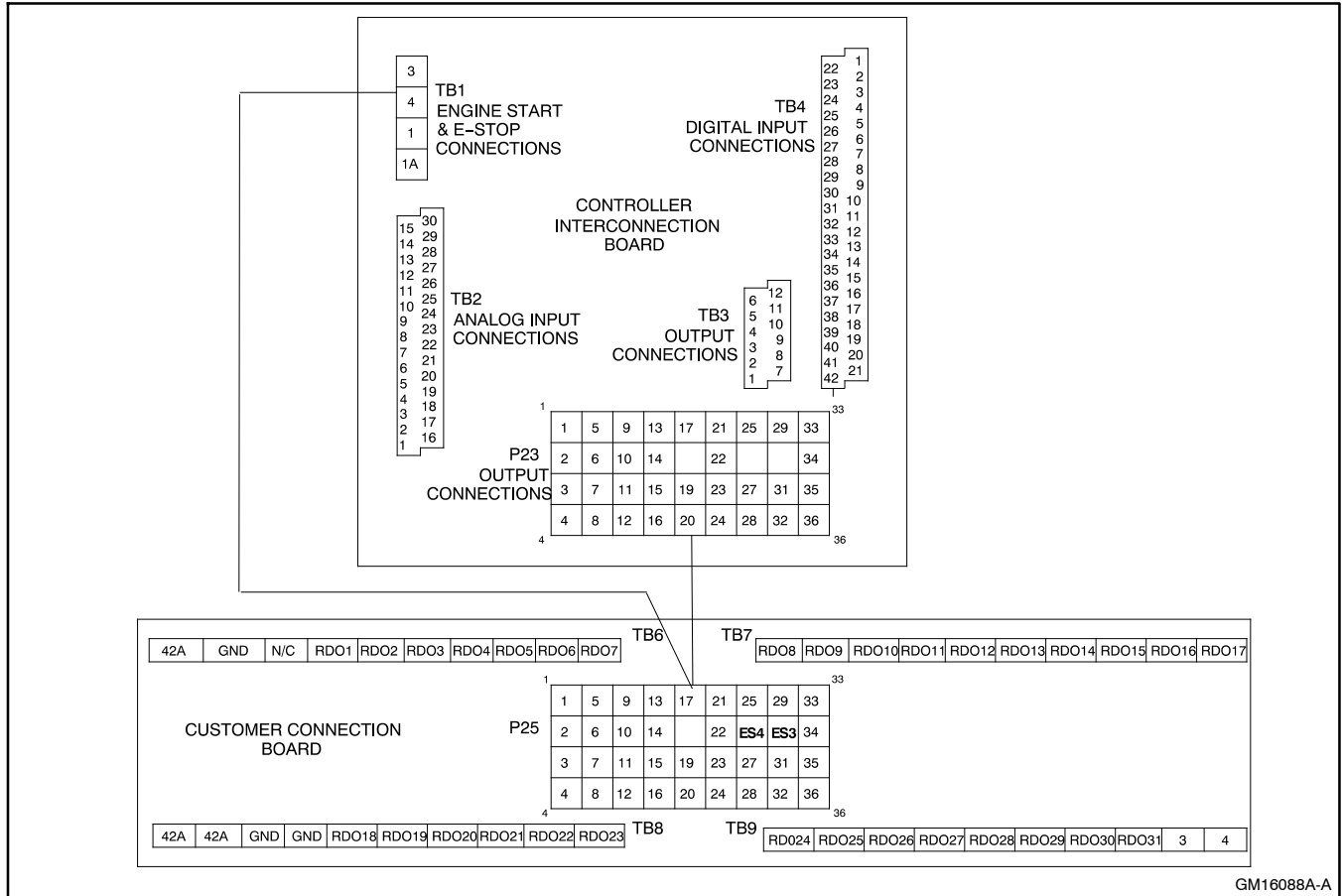

Figure 6-7 Controller (Customer) Connection Kit

6.1.5 Ground Fault Annunciation

A relay contact for customer connection indicates a ground fault condition and is part of a ground fault alarm. See Figure 6-8 for electrical connections and the following procedure for controller setup. Use the instructions with the kit when provided to install and setup this accessory.

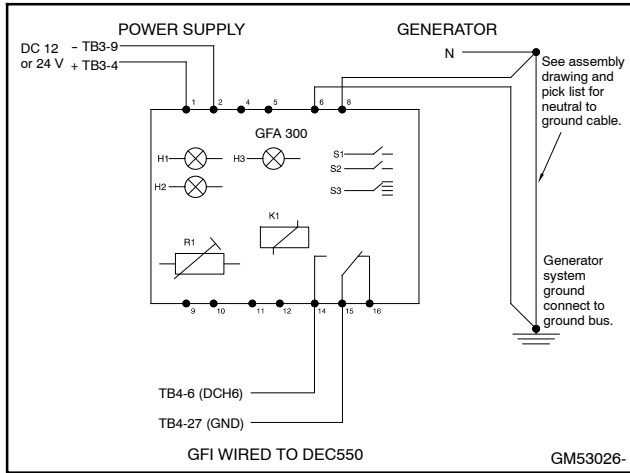
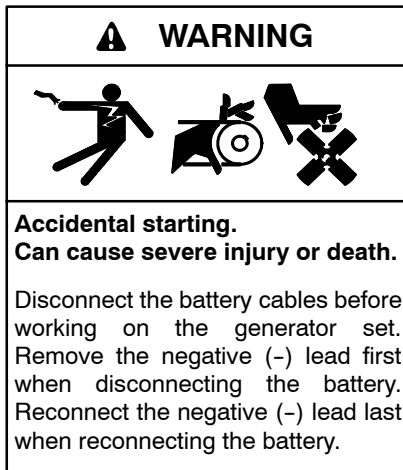

Figure 6-8 Ground Fault Connections



Disabling the generator set. Accidental starting can cause severe injury or death. Before working on the generator set or equipment connected to the set, disable the generator set as follows: (1) Move the generator set master switch to the OFF position. (2) Disconnect the power to the battery charger. (3) Remove the battery cables, negative (-) lead first. Reconnect the negative (-) lead last when reconnecting the battery. Follow these precautions to prevent starting of the generator set by an automatic transfer switch, remote start/stop switch, or engine start command from a remote computer.

Ground Fault Controller Setup Procedure

1. Reconnect battery, if not already done.
2. Place the controller master switch to the AUTO position.
3. Press the Alarm Off key to silence the alarm horn, if necessary.
4. If the programming mode LED is not flashing, go to the step 5. If the programming mode LED is flashing, go to step 6.
5. Set Programming Mode to Local.

a. Press keys .

b. Press key until *Programming Mode-Local* is displayed.

c. Press the YES key .

d. When the *Enter Code* displays, press the factory default or the user password keys and . The programming mode LED should be flashing.

6. Set digital input #6 to ground fault.

a. Press . *Menu 9 Input Setup* should be displayed.

b. Press until *Digital Input 06 Warning* is displayed.





c. Press once to select this input.

d. Press until *Ground Fault* is displayed.

e. Press to define Digital Input #06 as ground fault. *Entry Accepted* is displayed.

f. Press to display *Digital Input #06 Inhibit Time*.











g. Press to enter the inhibit time. *Entry Accepted* is displayed and the inhibit time 0:00 is now displayed.

- h. Press  to display *Digital Input #06 Delay Tlme.*
- i. Press   to enter delay time. *Entry Accepted* is displayed. Default delay time is 5 sec.
- j. Press .

7. Verify Programming.

- Move handle of ground fault circuit breaker at generator set to simulate a ground fault.
- Verify that display shows *D06 Ground Fault*. The System Warning LED should be illuminated and the alarm horn should sound. If these indicators are not present, recheck steps 6a. through 6j.
- Return handle of ground fault circuit breaker to the non-ground fault position. *D06 Ground Fault* display should now be cleared.

8. Set Programming Mode to Off.

- Press    .
 - Press key  until *Programming Mode Off* is displayed.
 - Press the YES key  .
 - When the *Enter Code* displays, press the factory default   or the user password keys and . The programming mode LED should now be off.
- Place the controller master switch to the OFF/RESET position.
 - Disconnect the battery negative (-) lead to power down the generator set.
 - After 2-3 minutes, reconnect the battery negative (-) lead.
 - Reset the controller clock. See Menu 6—Time and Date.

6.1.6 Idle (Speed) Mode Feature

The idle (speed) mode feature provides the ability to start and run the engine at idle (reduced) speed for a selectable time period (0–10 minutes) during warm-up. See Figure 6-9 for user-supplied switch connection.

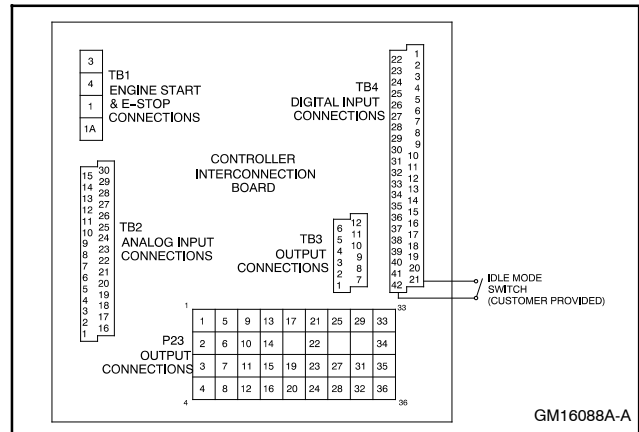

Figure 6-9 Idle (Speed) Mode Switch

The controller will override the idle speed mode when the engine reaches the preprogrammed engine warm-up temperature before the idle mode times out.

The idle function also provides engine cooldown at idle speed. The controller overrides the idle speed mode when the engine reaches the preprogrammed engine cooldown temperature before the idle mode times out.

During the idle (speed) mode the controller continues to monitor critical engine parameters such as oil pressure, coolant temperature, and engine speed. The voltage regulator, thermal protection feature, and AC metering are disabled in the idle speed mode.

To start warm up, the master switch must be in the AUTO position. Activate the idle model input by closing the contacts at the auxiliary digital input assigned to Idle Mode D21 by default). The generator set will run at idle speed until the engine coolant temperature reaches the pre-programmed warm-up temperature, at which point the engine will run at normal speed.

If the idle delay is set in infinite (9:99), the generator set will not transition to normal speed and it will continue to run at idle speed until the idle input is de-activated.

To stop the generator set that was started by activating the idle mode input (master switch in AUTO), simply deactivate the idle mode input by opening the contacts at this input.

If the Idle Delay is set for infinite operation (Idle delay = 9:99) the generator set will continue running at idle speed until the idle input is de-activated. When the idle mode contacts open, the generator set will immediately shut down.

If the Idle Delay is not set for infinite operation (Idle delay = 0–10 minutes), the generator set will transition to the Cooldown state when the idle input is de-activated. The generator set will run at idle speed until the engine coolant temperature falls below the pre-programmed cooldown threshold or until the programmable idle time delay expires, whichever occurs first. If the Cooldown Override parameter is set to TRUE, the coolant temperature will be ignored and the cooldown will continue for the entire idle delay.

If the remote start input is re-activated during the cooldown cycle, the cooldown will abort and normal generator set operation will resume.

If the idle delay is set to 0, the idle input will behave much like the remote start input.

Note: Idle operation is only available on generator set models equipped with an electronic ECM. Further, certain engines do not support idle operation. Consult the factory for more information.

6.1.7 Low Fuel (Level/Pressure) Switch

Some gaseous-fueled models offer a low fuel pressure switch. The low fuel pressure switch connects to the same terminal as the low fuel level switch on diesel- or gasoline-fueled models. See Figure 6-10 and Figure 6-11. See Section 6.2, Accessory Connections, for terminal identification.

Note: The main tank or the transfer/day tank includes the low fuel level switch. The fuel tank supplier typically provides the low fuel level switch.

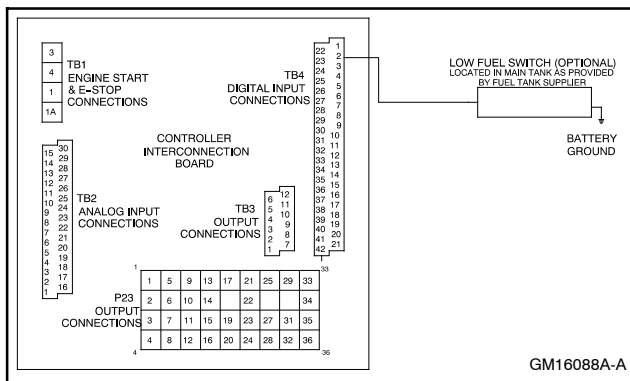

Figure 6-10 Low Fuel Switch (Level or Pressure)

Switch Rating	12 volts DC minimum, 0.5 amp minimum
Wiring Recommendation	
Gauge	mm (ft.)
18-20	30.5 (100)
14	153 (500)
10	305 (1000)

Figure 6-11 Switch Rating & Wiring Recommendation

6.1.8 Prime Power Switch Kit

The prime power switch kit prevents battery drain during generator set nonoperation periods and when the generator set battery cannot be maintained by an AC battery charger. See Figure 6-12 for an illustration of the kit and Figure 6-13 for the electrical connections.

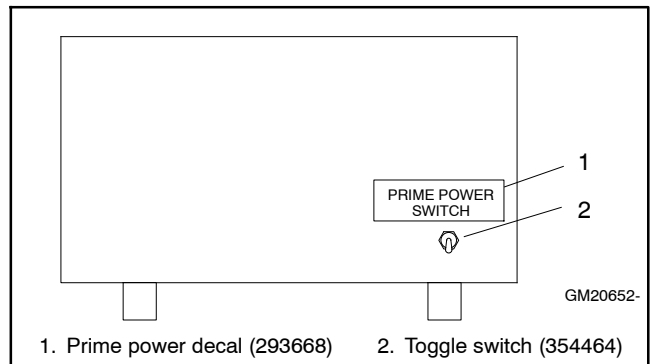

Figure 6-12 Prime Power Switch Installation Location

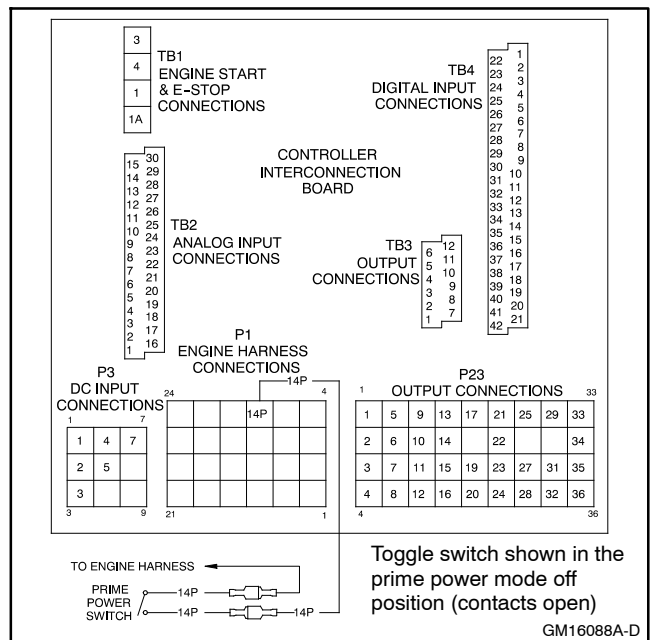

Figure 6-13 Prime Power Switch Connections

Stop the generator set using the stopping procedures in Section 2.4.2, Stopping, before placing the generator set in the prime power OFF mode. Move the prime power switch located on the back of the controller to the DOWN position. The controller including the digital display, LEDs, and alarm horn does not function when the generator set is in the prime power OFF mode.

Move the prime power switch located on the back of the controller to the UP position to place the generator set in the prime power ON mode. Reset the controller time and date before attempting to start the generator set.

6.1.9 Remote Emergency Stop Kit

The emergency stop kit allows immediate shutdown of the generator set from a remote location. See Figure 6-14 and Figure 6-15. If the emergency stop switch activates, the EMERGENCY STOP lamp lights and the unit shuts down. Before attempting to restart the generator set, reset the emergency stop switch (by replacing the glass piece) and reset the generator set by placing the master switch in the OFF/RESET position.

Use the single glass piece located inside the switch for replacement and order additional glass pieces as service parts. See Section 2.4.3, Emergency Stop Switch Reset Procedure. See Section 6.2, Accessory Connections, for terminal identifications.

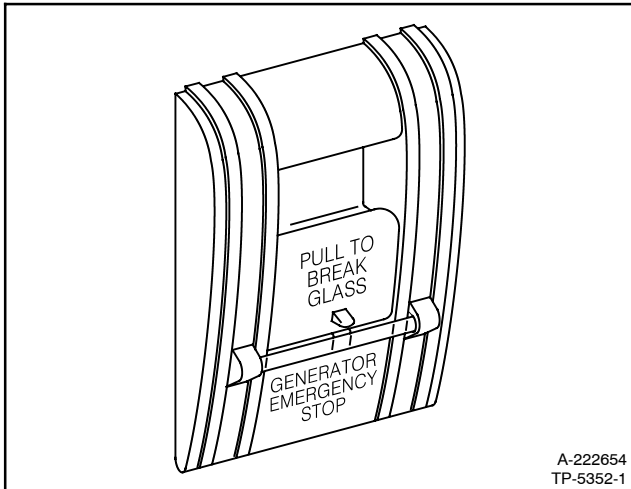

Figure 6-14 Emergency Stop Kit

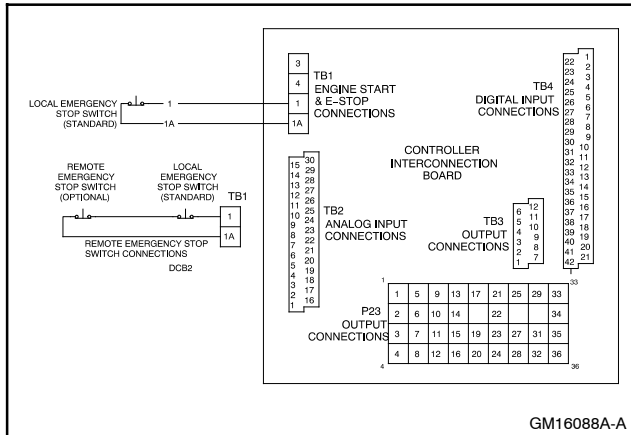

Figure 6-15 Remote Emergency Stop Kit Connections

6.1.10 Remote Reset Feature

The remote reset switch provides generator set resetting after a fault shutdown at a remote location. See Figure 6-16 and Figure 6-17 for user-supplied switch connection.

Press and hold the switch for 2-3 seconds and release to reset the generator set controller.

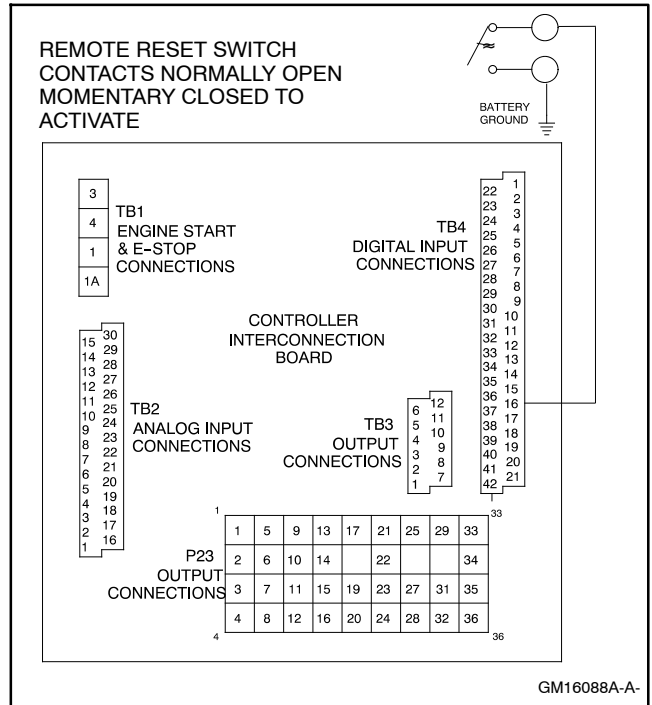

Figure 6-16 Remote Reset Switch Connections

Switch Rating	12 volts DC minimum, 1 amp minimum
Wiring Recommendation	
Gauge	mm (ft.)
18-20	30.5 (100)
14	153 (500)
10	305 (1000)

Figure 6-17 Switch Rating and Wiring Recommendations

6.1.11 Remote Serial Annunciator (RSA)

RSA III is an annunciator panel offered in several kit configurations to support Kohler power equipment. The RSA III is a remote serial annunciator (Figure 6-18, Figure 6-19, and Figure 6-20) that monitors the condition of the generator set and/or ATS from a remote location. The RSA III alerts the operator through visual and audible signals using LED indication and a horn. An alarm silence and lamp test switch are included. An alarm silence and lamp test switch are included.

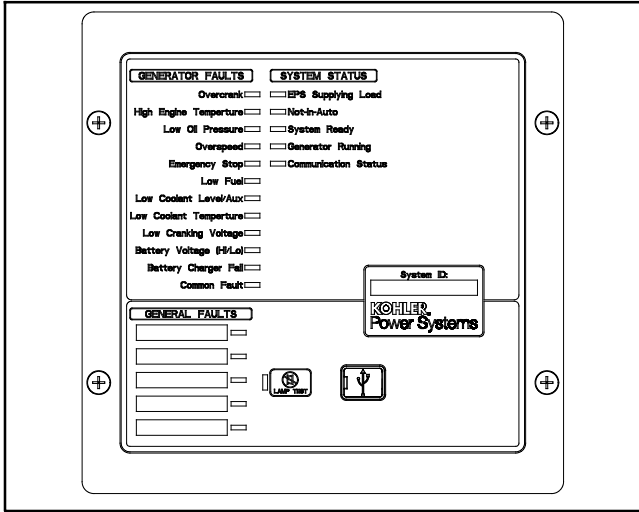

Figure 6-18 Remote Serial Annunciator (RSA III)

The RSA III meets NFPA 110, Level 1 applications that require remote controls and alarms be powered by a storage battery such as the engine starting battery. AC adaptor kit GM62466-KP1 is available when NFPA is not required.

The front panel decals include areas that can be used to identify user-selected fault inputs and identify associated power system equipment.

An RSA III annunciator can be used for a single generator set or with a combination of a generator set and automatic transfer switch. In systems using more than a single RSA III, one must be designated as the master device to broadcast to additional RSA III annunciators, designated as slave devices. Up to five RSA III slave devices can be used with an RSA III master device. All RSA III annunciators are factory set as the master device, but can be changed to a slave device using a PC and SiteTech™ software that connects to the RSA III front panel via a universal serial bus (USB) connection.

The RSA II and RSA 1000 can be connected with the RSA III provided that the master remote annunciator is an RSA III.

Refer to TT-1625 Remote Serial Annunciator (RSA III) Kits for operation and installation instructions.

See Section 6.2, Accessory Connections, for terminal identifications.

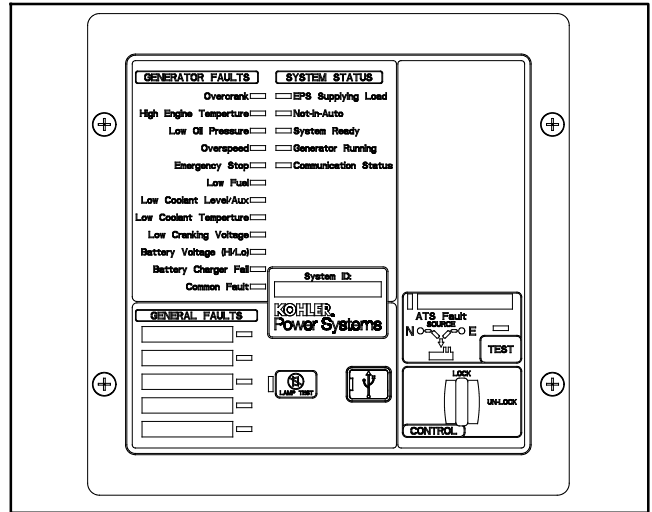

Figure 6-19 RSA III with Single ATS Control

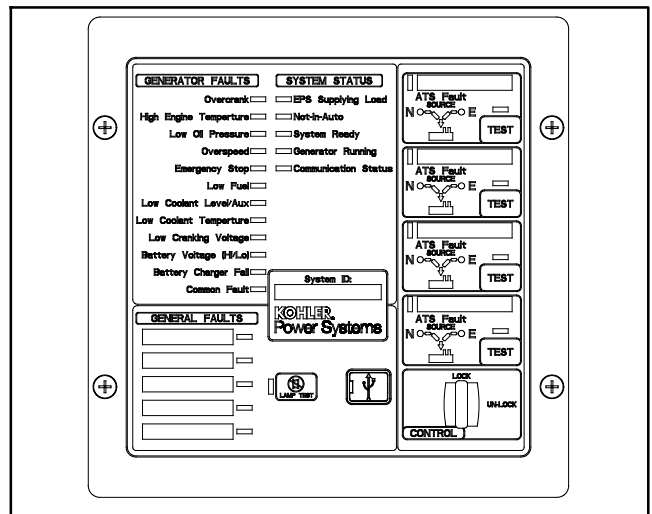

Figure 6-20 RSA III with Four ATS Controls

A PC with SiteTech™ software is required to make the RSA III functional. Use your SecurID to access KOHLERnet, click on the TechTools button, and follow the instructions to download the files. See SiteTech™ Software Settings and refer to TP-6701 SiteTech™ Software Operation Manual for more information.

The RSA III kits include components for surface mounting or flush mounting.

Figure 6-21 shows the status of the system ready LED, generator set running LED, communication status LED, common fault LED, common fault output, and horn for each fault or status condition.

If a fault occurs, the RSA III horn activates and the corresponding LED illuminates.

If the RSA III is used with an Ethernet communication network, order Modbus® Ethernet converter GM41143-KP2 and refer to TT-1405 Converters, Connections, and Controller Setup for Network Communication for system installation.

Fault and Status Condition	Fault LED	System Monitoring LEDs and Functions					
		System Ready LED	Generator Running LED	Communications Status LED	Common Fault LED	Common Fault Output	Horn
Overcrank (Shutdown)	Red SF	Red SF	Off	Green	Red SF	On	On
High Engine Temperature (Warning)	Yellow SF	Red SF	Green	Green	Red SF	On	On
High Engine Temperature (Shutdown)	Red SF	Red SF	Off	Green	Red SF	On	On
Low Oil Pressure (Warning)	Yellow SF	Red SF	Green	Green	Red SF	On	On
Low Oil Pressure (Shutdown)	Red SF	Red SF	Off	Green	Red SF	On	On
Overspeed (Shutdown)	Red SF	Red SF	Off	Green	Red SF	On	On
Emergency Stop	Red SF	Red SF	Off	Green	Off	On	On
Low Coolant Level/Aux (Shutdown)	Red SF	Red SF	Off	Green	Red SF	On	On
Low Coolant Temperature	Yellow SF	Red SF	Green or Off	Green	Red SF	On	On
Low Fuel	Yellow SF	Red SF	Green or Off	Green	Red SF	On	On
Low Cranking Voltage	Yellow SF	Red SF	Off	Green	Red SF	On	On
Battery Charger Fail	Yellow SF	Green	Green or Off	Green	Off	On	On
Battery Voltage (Hi)	Yellow SF	Green	Green or Off	Green	Off	On	On
Battery Voltage (Lo)	Yellow SF	Green	Green or Off	Green	Off	Off	Off
Common Fault (Warning)	Yellow SF	Green	Green or Off	Green	Red SF	On	Off
Common Fault (Shutdown)	Red SF	Green	Green or Off	Green	Red SF	On	On
User Input #1 (Warning)	Yellow SF	Green	Green or Off	Green	Off	Off	Off
User Input #1 (Shutdown)	Red FF	Green	Green or Off	Green	Off	On	On
User Input #2 (Warning)	Yellow SF	Green	Green or Off	Green	Off	Off	Off
User Input #2 (Shutdown)	Red FF	Green	Green or Off	Green	Off	On	On
User Input #3 (Warning)	Yellow SF	Green	Green or Off	Green	Off	Off	Off
User Input #3 (Shutdown)	Red FF	Green	Green or Off	Green	Off	On	On
User Input #4 (Warning)	Yellow SF	Green	Green or Off	Green	Off	Off	Off
User Input #4 (Shutdown)	Red FF	Green	Green or Off	Green	Off	On	On
User Input #5 (Warning)	Yellow SF	Green	Green or Off	Green	Off	Off	Off
User Input #5 (Shutdown)	Red FF	Green	Green or Off	Green	Off	On	On
ATS Position N (RSA III with ATS only)	Green	Green	Green or Off	Green	Off	Off	Off
ATS Position E (RSA III with ATS only)	Red	Red SF	Green or Off	Green	Off	Off	Off
ATS Available N (RSA III with ATS only)	Green	Green	Green or Off	Green	Off	Off	Off
ATS Available E (RSA III with ATS only)	Red	Red SF	Green or Off	Green	Off	Off	Off
ATS Test (RSA III with ATS only, Test initiated at ATS)	Yellow	Green	Green or Off	Green	Off	Off	On
ATS Test (RSA III with ATS only, Test initiated at RSA)	Green	Green	Green or Off	Green	Off	Off	On
ATS Fault (RSA III with ATS only, No fault)	Green	Green	Green or Off	Green	Off	Off	On
ATS Fault (RSA III with ATS only, With fault)	Red FF	Red SF	Green or Off	Green	Off	Off	On
EPS Supplying Load	Green	Green	Green or Off	Green	Off	Off	Off
Not-In-Auto	Red FF	Red SF	Off	Green	Red SF	On	On
Communication Status (Loss - Master)	Red FF	Off	Off	Red FF	Off	On	On
Communication Status (Loss - Slave)	Red SF	Off	Off	Red SF	Off	On	On

Note: SF = Slow Flash (once per second), FF = Fast Flash (five times per second)

Figure 6-21 System Monitoring LEDs and Functions

6.1.12 Remote Speed Adjust Kit (ECM Models)

This kit provides remote engine speed adjustments with an approximate range of $\pm 5\%$ at 1800 rpm. See Figure 6-22 and Figure 6-23.

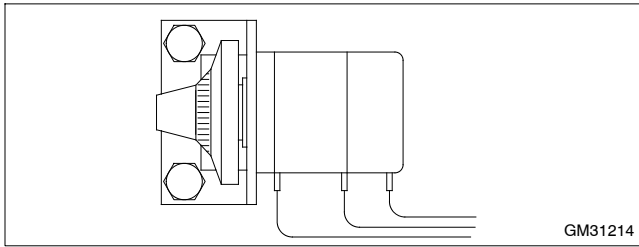

Figure 6-22 Remote Speed Adjusting Control

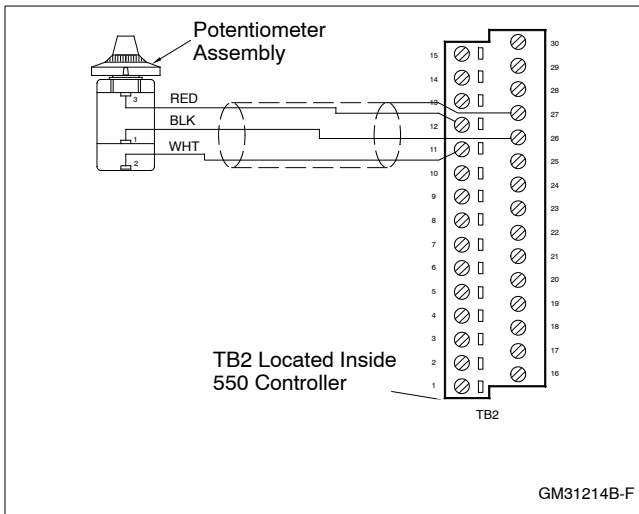

Figure 6-23 Speed Adjusting Control Wiring Diagram

6.1.13 Remote Speed Adjustment Potentiometer Kit (Non-ECM Models)

The remote speed adjustment potentiometer kit provides controller-mounted engine speed adjustment. The adjustment range is approximately $\pm 5\%$. Some applications locate this potentiometer with the switchgear. This kit requires an electronic governor on the generator set. See Figure 6-24. See Section 6.2, Accessory Connections, for terminal identifications.

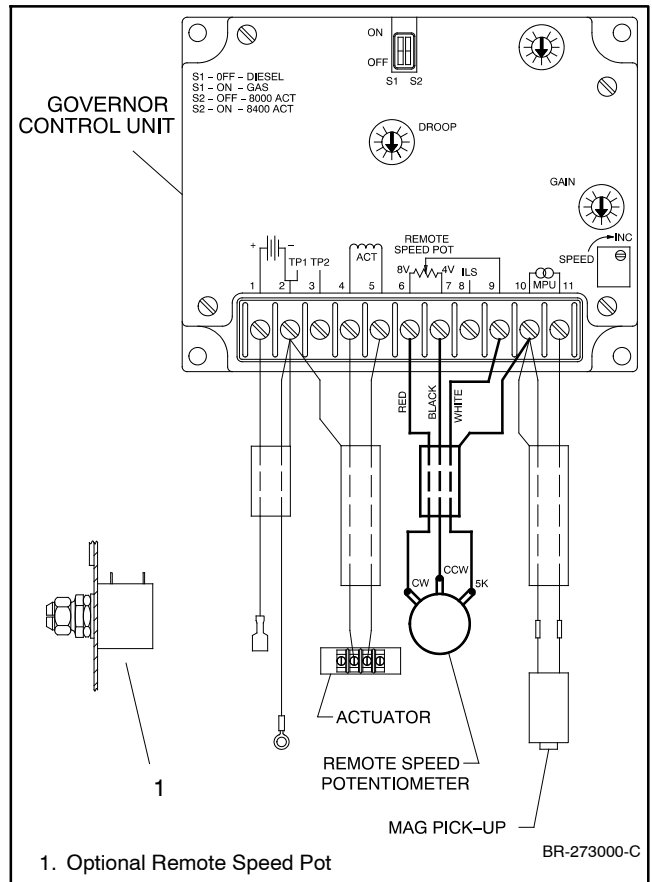

Figure 6-24 Remote Speed Adjustment Potentiometer Connection, Typical

6.1.14 Run Relay Kit

The run relay kit energizes only when the generator set runs. Use the run relay kit to control air intake and radiator louvers, alarms, and/or other signalling devices. See Figure 6-25 and Figure 6-26.

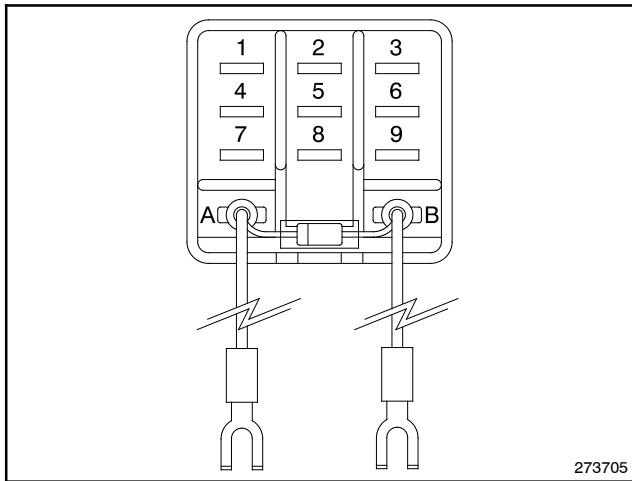

Figure 6-25 Run Relay Kit

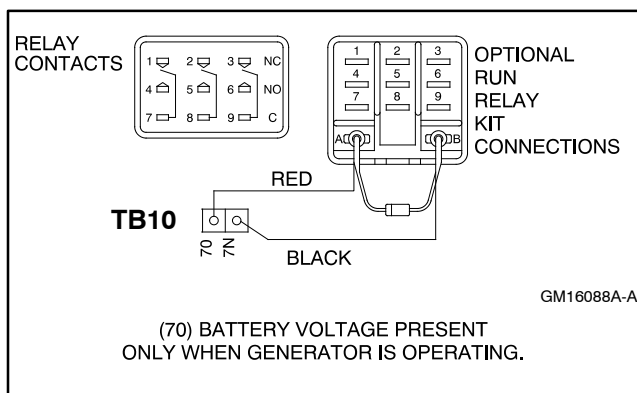

Figure 6-26 Run Relay Connections

6.1.15 Shunt-Trip Line Circuit Breaker

A shunt-trip line circuit breaker provides a 12- or 24-DC volt solenoid within the line circuit breaker case that can energize the trip mechanism. This feature allows the circuit breaker to be tripped by a customer-selected fault such as alternator overload, overspeed, overvoltage, or defined common fault. Connection requires a shunt-trip wiring kit and a dry contact kit. See Figure 6-27.

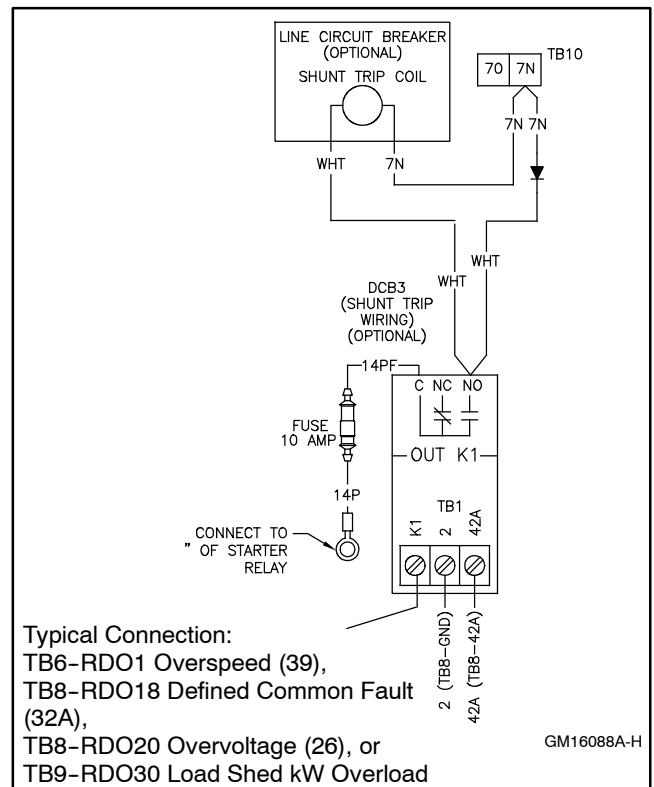

Figure 6-27 Shunt-Trip Line Circuit Breaker and Shunt-Trip Wiring Kit Connections

6.1.16 Single-Relay Dry Contact Kit

The single-relay dry contact kit provides normally open and normally closed contacts in a form C configuration to activate warning devices and other user-provided accessories allowing remote monitoring of the generator set. Typically, lamps, audible alarms, or other devices signal faults or status conditions. Connect any controller fault output to the single-relay dry contact kit.

A total of three dry contact kits may connect to a single controller output. See Figure 6-28 and Figure 6-29. See Section 6.2, Accessory Connections, for terminal identifications.

6.1.17 Ten-Relay Dry Contact Kit

The ten-relay dry contact kit provides normally open and normally closed contacts in a form C configuration to activate warning devices and other user-provided accessories allowing remote monitoring of the generator set. Connect any controller fault output to the ten-relay dry contact kit. Typically, lamps, audible alarms, or other devices signal the fault conditions.

Refer to Figure 6-30 for an internal view of the contact kit. See Figure 6-31 for electrical connections. See Section 6.2, Accessory Connections, for terminal identifications.

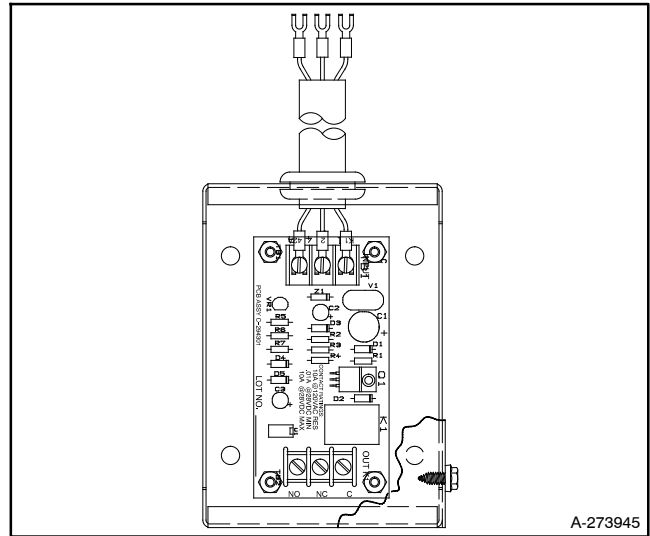

Figure 6-28 Single-Relay Dry Contact Kit, Typical

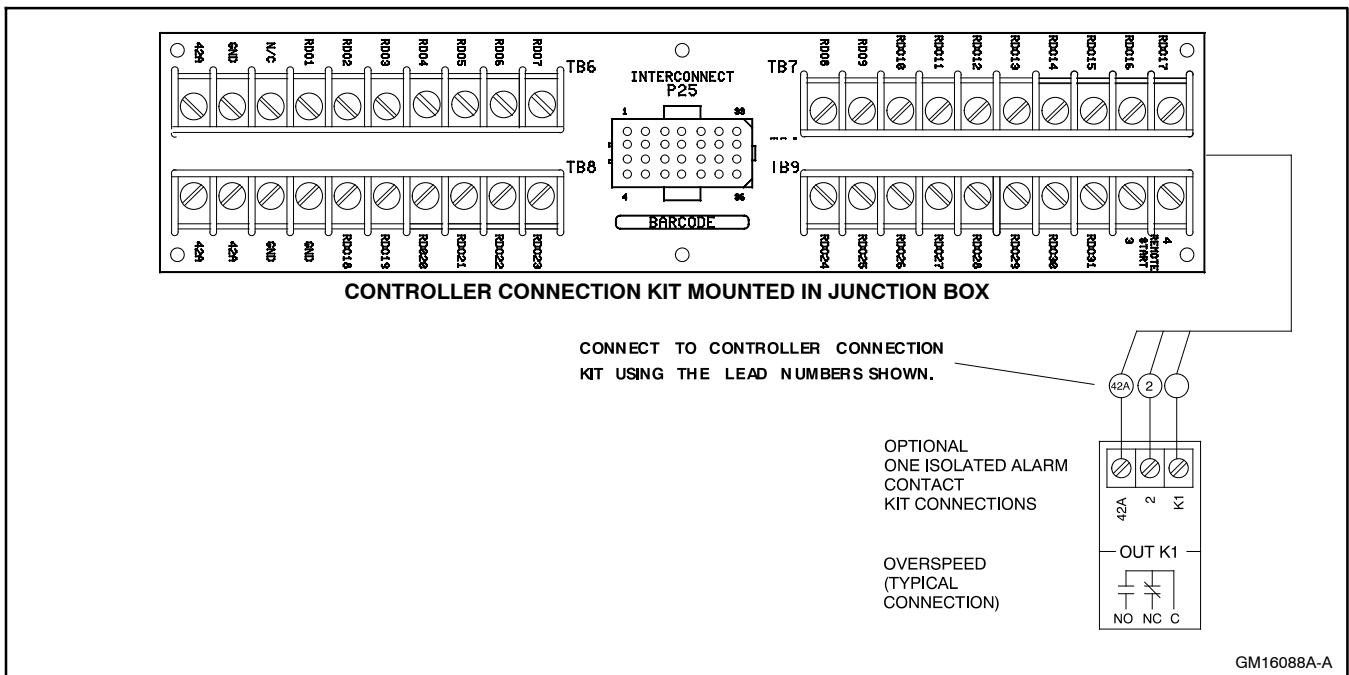

Figure 6-29 Single-Relay Dry Contact Kit Connections

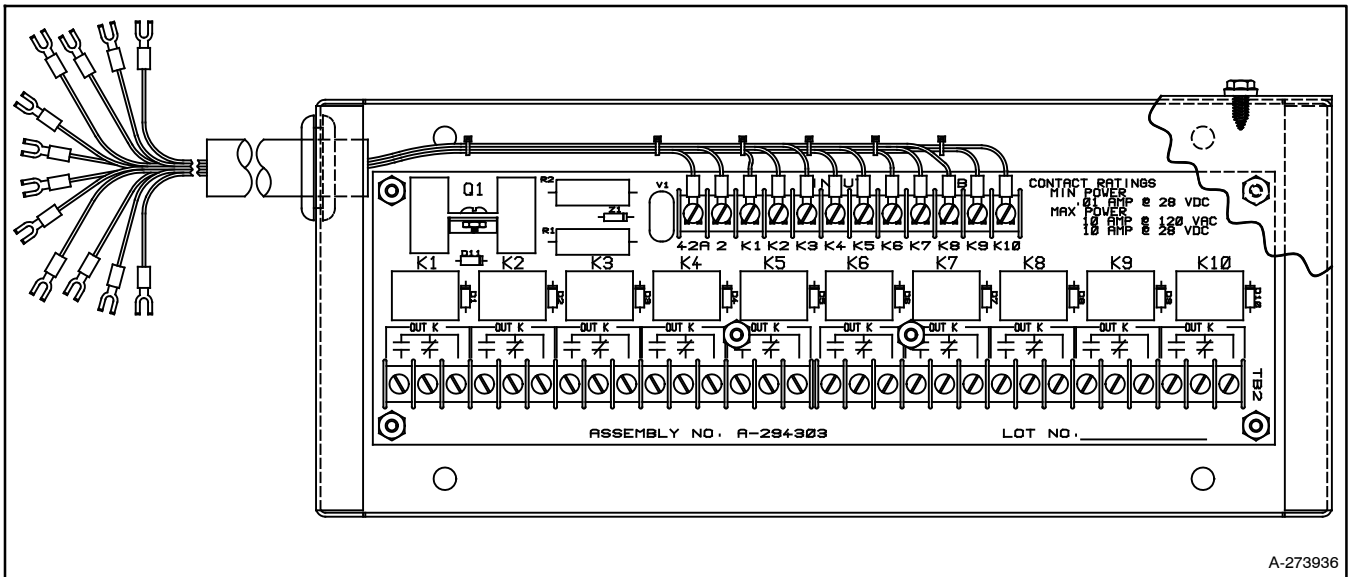

Figure 6-30 Ten-Relay Dry Contact Kit

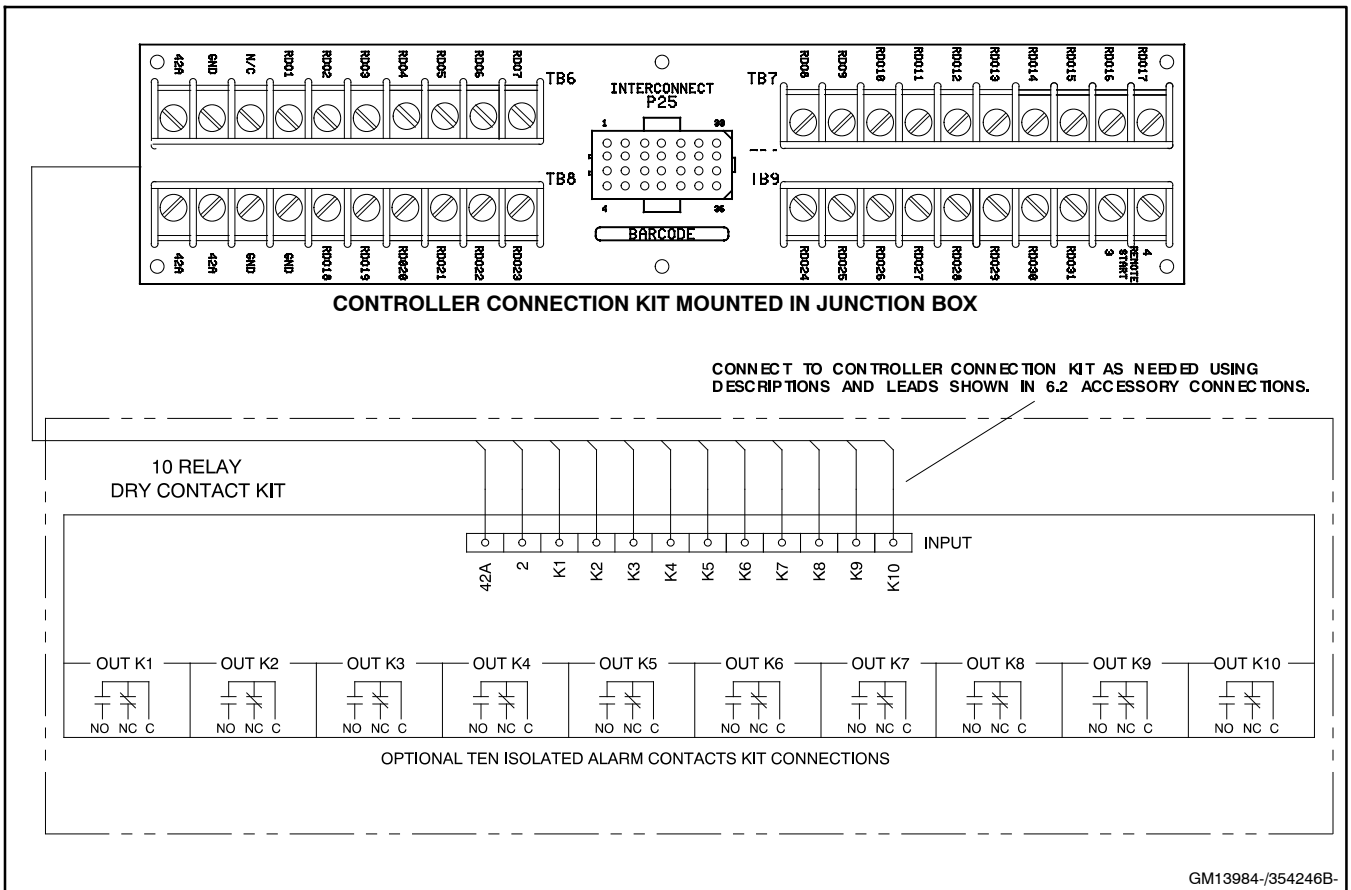

Figure 6-31 Ten-Relay Dry Contact Kit Connections

6.1.18 Twenty-Relay Dry Contact Kit

The twenty-relay dry contact kit provides normally open and normally closed contacts in a form C configuration to activate warning devices and other user-provided accessories allowing remote monitoring of the generator set. Typically, lamps, audible alarms, or other devices signal faults or status conditions. Connect any generator set fault output to the dry contact kit.

Refer to Figure 6-32 for an internal view of the contact kit. See Figure 6-33 for electrical connections. See Section 6.2, Accessory Connections, for terminal identifications.

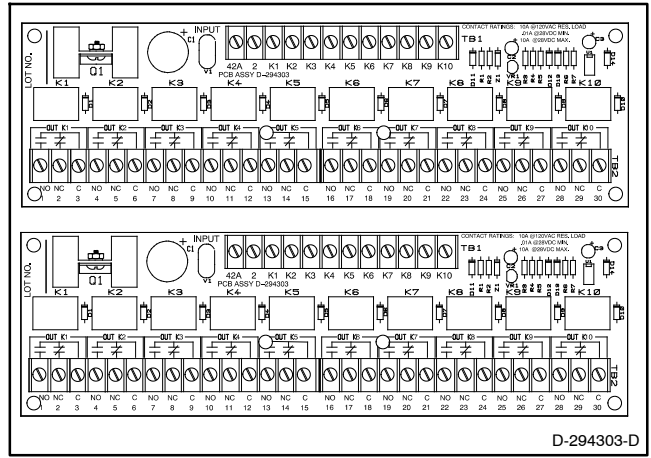

Figure 6-32 Twenty-Relay Dry Contact Kits

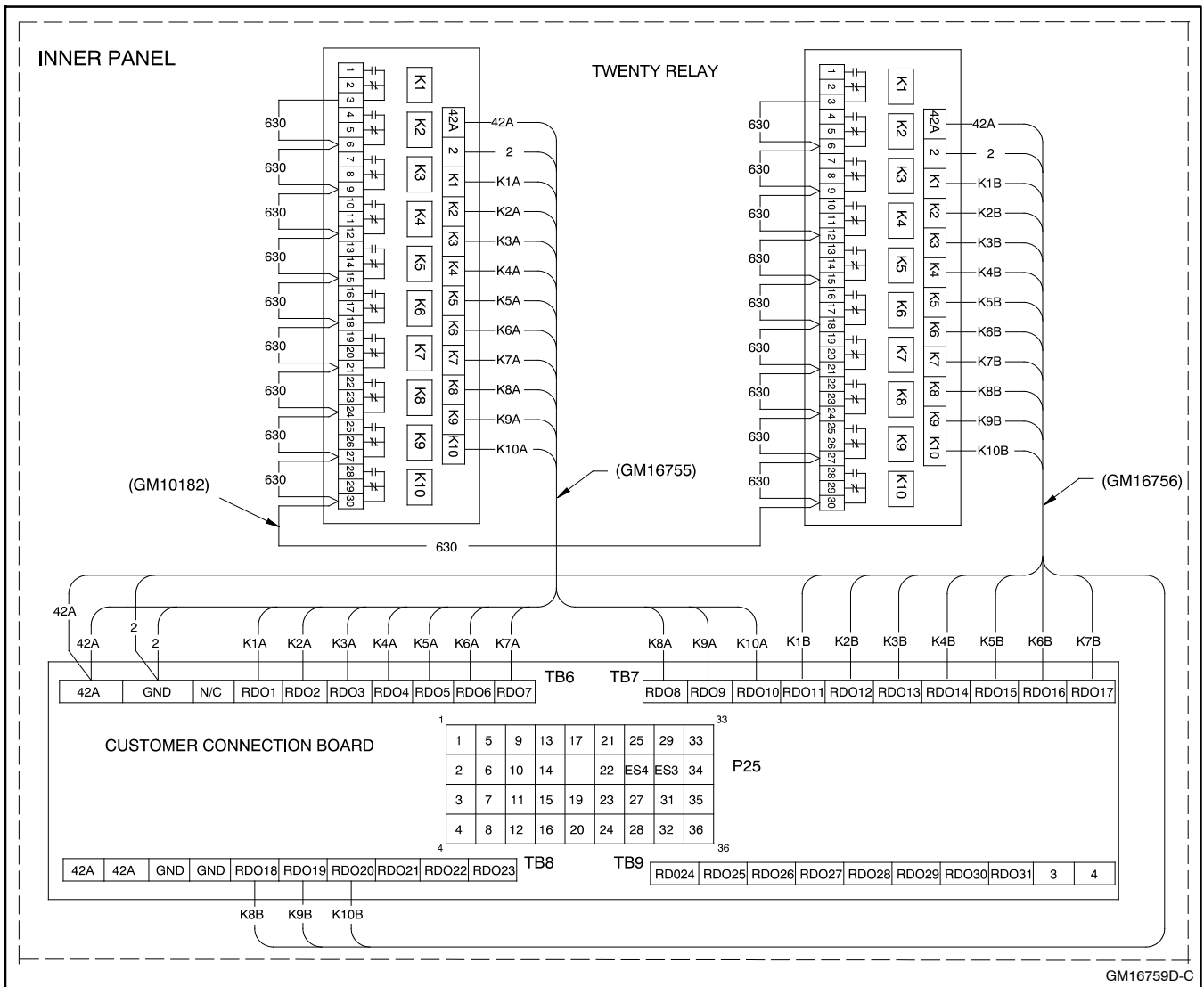

Figure 6-33 Twenty-Relay Dry Contact Relay Kit Connections

6.2 Accessory Connections

The 550 controller contains circuit boards equipped with terminal strip(s) for use in connecting a controller connection kit. Do not connect accessories directly to the controller terminal strip(s). Connect accessories to either a controller connection kit or a dry contact kit. Connect the dry contact kit(s) to the controller connection kit. Connect alarms, battery chargers, remote switches, and other accessories to the dry contact kit relay(s).

For specific information on accessory connections, refer to the accessory wiring diagrams in the wiring diagram manual and the instruction sheet accompanying the kit. See Figure 6-34 and Figure 6-35 for controller interconnection circuit board connections. See Figure 6-36 and Figure 6-37 for controller (customer) connection kit connections. See Figure 6-38, Figure 6-39, and Figure 6-40 for accessory connection wiring diagrams.

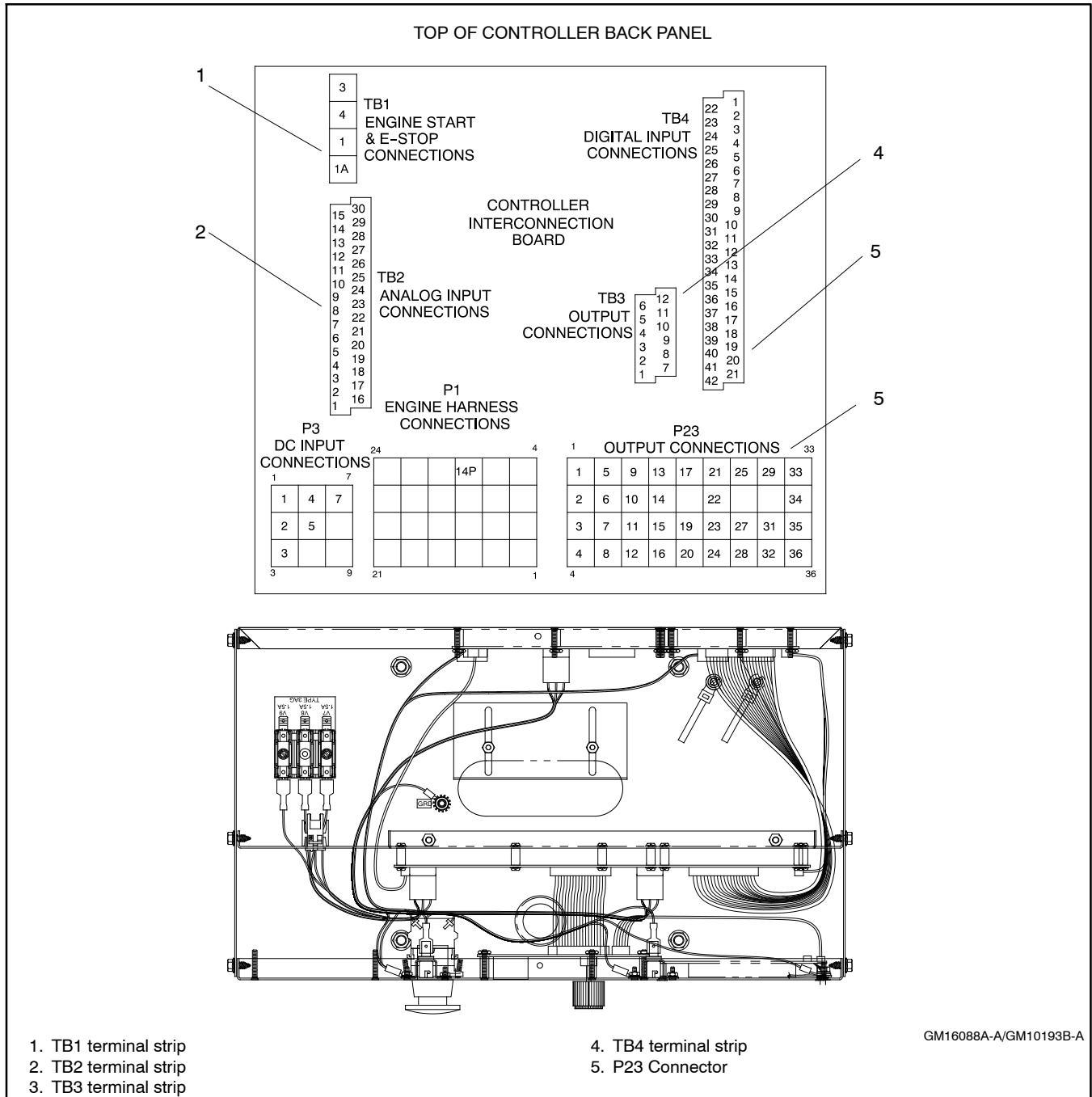

Figure 6-34 Terminal Strips on Controller Interconnection Circuit Board (Controller Back Panel Folded Down)

TB1 Terminal Strip—Engine Start and Emergency Stop Connections

Term. Description

1	Emergency stop ground
1A	Emergency stop
3	Remote start
4	Remote start

TB2 Terminal Strip—Analog Input Connections

Term. Description

1	ACH1 (CTS) Signal (non-ECM including Waukesha)
2	ACH1 (CTS) Supply (non-ECM including Waukesha)
3	ACH2 (OPS) Signal (non-ECM including Waukesha)
4	ACH2 (OPS) Supply (non-ECM including Waukesha)
5	ACH3 Signal (air intake temp. for Waukesha)
6	ACH3 Supply (air intake temp. for Waukesha)
7	ACH4 Signal (oil temp. for Waukesha)
8	ACH4 Supply (oil temp. for Waukesha)
9	ACH5 Signal
10	ACH5 Supply
11	ACH6 Signal
12	ACH6 Supply (VSG for Volvo, GM, Doosan, and KDI)
13	ACH7 Signal (optional analog voltage adjust signal)
14	ACH7 Supply
15	N/C
16	ACH1 (CTS) Return (non-ECM)
17	ACH1 (CTS) Shield ground (non-ECM)
18	ACH2 (OPS or OPS2) Return (non-ECM)
19	ACH2 (OPS) Shield ground (non-ECM)
20	ACH3 (IAT or OPS1) Return
21	ACH3 Shield ground
22	ACH4 (Oil Temp) Return
23	ACH4 Shield ground
24	ACH5 Return
25	ACH5 Shield ground
26	ACH6 Return
27	ACH6 Shield ground
28	ACH7 Return
29	ACH7 Shield ground
30	N/C

TB3 Terminal Strip—Accessory Power Output Connections

Term. Description

1	+12 VDC (OEM use only)
2	+12 VDC (OEM use only)
3	+12 VDC (OEM use only)
4	Fused battery (+) (42A) (5 amp)
5	Fused battery (+) (42A) (5 amp)
6	Fused battery (+) (42A) (5 amp)
7	Battery (-)
8	Battery (-)
9	Battery (-)
10	Battery (-)
11	Battery (-)
12	Panel lamp output

TB4 Terminal Strip—Input Factory Connections

Term. Description

1	DCH1 Battery charger fault
2	DCH2 Low fuel
3	DCH3 Low coolant temp. with ECM models or warning default with non-ECM models
4	DCH4 Field overvoltage with M4/M5/M7 alternators or warning default with non-M4/M5/M7 alternators
5	DCH5 Breaker Closed, Paralleling Applications
6	DCH6 Enable Synch, Paralleling Applications
7	DCH7 Warning
8	DCH8 Warning
9	DCH9 Warning
10	DCH10 Warning
11	DCH11 AFM Shutdown, Waukesha engine
12	DCH12 Detonation Warning, Waukesha engine
13	DCH13 Detonation Shutdown, Waukesha engine
14	DCH14 Warning
15	DCH15 Remote shutdown
16	DCH16 Remote reset
17	DCH17 VAR PF mode
18	DCH18 Voltage lower
19	DCH19 Voltage raise
20	DCH20 Air damper
21	DCH21 Idle mode functional with ECM-equipped engines only
22	DCH1 Return
23	DCH2 Return
24	DCH3 Return
25	DCH4 Return
26	DCH5 Return
27	DCH6 Return
28	DCH7 Return
29	DCH8 Return
30	DCH9 Return
31	DCH10 Return
32	DCH11 Return
33	DCH12 Return
34	DCH13 Return
35	DCH14 Return
36	DCH15 Return
37	DCH16 Return
38	DCH17 Return
39	DCH18 Return
40	DCH19 Return
41	DCH20 Return
42	DCH21 Return

Note: TB4-1 through TB4-21 are user definable with factory defaults listed. Terminals TB4-3, TB4-4, TB4-14, and TB4-21 have different functions depending upon the generator set configuration. See comments above. See Menu 9—Input Setup for changing inputs.

Note: On charger GM87448, the Battery Charger Fault is communicated through CAN communication and the connection on TB4, DCH1, is not used.

Figure 6-35 Controller Terminal Strip Identification

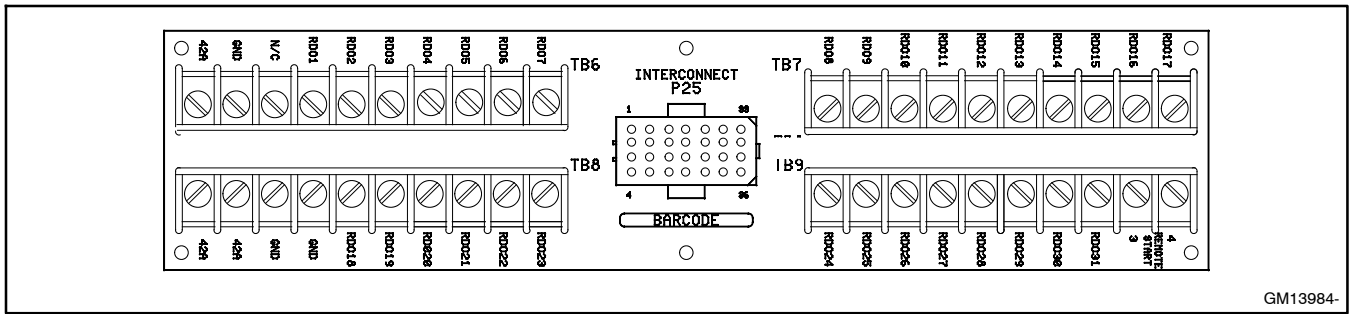

Figure 6-36 Terminal Strips TB6, TB7, TB8, and TB9 on the Controller Connection Kit in the Junction Box

TB6 Terminal Strip—RDOs 1-7		TB9 Terminal Strip—RDOs 24-31	
Term.	Description	Term.	Description
42A	Battery (+)	RDO24	Speed sensor fault
GND	Battery (-)	RDO25	Loss of AC sensing
N/C		RDO26	ECM loss of communication
RDO1	Overspeed (lead 39)	RDO27	Undervoltage
RDO2	Overcrank (lead 12)	RDO28	Overfrequency
RDO3	High coolant temperature shutdown (lead 36)	RDO29	Underfrequency
RDO4	Low oil pressure shutdown (lead 38)	RDO30	Load shed kW overload
RDO5	Low coolant temperature (lead 35)	RDO31	Load shed underfrequency
RDO6	High coolant temperature warning (lead 40)	3	Remote start
RDO7	Low oil pressure warning (lead 41)	4	Remote start
TB7 Terminal Strip—RDOs 8-17		Note: Lead numbers shown in parentheses are the factory default wire designations.	
Term.	Description	Note: RDO-1 though RDO-31 are user definable with the following factory defaults: emergency stop, high coolant temperature, low oil pressure, overcrank, and overspeed	
RDO8	Low fuel (lead 63)	*NFPA-110 common alarm faults include:	
RDO9	Master switch not in auto (lead 80)	Air damper indicator (RDO-23)	
RDO10	NFPA 110 common alarm (lead 32)*	Battery charger fault (RDO-11)	
RDO11	Battery charger fault (lead 61)	EPS supplying load (RDO-22)	
RDO12	Low battery voltage (lead 62)	High battery voltage (RDO-13)	
RDO13	High battery voltage	High coolant temperature warning (RDO-06)	
RDO14	Emergency stop (lead 48)	High coolant temperature shutdown (RDO-03)	
RDO15	Generator set running (lead 70R)	Low battery voltage (RDO-012)	
RDO16	Time delay engine cooldown (TDEC) (lead 70C)	Low coolant level (RDO-19)	
RDO17	System ready (lead 60)	Low coolant temperature warning (RDO-05)	
TB8 Terminal Strip—RDOs 18-23		Low fuel (level or pressure) (RDO-08)	
Term.	Description	Low oil pressure warning (RDO-07)	
42A	Battery (+)	Low oil pressure shutdown (RDO-04)	
42A	Battery (+)	Master switch not in auto (RDO-09)	
GND	Battery (-)	Overcrank (RDO-02)	
GND	Battery (-)	Overspeed (RDO-01)	
RDO18	Defined common fault (lead 32A)		
RDO19	Low coolant level		
RDO20	Overvoltage (lead 26)		
RDO21	Idle mode		
RDO22	EPS supplying load		
RDO23	Air damper indicator (lead 56)		

Figure 6-37 Controller (Customer) Connection Kit Terminal Strip Identification with Relay Driver Outputs (RDOs)

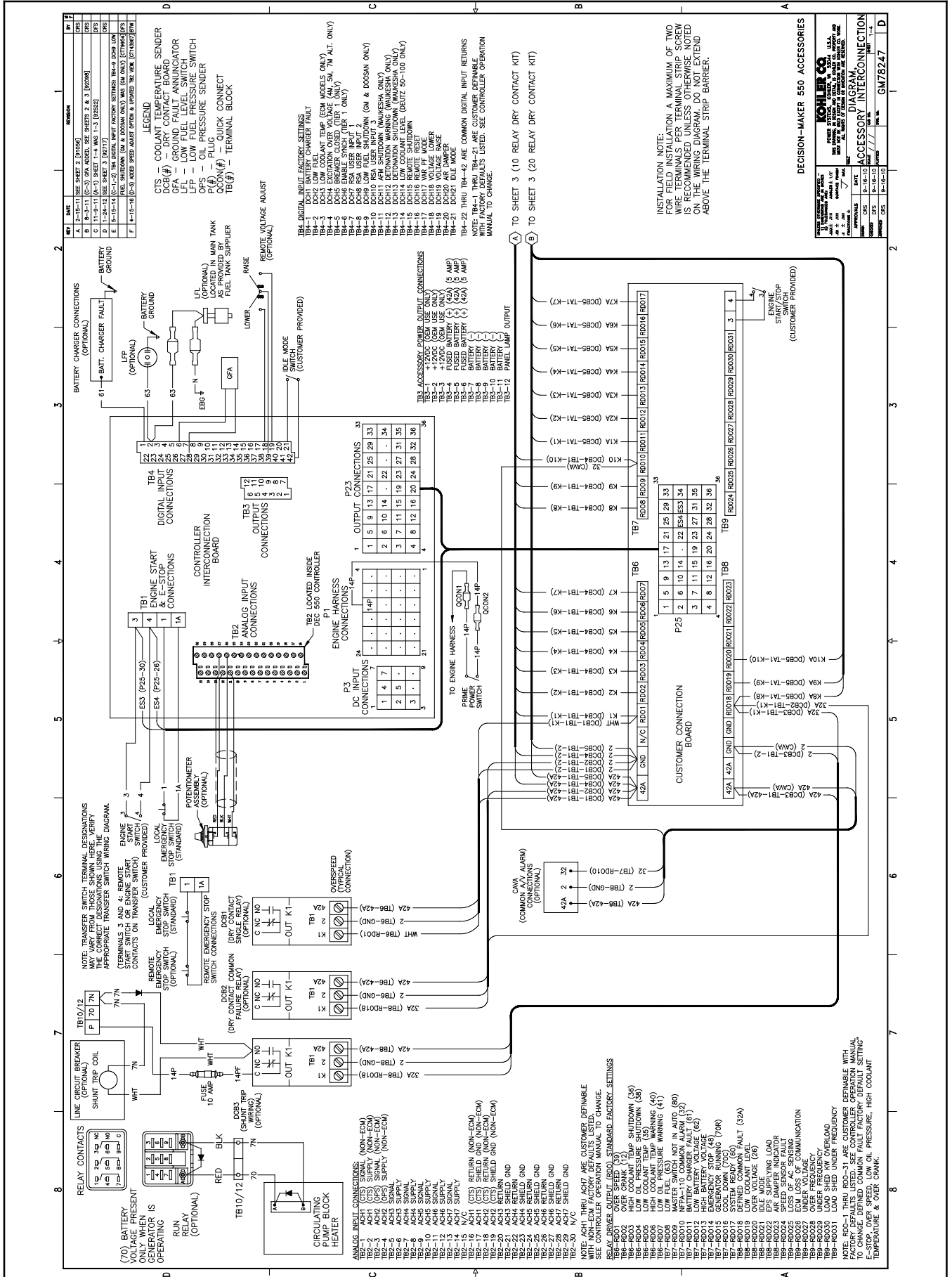
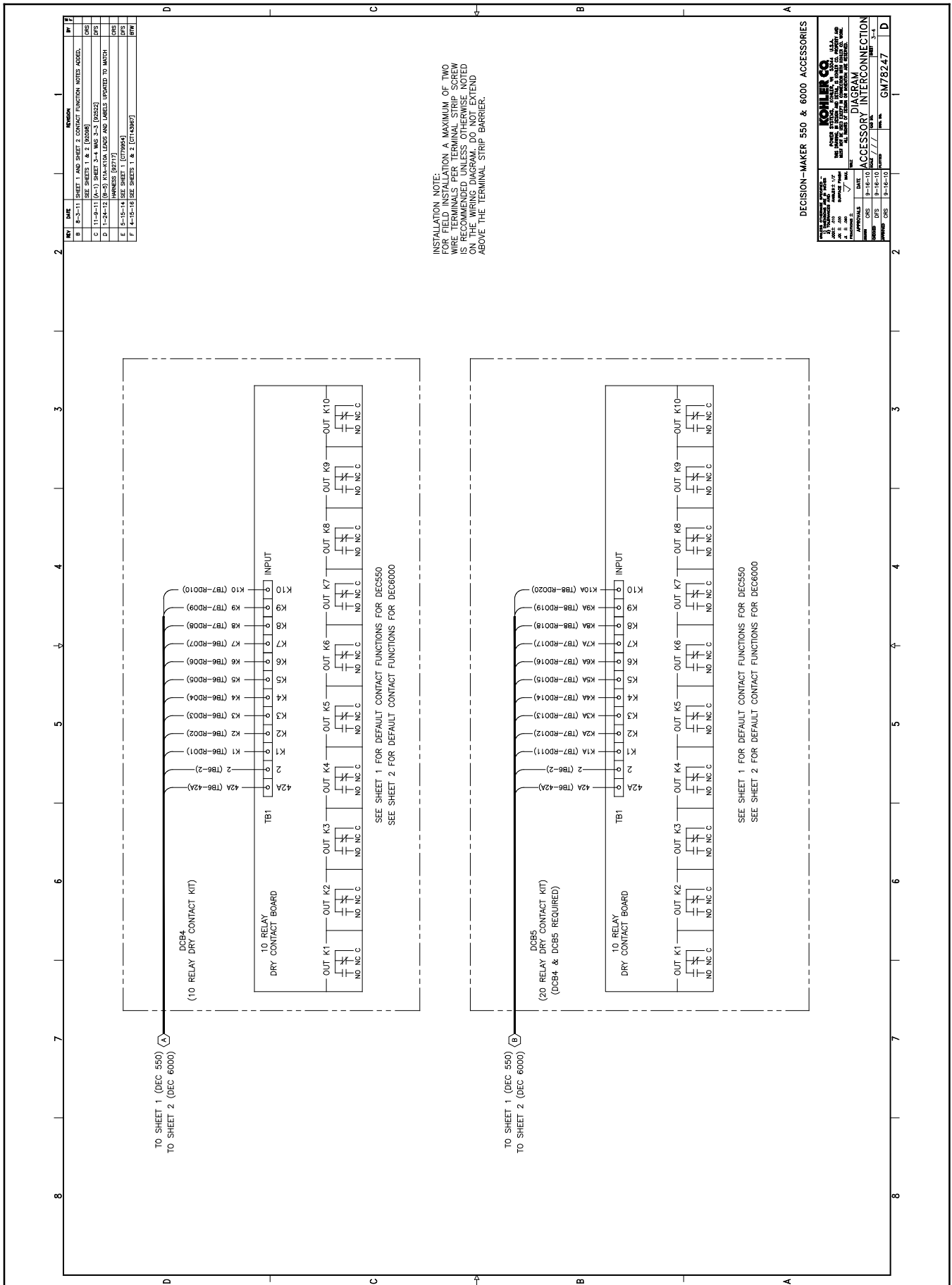

Figure 6-38 Accessory Connections GM78247F-1



REV	DATE	REVISION
B	8-3-11	SHEET 1 AND SHEET 2 CONTACT FUNCTION NOTES ADDED.
A	1-2-11	SEE SHEETS 1 & 2 (DEC6000)
5	1-2-11	TERMINAL MARKING CHANGED TO (TB6-42)
4	1-2-11	TERMINAL MARKING CHANGED TO (TB6-42)
3	1-2-11	TERMINAL MARKING CHANGED TO (TB6-42)
2	1-2-11	TERMINAL MARKING CHANGED TO (TB6-42)
1	1-2-11	TERMINAL MARKING CHANGED TO (TB6-42)
		MARKING (B717)
		MARKING (C77094)
		MARKING (D711097)

APPROVALS		DATE
DESIGNED	DES	8-15-10
CHECKED	DES	8-15-10
APPROVED	DES	8-15-10

KOHLER CO.	
11000 W. 110th Street, Omaha, NE 68148	TEL: 402.426.1000
11000 W. 110th Street, Omaha, NE 68148	FAX: 402.426.1001
11000 W. 110th Street, Omaha, NE 68148	WWW.KOHLER.COM

DIAGRAM	
PROJECT	GM78247
DATE	8-15-10
REV	1
BY	DES
CHECKED	DES
APPROVED	DES

Figure 6-39 Accessory Connections GM78247F-3

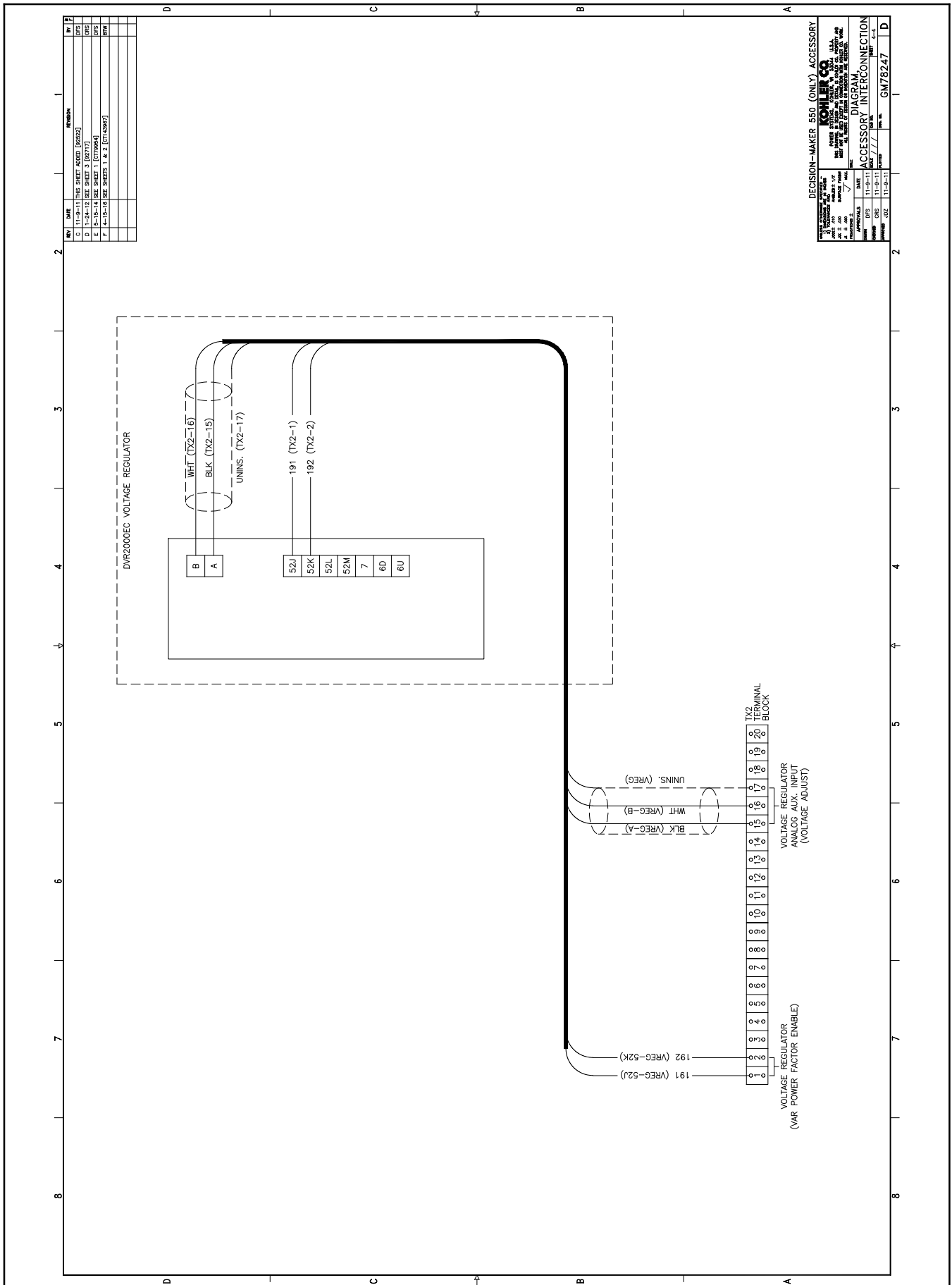

Figure 6-40 Accessory Connections GM78247F-4

Appendix A Abbreviations

The following list contains abbreviations that may appear in this publication.

A, amp	ampere	cfm	cubic feet per minute	exh.	exhaust
ABDC	after bottom dead center	CG	center of gravity	ext.	external
AC	alternating current	CID	cubic inch displacement	F	Fahrenheit, female
A/D	analog to digital	CL	centerline	FHM	flat head machine (screw)
ADC	advanced digital control; analog to digital converter	cm	centimeter	fl. oz.	fluid ounce
adj.	adjust, adjustment	CMOS	complementary metal oxide substrate (semiconductor)	flex.	flexible
ADV	advertising dimensional drawing	com	communications (port)	freq.	frequency
Ah	amp-hour	coml	commercial	FS	full scale
AHWT	anticipatory high water temperature	Coml/Rec	Commercial/Recreational connection	ft.	foot, feet
AISI	American Iron and Steel Institute	conn.	connection	ft. lb.	foot pounds (torque)
ALOP	anticipatory low oil pressure	cont.	continued	ft./min.	feet per minute
alt.	alternator	CPVC	chlorinated polyvinyl chloride	ftp	file transfer protocol
Al	aluminum	crit.	critical	g	gram
ANSI	American National Standards Institute (formerly American Standards Association, ASA)	CSA	Canadian Standards Association	ga.	gauge (meters, wire size)
AO	anticipatory only	CT	current transformer	gal.	gallon
APDC	Air Pollution Control District	Cu	copper	gen.	generator
API	American Petroleum Institute	cUL	Canadian Underwriter's Laboratories	genset	generator set
approx.	approximate, approximately	CUL	Canadian Underwriter's Laboratories	GFI	ground fault interrupter
APU	Auxiliary Power Unit	cu. in.	cubic inch	GND, ⊕	ground
AQMD	Air Quality Management District	cw.	clockwise	gov.	governor
AR	as required, as requested	CWC	city water-cooled	gph	gallons per hour
AS	as supplied, as stated, as suggested	cyl.	cylinder	gpm	gallons per minute
ASE	American Society of Engineers	D/A	digital to analog	gr.	grade, gross
ASME	American Society of Mechanical Engineers	DAC	digital to analog converter	GRD	equipment ground
assy.	assembly	dB	decibel	gr. wt.	gross weight
ASTM	American Society for Testing Materials	dB(A)	decibel (A weighted)	H x W x D	height by width by depth
ATDC	after top dead center	DC	direct current	HC	hex cap
ATS	automatic transfer switch	DCR	direct current resistance	HCHT	high cylinder head temperature
auto.	automatic	deg., °	degree	HD	heavy duty
aux.	auxiliary	dept.	department	HET	high exhaust temp., high engine temp.
avg.	average	dia.	diameter	hex	hexagon
AVR	automatic voltage regulator	DI/EO	dual inlet/end outlet	Hg	mercury (element)
AWG	American Wire Gauge	DIN	Deutsches Institut fur Normung e. V. (also Deutsche Industrie Normenausschuss)	HH	hex head
AWM	appliance wiring material	DIP	dual inline package	HHC	hex head cap
bat.	battery	DPDT	double-pole, double-throw	HP	horsepower
BBDC	before bottom dead center	DPST	double-pole, single-throw	hr.	hour
BC	battery charger, battery charging	DS	disconnect switch	HS	heat shrink
BCA	battery charging alternator	DVR	digital voltage regulator	hsg.	housing
BCI	Battery Council International	E ² PROM, EEPROM	electrically-erasable programmable read-only memory	HVAC	heating, ventilation, and air conditioning
BDC	before dead center	E, emer.	emergency (power source)	HWT	high water temperature
BHP	brake horsepower	ECM	electronic control module, engine control module	Hz	hertz (cycles per second)
blk.	black (paint color), block (engine)	EDI	electronic data interchange	IBC	International Building Code
blk. htr.	block heater	EFR	emergency frequency relay	IC	integrated circuit
BMEP	brake mean effective pressure	e.g.	for example (<i>exempli gratia</i>)	ID	inside diameter, identification
bps	bits per second	EG	electronic governor	IEC	International Electrotechnical Commission
br.	brass	EGSA	Electrical Generating Systems Association	IEEE	Institute of Electrical and Electronics Engineers
BTDC	before top dead center	EIA	Electronic Industries Association	IMS	improved motor starting
Btu	British thermal unit	EI/EO	end inlet/end outlet	in.	inch
Btu/min.	British thermal units per minute	EMI	electromagnetic interference	in. H ₂ O	inches of water
C	Celsius, centigrade	emiss.	emission	in. Hg	inches of mercury
cal.	calorie	eng.	engine	in. lb.	inch pounds
CAN	controller area network	EPA	Environmental Protection Agency	Inc.	incorporated
CARB	California Air Resources Board	EPS	emergency power system	ind.	industrial
CAT5	Category 5 (network cable)	ER	emergency relay	int.	internal
CB	circuit breaker	ES	engineering special, engineered special	int./ext.	internal/external
CC	crank cycle	ESD	electrostatic discharge	I/O	input/output
cc	cubic centimeter	est.	estimated	IP	internet protocol
CCA	cold cranking amps	E-Stop	emergency stop	ISO	International Organization for Standardization
ccw.	counterclockwise	etc.	et cetera (and so forth)	J	joule
CEC	Canadian Electrical Code			JIS	Japanese Industry Standard
cert.	certificate, certification, certified			k	kilo (1000)
cfh	cubic feet per hour			K	kelvin
				kA	kiloampere
				KB	kilobyte (2 ¹⁰ bytes)
				KBus	Kohler communication protocol
				kg	kilogram

kg/cm ²	kilograms per square centimeter	NBS	National Bureau of Standards	RTU	remote terminal unit
kgm	kilogram-meter	NC	normally closed	RTV	room temperature vulcanization
kg/m ³	kilograms per cubic meter	NEC	National Electrical Code	RW	read/write
kHz	kilohertz	NEMA	National Electrical Manufacturers Association	SAE	Society of Automotive Engineers
kJ	kilojoule	NFPA	National Fire Protection Association	scfm	standard cubic feet per minute
km	kilometer	Nm	newton meter	SCR	silicon controlled rectifier
kOhm, kΩ	kilo-ohm	NO	normally open	s, sec.	second
kPa	kilopascal	no., nos.	number, numbers	SI	<i>Systeme international d'unites</i> , International System of Units
kph	kilometers per hour	NPS	National Pipe, Straight	SI/EO	side in/end out
kV	kilovolt	NPSC	National Pipe, Straight-coupling	sil.	silencer
kVA	kilovolt ampere	NPT	National Standard taper pipe thread per general use	SMTP	simple mail transfer protocol
kVAR	kilovolt ampere reactive	NPTF	National Pipe, Taper-Fine	SN	serial number
kW	kilowatt	NR	not required, normal relay	SNMP	simple network management protocol
kWh	kilowatt-hour	ns	nanosecond	SPDT	single-pole, double-throw
kWm	kilowatt mechanical	OC	overcrank	SPST	single-pole, single-throw
kWth	kilowatt-thermal	OD	outside diameter	spec	specification
L	liter	OEM	original equipment manufacturer	specs	specification(s)
LAN	local area network	OF	overfrequency	sq.	square
L x W x H	length by width by height	opt.	option, optional	sq. cm	square centimeter
lb.	pound, pounds	OS	oversize, overspeed	sq. in.	square inch
lbm/ft ³	pounds mass per cubic feet	OSHA	Occupational Safety and Health Administration	SMS	short message service
LCB	line circuit breaker	OV	overvoltage	SS	stainless steel
LCD	liquid crystal display	oz.	ounce	std.	standard
LED	light emitting diode	p., pp.	page, pages	stl.	steel
Lph	liters per hour	PC	personal computer	tach.	tachometer
Lpm	liters per minute	PCB	printed circuit board	TB	terminal block
LOP	low oil pressure	pF	picofarad	TCP	transmission control protocol
LP	liquefied petroleum	PF	power factor	TD	time delay
LPG	liquefied petroleum gas	ph., ∅	phase	TDC	top dead center
LS	left side	PHC	Phillips® head Crimptite® (screw)	TDEC	time delay engine cooldown
L _{wa}	sound power level, A weighted	PHH	Phillips® hex head (screw)	TDEN	time delay emergency to normal
LWL	low water level	PHM	pan head machine (screw)	TDES	time delay engine start
LWT	low water temperature	PLC	programmable logic control	TDNE	time delay normal to emergency
m	meter, milli (1/1000)	PLC	programmable logic control	TDOE	time delay off to emergency
M	mega (10 ⁶ when used with SI units), male	PMG	permanent magnet generator	TDON	time delay off to normal
m ³	cubic meter	pot	potentiometer, potential	temp.	temperature
m ³ /hr.	cubic meters per hour	ppm	parts per million	term.	terminal
m ³ /min.	cubic meters per minute	PROM	programmable read-only memory	THD	total harmonic distortion
mA	milliampere	psi	pounds per square inch	TIF	telephone influence factor
man.	manual	psig	pounds per square inch gauge	tol.	tolerance
max.	maximum	pt.	pint	turbo.	turbocharger
MB	megabyte (2 ²⁰ bytes)	PTC	positive temperature coefficient	typ.	typical (same in multiple locations)
MCCB	molded-case circuit breaker	PTO	power takeoff	UF	underfrequency
MCM	one thousand circular mils	PVC	polyvinyl chloride	UHF	ultrahigh frequency
meggarr	megohmmeter	qt.	quart, quarts	UIF	user interface
MHz	megahertz	qty.	quantity	UL	Underwriter's Laboratories, Inc.
mi.	mile	R	replacement (emergency) power source	UNC	unified coarse thread (was NC)
mil	one one-thousandth of an inch	rad.	radiator, radius	UNF	unified fine thread (was NF)
min.	minimum, minute	RAM	random access memory	univ.	universal
misc.	miscellaneous	RDO	relay driver output	URL	uniform resource locator (web address)
MJ	megajoule	ref.	reference	US	undersize, underspeed
mJ	millijoule	rem.	remote	UV	ultraviolet, undervoltage
mm	millimeter	Res/Coml	Residential/Commercial	V	volt
mOhm, mΩ	milliohm	RFI	radio frequency interference	VAC	volts alternating current
MOhm, MΩ	megohm	RH	round head	VAR	voltampere reactive
MOV	metal oxide varistor	RHM	round head machine (screw)	VDC	volts direct current
MPa	megapascal	rly.	relay	VFD	vacuum fluorescent display
mpg	miles per gallon	rms	root mean square	VGA	video graphics adapter
mph	miles per hour	rnd.	round	VHF	very high frequency
MS	military standard	RO	read only	W	watt
ms	millisecond	ROM	read only memory	WCR	withstand and closing rating
m/sec.	meters per second	rot.	rotate, rotating	w/	with
mtg.	mounting	rpm	revolutions per minute	WO	write only
MTU	Motoren-und Turbinen-Union	RS	right side	w/o	without
MW	megawatt	RTDs	Resistance Temperature Detectors	wt.	weight
mW	milliwatt			xfrm	transformer
μF	microfarad				
N, norm.	normal (power source)				
NA	not available, not applicable				
nat. gas	natural gas				

Appendix B User-Defined Settings

Use the table below to record user-defined settings during the generator set controller setup and calibration. The controller default settings and ranges provide guidelines. The table contains all faults with ranges and time delays including items that do not have adjustments. Not adjustable user-defined settings result when the controller logic does not allow changes or the values are engine limited.

Note: Inhibit time delay is the time delay period after crank disconnect.

Note: The engine ECM may limit the crank cycle even if the controller is set to a longer time period.

User-Defined Settings

Status Event or Fault	Refer to Menu	Digital Display	Relay Driver Output (RDO)	Range Setting	Default Selection	Inhibit Time Delay (sec.)	Time Delay (sec.)	User-Defined Settings
Access Code (password)	14			User-Selectable	0 (zero)			
AC Sensing Loss	10	AC SENSING LOSS	RDO-25 *					Not adjustable
Air Damper Control (if used) **	10							Not adjustable
Air Damper Indicator (if used), see D20 **								—
Air/Fuel Module (AFM) Engine Start Delay ‡	10	AFM ENG START DELAY		Fixed				Not adjustable
Air/Fuel Module (AFM) Remote Start ‡	10	AFM REMOTE START	RDO-25 ‡					Not adjustable
Air/Fuel Module (AFM) Shutdown (see D11) ‡								Not adjustable
Alternator Protection Shutdown	10	ALTERNATOR PROTECTION						Not adjustable
Analog Aux. Input 0	9	LOCAL BATT VDC		Fixed				Not adjustable
Analog Aux. Inputs A01-A07	9	USER-DEFINED A01-A07		Default Values with Warning Enabled: HI warning 90% LO warning 10% HI shutdown 100% LO shutdown 1%	30 sec. inhibit, 5 sec. delay	0-60	0-60	
Analog Aux. Input A01 (non-ECM only)	9	A01 COOLANT TEMP		Default Values with Warning Enabled: HI/LO warning and HI/LO shutdown are all engine dependent	30 sec. inhibit, 0 sec. delay warning, 5 sec. delay shutdown			Not adjustable
Analog Aux. Input A02 (non-ECM only)	9	A02 OIL PRESSURE		Default Values with Warning Enabled: HI/LO warning and HI/LO shutdown are all engine dependent (255 psi max.)	30 sec. inhibit, 0 sec. delay warning, 5 sec. delay shutdown			Not adjustable
Analog Aux. Input A03 ‡	9	A03 INTAKE AIR TEMP		Default Values with Warning Enabled: HI/LO warning are all engine dependent	30 sec. inhibit, 0 sec. delay warning			Not adjustable
Analog Aux. Input A04 *	9	A04 FUEL LEVEL		Default Values with Warning Enabled: HI/LO warning are engine dependent	30 sec. inhibit, 0 sec. delay warning			

* All models, except Waukesha-powered models.

† Non-paralleling applications

‡ Waukesha-powered models

§ Paralleling applications

|| Denotes the default parameter range. Typically, ranges for the NiCad battery topology are slightly wider. For more details, refer to the battery charger operation manual.

** NFPA applications

†† DDC/MTU engine with MDEC/ADEC

‡‡ FAA only

Status Event or Fault	Refer to Menu	Digital Display	Relay Driver Output (RDO)	Range Setting	Default Selection	Inhibit Time Delay (sec.)	Time Delay (sec.)	User-Defined Settings
Analog Aux. Input A04 ‡	9	A04 OIL TEMP		Default Values with Warning Enabled: HI/LO warning are engine dependent	30 sec. inhibit, 0 sec. delay warning			Not adjustable
Analog Aux. Input A06 VSG (Volvo, GM, Doosan, and KDI only)	9, 12	A06 ANALOG AUXILIARY IN						Analog VSG 06 for Speed Adjust in Menu 7
Analog Aux. Input A07	9, 11	A07 ANALOG VOLT ADJUST		±10% of system voltage over the range of 0.5-4.5 VDC				
Battery Charger Communication Error		CHRG COMM ERROR						—
Battery Charger Fault (see D01) ** Note: On charger GM87448, Battery Charger Fault is communicated through CAN communication and D01 is not used.		BATTERY CHRGR FAULT						—
Battery Charger Value Mismatch Error		CHGR VAL ERROR						—
Battle Switch (Fault Shutdown Override Switch)	9	BATTLE SWITCH		Fixed				Not adjustable
Block Heater Control ††	10	BLOCK HEATER CONTROL	RDO only					
Breaker Trip §	10	BREAKER TRIP	RDO-30					Not adjustable
Charger Absorption Current Termination Target (A)	18	ABSORPTION TERMINATION		1 – 5	2			
Charger Automatic Equalize Enable Note: Equalize is only available with FLA/VRLA topology selected.	18	AUTOMATIC EQUALIZE ENABLED		Active Inactive	Inactive			
Charger Charge Cycles Between Auto Equalize Cycles Note: Equalize is only available with FLA/VRLA topology selected.	18			0 – 99				Adjustable with Charger Custom Profile enabled.
Charger Custom Profile Enable	18	CUSTOM CHARGING PROFILE ENABLE		Active Inactive	Inactive			
Charger Depleted Battery Current Limit	18			1 – 5	2			
Charger Depleted Battery Voltage Target	18			4 – 12 (12 V) 18 – 24 (24 V)	10 (12 V) 20 (24 V)			Adjustable with Charger Custom Profile enabled.
* All models, except Waukesha-powered models. † Non-paralleling applications ‡ Waukesha-powered models § Paralleling applications Denotes the default parameter range. Typically, ranges for the NiCad battery topology are slightly wider. For more details, refer to the battery charger operation manual.				** NFPA applications †† DDC/MTU engine with MDEC/ADEC ‡‡ FAA only				

Status Event or Fault	Refer to Menu	Digital Display	Relay Driver Output (RDO)	Range Setting	Default Selection	Inhibit Time Delay (sec.)	Time Delay (sec.)	User-Defined Settings
Charger Temperature Compensation Slope (mV/°C)	18	TEMPERATURE COMP SLOPE		-40 – 0 (12 V) -80 – 0 (24 V)	-30 (12 V) -60 (24 V)			Adjustable with Charger Custom Profile enabled.
Charger Voltage Absorption (V)	18	ABSORPTION VOLTAGE		13 – 15 (12 V)¶ 26 – 30 (24 V)¶	14.25 (12 V) 28.5 (24 V)			Adjustable with Charger Custom Profile enabled.
Charger Voltage Bulk (V)	18	BULK VOLTAGE		13 – 15 (12 V)¶ 26 – 30 (24 V)¶	14.25 (12 V) 28.5 (24 V)			Adjustable with Charger Custom Profile enabled.
Charger Voltage Equalize (V) Note: Equalize is only available with FLA/VRLA topology selected.	18	EQUALIZE VOLTAGE		14 – 16 (12 V) 28 – 32 (24 V)				Adjustable with Charger Custom Profile enabled.
Charger Voltage Float (V)	18	FLOAT VOLTAGE		13 – 14 (12 V)¶ 26 – 28 (24 V)¶	13.25 (12 V) 26.5 (24 V)			Adjustable with Charger Custom Profile enabled.
Common Protective Relay Output §	10	COMMON PROTECTIVE RELAY OUTPUT	RDO-31 §					Not adjustable
Critical Overvoltage Shutdown	10	CRITICAL OVERVOLTAGE		Fixed	275 volts (L1-L2)			Not adjustable
Cyclic Cranking	8			1–6 crank cycles 10–30 sec. crank on 1–60 sec. pause	3 15 sec. 15 sec.			
Defined Common Faults (each input value is set separately)	10	DEFINED COMMON FAULT	RDO-18 (lead 32A)	Default shutdowns include: Emergency stop High coolant temp Low oil pressure Overcrank Overspeed	30 sec. inhibit, 5 sec. delay	0–60	0–60	
Detonation Shutdown (see D13) ‡								—
Detonation Warning (see D12) ‡								—
Digital Aux. Input D01–D21	9, 10	USER-DEFINED D01–D21			30 sec. inhibit, 5 sec. delay	0–60	0–60	
Digital Aux. Input D01 Battery Charger Fault **	9, 10	D01 BATTERY CHARGER FAULT	RDO-11 (lead 61)	Fixed	0 sec. inhibit, 0 sec. delay			Not adjustable
Digital Aux. Input D02 Low Fuel Warning **	9, 10	D02 LOW FUEL WARNING	RDO-08 (lead 63)	Fixed	0 sec. inhibit, 0 sec. delay			Not adjustable
Digital Aux. Input D03 Low Coolant Temperature **	9, 10	D03 LOW COOLANT TEMP	RDO-05 (lead 35)	Fixed	0 sec. inhibit, 0 sec. delay			Not adjustable
Digital Aux. Input D04 Field Overvoltage (M4, M5, or M7 alternator only)	9, 10	D04 FIELD OVERVOLTAGE		Fixed	1 sec. inhibit, 15 sec. delay			Not adjustable

* All models, except Waukesha-powered models. ** NFPA applications
† Non-paralleling applications †† DDC/MTU engine with MDEC/ADEC
‡ Waukesha-powered models ‡‡ FAA only
§ Paralleling applications
¶ Denotes the default parameter range. Typically, ranges for the NiCad battery topology are slightly wider. For more details, refer to the battery charger operation manual.

Status Event or Fault	Refer to Menu	Digital Display	Relay Driver Output (RDO)	Range Setting	Default Selection	Inhibit Time Delay (sec.)	Time Delay (sec.)	User-Defined Settings
Digital Aux. Input D05 Breaker Closed §	9, 10	D05 BREAKER CLOSED		Fixed	0 sec. inhibit, 0 sec. delay			Not adjustable
Digital Aux. Input D06 §	9, 10	D06 ENABLE SYNCH			20 sec. inhibit, 0 sec. delay			Not adjustable
Digital Aux. Input D09 Low Fuel Pressure Shutdown (125RZG only)	9, 10	D09 LOW FUEL SHUTDOWN		Fixed	5 sec. inhibit, 0 sec. delay			Not adjustable
Digital Aux. Input D11 Air/Fuel Module (AFM) Shutdown ‡	9, 10	D11 AFM SHUTDOWN		Fixed	0 sec. inhibit, 0 sec. delay			Not adjustable
Digital Aux. Input D12 Detonation Warning ‡	9, 10	D12 DETON WARNING		Fixed	2 sec. inhibit, 0 sec. delay			Not adjustable
Digital Aux. Input D13 Detonation Sensing Module (DSM) Shutdown ‡	9, 10	D13 DETON SHUTDOWN		Fixed	0 sec. inhibit, 0 sec. delay			Not adjustable
Digital Aux. Input D13 Knock Detection Module (KDM) Shutdown ‡	9, 10	D13 KNOCK SHUTDOWN		Fixed	0 sec. inhibit, 0 sec. delay			Not adjustable
Digital Aux. Input D14 Low Coolant Level, (with LCL switch) **	9, 10	D14 LOW COOLANT LVL	RDO-19	Fixed	30 sec. inhibit, 5 sec. delay			Not adjustable
Digital Aux. Input D15 Remote Shutdown	9, 10	D15 REMOTE SHUTDOWN			0 sec. inhibit, 0 sec. delay			Not adjustable
Digital Aux. Input D16 Remote Reset	9, 10							Not adjustable
Digital Aux. Input D17 VAR/PF mode	9, 10							Not adjustable
Digital Aux. Input D18 Voltage Lower	9, 10							Not adjustable
Digital Aux. Input D19 Voltage Raise	9, 10							Not adjustable
Digital Aux. Input D20 Air Damper Indicator (if used) **	9, 10	D20 AIR DAMPER	RDO-23 * (lead 56)	Fixed	0 sec. inhibit, 0 sec. delay			Not adjustable
Digital Aux. Input D21 Idle (speed) Mode Function	9, 10	D21 IDLE MODE ACTIVE	RDO-21	Fixed inhibit time	0 sec. inhibit, 60 sec. delay		0-600 or 9:99 for infinity	Not adjustable
ECM Red Alarm (was MDEC Yellow Alarm) ††	10	ECM RED ALARM						Not adjustable
ECM Yellow Alarm (was MDEC Yellow Alarm) ††	10	ECM YELLOW ALARM						Not adjustable
EEPROM Write Failure	10	EEPROM WRITE FAILURE						Not adjustable
Emergency Stop Shutdown	10	EMERGENCY STOP	RDO-14 (lead 48)					Not adjustable
Engine Cooldown (see Time Delay-)								—

* All models, except Waukesha-powered models.

† Non-paralleling applications

‡ Waukesha-powered models

§ Paralleling applications

|| Denotes the default parameter range. Typically, ranges for the NiCad battery topology are slightly wider. For more details, refer to the battery charger operation manual.

** NFPA applications

†† DDC/MTU engine with MDEC/ADEC

‡‡ FAA only

Status Event or Fault	Refer to Menu	Digital Display	Relay Driver Output (RDO)	Range Setting	Default Selection	Inhibit Time Delay (sec.)	Time Delay (sec.)	User-Defined Settings
Engine Derate Active	10	ENGINE DERATE ACTIVE						Not adjustable
(Engine) J1939 CAN Engine Shutdown	10	J1939 CAN SHUTDOWN						Not adjustable
Engine Stalled	10	ENGINE STALLED						Not adjustable
Engine Start (see Time Delay-)								—
EPS (Emergency Power System) Supplying Load	10	EPS SUPPLYING LOAD	RDO-22	Fixed	1% of rated line current			Not adjustable
Equalize Current Limit (A) Note: Equalize is only available with FLA/VRLA topology selected.	18			1–5				Adjustable with Charger Custom Profile enabled.
Field Overvoltage (see D04)								Not adjustable
Forced Charge Cycle Reset	18			Active Inactive	Inactive			
Fuel Level (see A04)								—
Fuel Valve Relay ‡	10	FUEL VALVE RELAY	RDO-23 ‡					Not adjustable
Generator Set Running	10		RDO-15 (lead 70R)					Not adjustable
Ground Fault Detected	10	GROUND FAULT						Not adjustable
High Battery Voltage	10	HIGH BATTERY VOLTAGE	RDO-13	14.5–16.5 V (12 V) 29–33 V (24 V)	16 V (12 V) 32 V (24 V)		10	
High Coolant Temperature Shutdown	10	HI COOL TEMP SHUTDOWN	RDO-03 (lead 36)			30	5	Not adjustable
High Coolant Temperature Warning	10	HI COOL TEMP WARNING	RDO-06 (lead 40)			30		Not adjustable
High Oil Temperature Shutdown	10	HI OIL TEMP SHUTDOWN				30	5	Not adjustable
High Oil Temperature Warning ‡ ††	10	HI OIL TEMP WARNING				30		Not adjustable
Idle (speed) Mode Function (see D21)								—
In Synch §	10	IN SYNCH	RDO-29 *					Not adjustable
Intake Air Temperature Shutdown ††	10	INTAKE AIR TEMP SDWN				30		Not adjustable
Intake Air Temp. Warning ††	10	INTAKE AIR TEMP WARN				30		Not adjustable
Intake Air Temp. Warning (see A03) ‡								—
Intake Air Temp. Shutdown (see A03)‡								—
Internal Fault Shutdown	10	INTERNAL FAULT						Not adjustable

* All models, except Waukesha-powered models.

† Non-paralleling applications

‡ Waukesha-powered models

§ Paralleling applications

|| Denotes the default parameter range. Typically, ranges for the NiCad battery topology are slightly wider. For more details, refer to the battery charger operation manual.

** NFPA applications

†† DDC/MTU engine with MDEC/ADEC

‡‡ FAA only

Status Event or Fault	Refer to Menu	Digital Display	Relay Driver Output (RDO)	Range Setting	Default Selection	Inhibit Time Delay (sec.)	Time Delay (sec.)	User-Defined Settings
J1939 CAN Shutdown (see Engine J1939 CAN Shutdown)								—
Knock Shutdown (see D13) ‡								—
kW Overload (see Load Shed)								—
Load Shed kW Overload ‡‡	10	LOAD SHED KW OVER	RDO-30 ‡‡	80%–120%	100% of kW rating with 5 sec. delay		2–10	
Load Shed Over Temperature †† (Activated by a High Coolant Temp. shutdown)	10	LOAD SHED OVER TEMPERATURE	RDO only					Not adjustable
Load Shed Underfrequency †	10	LOAD SHED UNDER FREQUENCY	RDO-31 †		59 Hz (60 Hz) 49 Hz (50 Hz)		5	Not adjustable
Locked Rotor Shutdown	10	LOCKED ROTOR						Not adjustable
Loss of ECM Communication (ECM only)	10	LOSS OF ECM COMM	RDO-26 *				4	Not adjustable
Loss of Field Shutdown §	10	SD LOSS OF FIELD						Not adjustable
Low Battery Voltage	10	LOW BATTERY VOLTAGE	RDO-12 (lead 62)	10–12.5 V (12 V) 20–25 V (24 V)	12 V (12 V) 24 V (24 V)	0	10	
Low Coolant Level (see D14) (with LCL switch) **								—
Low Coolant Temperature (see D03) **								—
Low Coolant Temperature Shutdown ††	10	LOW COOLANT TEMP SHUTDOWN						Not adjustable
Low Fuel (Level or Pressure) Warning (see D02) **								—
Low Fuel Pressure Shutdown (see D09) (125RZG only)								—
(Low) Oil Pressure Shutdown	10	OIL PRESSURE SHUTDOWN	RDO-04 (lead 38)			30	5	Not adjustable
(Low) Oil Pressure Warning	10	OIL PRESSURE WARNING	RDO-07 (lead 41)			30		Not adjustable
Maintenance Due	10	MAINTENANCE DUE						Not adjustable
Master Not In Auto (Generator Set Switch)	10	MASTER NOT IN AUTO	RDO-09 (lead 80)					Not adjustable
Master Switch Error	10	MASTER SWITCH ERROR						Not adjustable

* All models, except Waukesha-powered models.

** NFPA applications

† Non-paralleling applications

†† DDC/MTU engine with MDEC/ADEC

‡ Waukesha-powered models

‡‡ FAA only

§ Paralleling applications

|| Denotes the default parameter range. Typically, ranges for the NiCad battery topology are slightly wider. For more details, refer to the battery charger operation manual.

Status Event or Fault	Refer to Menu	Digital Display	Relay Driver Output (RDO)	Range Setting	Default Selection	Inhibit Time Delay (sec.)	Time Delay (sec.)	User-Defined Settings
Master Switch to Off	10	MASTER SWITCH TO OFF						Not adjustable
Master Switch Open	10	MASTER SWITCH OPEN						Not adjustable
NFPA 110 Fault **	10	NFPA 110 FAULT	RDO-10 (lead 32)					Not adjustable
No Air Temperature Signal Warning ‡	10	NO AIR TEMP SIGNAL				30	4	Not adjustable
No Coolant Temperature Signal	10	NO COOL TEMP SIGNAL				30	4	Not adjustable
No Oil Pressure Signal	10	NO OIL PRESSURE SIGNAL				30	4	Not adjustable
No Oil Temperature Signal Warning ‡	10	NO OIL TEMP SIGNAL				30	4	Not adjustable
Output Enable	18			Fixed	Active			Not adjustable
Overcrank Shutdown	8, 10	OVER CRANK	RDO-02 (lead 12)	0-6 Cycles	3 Cycles			
Overcurrent	10	OVER CURRENT			110%		10	Not adjustable
Over Current VR (voltage restraint) Shutdown §	10	SD OVER CURRENT VR						Not adjustable
Overfrequency Shutdown	7, 10	OVER FREQUENCY	RDO-28	102%-140%	110% Std. 103% FAA		10	
Over Power Shutdown §	10	SD OVER POWER			102% Stdby 112% Prime			Not adjustable
Overspeed Shutdown	7, 10	OVER SPEED	RDO-01 (lead 39)	65-70 Hz (60 Hz) 55-70 Hz (50 Hz)	70 (60 Hz) 70 (50 Hz)		0.25	
Overvoltage Shutdown	7, 8, 10	OVER VOLTAGE	RDO-20 (lead 26)	105%-135% of nominal	115% 2-sec time delay† 135% 10-sec time delay§		2-10	
Password (see Access Code)								—
Pre Lube Relay ‡	10	PRE LUBE RELAY	RDO-26 ‡				4	Not adjustable
Remote Reset (see D16)								—
Remote Shutdown (see D15)								—
Reverse Power Shutdown §	10	SD REVERSE POWER						Not adjustable
Speed Sensor Fault	10	SPEED SENSOR FAULT	RDO-24					Not adjustable
Starting Aid (see Time Delay Starting Aid)								—
System Ready	10		RDO-17 (lead 60)					Not adjustable

* All models, except Waukesha-powered models.

† Non-paralleling applications

‡ Waukesha-powered models

§ Paralleling applications

|| Denotes the default parameter range. Typically, ranges for the NiCad battery topology are slightly wider. For more details, refer to the battery charger operation manual.

** NFPA applications

†† DDC/MTU engine with MDEC/ADEC

‡‡ FAA only

Status Event or Fault	Refer to Menu	Digital Display	Relay Driver Output (RDO)	Range Setting	Default Selection	Inhibit Time Delay (sec.)	Time Delay (sec.)	User-Defined Settings
Time Delay Engine Cooldown (TDEC)	8, 10	DELAY ENG COOLDOWN	RDO-16 (lead 70C)	00:00-10:00 min:sec	5:00			
Time Delay Engine Start (TDES)	8, 10	DELAY ENG START		00:00-5:00 min:sec	00:01			
Time Delay Starting Aid	8, 10			0-10 sec.				
Turbocharger Temperature Shutdown (1750/2000REOZMD)	10	TURBO TEMP SHUTDOWN				30		Not adjustable
Turbocharger Temperature Warning (1750/2000REOZMD)	10	TURBO TEMP WARNING				30		Not adjustable
Underfrequency	7, 10	UNDER FREQUENCY	RDO-29 ‡	80%-97%	97% FAA 90% † 80% §		10	
Undervoltage Shutdown	7, 8, 10	UNDER VOLTAGE	RDO-27	70%-95%	85% 10-sec time delay † 70% 30-sec time delay §		5-30	
Variable Speed Governor (VSG) (see A06)								—
VAR/PF Mode (see D17)								—
Voltage Lower (see D18)								—
Voltage Raise (see D19)								—
Weak Battery	10	WEAK BATTERY			60% of nominal		2	

* All models, except Waukesha-powered models.

† Non-paralleling applications

‡ Waukesha-powered models

§ Paralleling applications

|| Denotes the default parameter range. Typically, ranges for the NiCad battery topology are slightly wider. For more details, refer to the battery charger operation manual.

** NFPA applications

†† DDC/MTU engine with MDEC/ADEC

‡‡ FAA only

Notes

Appendix C Voltage Regulator Definitions and Adjustments

The following definitions and adjustment/setting specifications are intended for users planning to adjust the voltage regulator beyond the default settings in order to customize the alternator for a specific application.

This information is not intended to be a comprehensive explanation of all the terms mentioned. There are numerous documents available that define these terms more completely than described herein. Any user planning to change the generator set controller adjustment settings or to apply the generator set to these types of applications should understand these terms.

This appendix contains references to other sections of this manual. Please refer to these sections for further information and explanation.

Paralleling generator sets can be a complicated and dangerous exercise. Application programming must be performed by appropriately skilled and suitably-trained personnel.

Definitions

Underfrequency Unloading

Underfrequency unloading is a function used in the alternator excitation control system to improve the overall generator set system (engine and alternator) response. In particular, underfrequency unloading relates to large-block load applications. When applied to engine-driven alternators, large-block loads cause a subsequent transient torque load on the engine. This torque load can reduce the engine's speed below the normal operating point. Typically, the engine speed controller or governor will compensate for this by commanding an increase in fuel. If, however, the fuel system is inadequate to recover from a relatively large load, the speed may never recover. In these instances, other measures must be taken. This is where the underfrequency unloading occurs.

When the excitation control system detects a drop in the speed or electrical frequency below some predetermined point, the control system enters an unloading condition. This can be described as moving to a lower voltage regulation point. By reducing the output voltage of the alternator, the load on the generator set is reduced. This can be shown

mathematically by Ohm's law, which states that power is equal to the voltage squared divided by the impedance. As the voltage is reduced, the power delivered by the alternator decreases by a squared relationship. Since it is the power in the alternator that translates into engine torque, the engine load is also reduced.

By changing various parameters of this compensation technique, the controlling system can be tailored to match the performance capabilities of most engine and alternator combinations. The point at which the unloading begins to act or how much unloading occurs can be adjusted to impact maximum voltage droop, maximum speed droop, or time to recover. Some applications may not need unloading and, in these cases, set the unloading parameter to disable the function. These parameters are further described below. An example is provided to help clarify the relationship between these parameters.

Underfrequency Unload Slope

Underfrequency unload slope is the term used to describe the amount that the voltage is reduced, per-cycle-per-second or per-hertz (Hz), when in an underfrequency condition. The slope or schedule is sometimes called the volts-per-hertz slope. When the electrical frequency drops below the cut-in point (see below), the excitation control system temporarily reduces the regulated voltage to reduce the subsequent torque on the engine. The amount that the control system reduces voltage is defined as the product or multiplication of the slope and the amount of frequency or speed below the cut-in point. For every Hz below the cut-in point, the control system reduces the line-to-line voltage by an amount equal to the slope.

Because each engine responds differently to the various loads encountered, the slope may be adjusted to improve the system response. If, when large loads are applied to the generator set, the engine speed drops below the acceptable limit (as determined by the particular loads applied), the slope may need to be increased. Increasing the slope will cause the voltage to droop more during load applications, consequently reducing the load torque on the engine and allowing the speed to increase. If, however, the voltage drops below an acceptable lower limit (as determined by the particular loads connected to the generator set), a lower slope may work better. The underfrequency unloading function may be disabled by setting the slope to zero.

Frequency Setpoint or Cut-In Point

The point at which the underfrequency unloading begins to take effect is adjustable, allowing the system to be tailored for each application. Because the characteristics of the engine have the largest effect on the system's performance, the engine's response should determine the unloading point. The unloading setpoint is the frequency below which the excitation control will reduce the voltage so that the engine may begin to recover.

The cut-in point, or frequency setpoint, should be set 0.5–3.0 Hz lower than the normal steady-state band of operation. If the engine normally operates within a very narrow range of speeds close to the nominal, a setpoint of 0.5 to 1.0 Hz below nominal should be suitable. If the engine normally operates over a wide range of speeds, the setpoint may need to be 2.0–3.0 Hz from the nominal. The underfrequency unloading function can be eliminated by setting the cut-in point below the minimum expected operating frequency.

Example

A 90 kW load is applied to a 100 kW, 60 Hz generator set driven by a turbocharged diesel engine with an electrical control module (ECM). The speed drops 10% and takes 20 seconds to recover to at least 59.5 Hz. The voltage, meanwhile, drops from 480 to 460 and recovers to 480 within 15 seconds. Therefore, some underfrequency unloading should be provided. A good starting point would be a frequency setpoint or cut-in of 59 Hz. A slope of 15 volts per-cycle-per-second is appropriate as well. If after these adjustments the speed recovers very quickly, in about 5 seconds, but the voltage drops below 440 volts, the slope should be reduced to 12 volts per cycle. More adjusting may be required to get the most desirable compromise between speed and voltage.

Three-Phase Sensing

Three-phase sensing describes how the excitation control or voltage regulator determines the condition of the alternator output voltage. Early types of regulators sensed the voltage on just one phase of the alternator. Single-phase sensing is not uncommon today as most

alternators are designed to produce balanced, equal voltage on all three phases. If the loads applied to the generator set including no load are equal and balanced, the output voltage on each phase will be nearly equal.

However, in some applications, individual phases may have unequal or unbalanced loads. In these cases, the output voltages will not be equal on each phase. In general, the phase with the greatest load will have the lowest voltage while the phase with the least load will have the highest voltage. This is true regardless of the type of sensing used in the regulator system. A single-phase sensing excitation controller will keep the voltage of the sensed phase at the voltage adjustment value. A three-phase sensing system will average the three phases and hold the average to the adjustment setting. The average is the sum of the voltages of three phases divided by 3.

As stated above, three-phase sensing does not eliminate the unequal voltage phenomenon. Three-phase sensing balances the inequality of voltage between the phases to the desired value. In other words, if a system with unbalanced loads uses a single-phase control feedback, the voltage on the sensed phase would be at the setpoint while the other two phases would vary by their proportional loads. For example, if the sensed phase had rated load while the two other phases were only loaded at half the rated value, those two phases would have higher-than-rated voltage which may be undesirable. If a three-phase sensing feedback were utilized, the phase with rated load would be regulated to a voltage slightly below the rated voltage while the other two phases would be slightly above the rated voltage (but lower than in the previous case). The sum of the three, divided by 3, would be equal to the regulation setpoint.

In a single-phase system, line-to-line voltage is held equal to the line-to-line voltage adjust setting. In a three-phase system, the average of the three line-to-line voltage is regulated to the voltage adjust setting. In some cases, it may be desirable to keep one phase at a particular value. Modify the voltage adjust setting higher or lower accordingly for any unique requirements for the particular application. Each of the individual phase voltages is available in Menu 11, Voltage Regulator.

Reactive Droop

Reactive droop refers to another compensation technique used in excitation control systems. Reactive droop means that the generator set voltage droops with increasing reactive current. Although this sounds like an undesirable effect, it is quite beneficial in paralleling applications with multiple generator sets. Because the terminals of the generator set are connected to another generator set(s), the voltage at the terminals is not solely determined by either generator set's excitation. Rather, it is determined by the combination of the excitation level, the generated voltage, and the voltage drop across the armature impedance or armature reactance for each generator set.

Normally the generated voltage is higher than the voltage at the terminals because the generator set current causes a drop across the armature impedance. In a parallel application, the generated voltage of one generator set may be slightly higher than the generated voltage of another generator set. Differences in potential between the generator sets will cause current to flow into the lower voltage generator set and will also cause the generator sets to share the load current disproportionately. Both results are undesirable.

By introducing reactive droop, the reactive current can be better predicted and controlled. If the current is measured, the regulator/controller can adjust the excitation up or down accordingly, reducing excitation as more current is supplied or increasing excitation as the reactive current decreases. If all the parallel generator sets incorporate this type of compensation, the reactive current can be shared equally based on the proportional size of the generator sets. For an example, see below.

The stability and accuracy of this technique depends on several factors. Most important, the regulation point for each generator set must be equal. That is, each voltage adjust setting must be the equal to the other(s). This is a basic requirement prior to the actual paralleling connection. Also, the effects of the reactive current in each generator set must be compensated for individually, which requires an adjustable droop for each generator set. This adjustment happens to be the reactive droop adjust. The reactive droop adjust is quantified as the droop in operating voltage from the adjusted setting when full rated load with 0.8 power factor (PF) is applied. A droop setting of 4% voltage at full rated load is a recommended starting point. If the reactive current is not shared proportionately in each generator set, the respective droops may need adjustment. Adjust those generator sets that have proportionately higher current for more droop and those generator sets with lower reactive current for less droop.

If the reactive current is not stable in the system, adjust the droop lower in all generator sets.

As implied above, the reactive droop is not usually necessary in stand-alone applications. Therefore, some means of disabling the feature is provided. If the generator set will not be paralleled with other generator sets, the reactive droop feature should be disabled. A reactive droop setting of 0 will also effectively disable the reactive droop feature. It should be noted that reactive droop applies strictly to the reactive current or volt-ampere-reactive (VAR) loading. Primarily, the fueling or speed governing system controls the real current which contributes to watts loading.

The gain of the reactive droop function is determined by the voltage droop setting. For most applications, a droop of 3%–5% of rated voltage at rated load at 0.8 PF is adequate. Prior to actually connecting the generator sets in parallel, test the droop by applying full rated load at 0.8 PF. The system is operating correctly if this test shows a reduction in voltage equal to the voltage droop setting. If the available load is less than full load, the correct voltage droop should be proportional to the applied VAR load as a fraction of the rated VAR output for the generator set. For instance, a 480-volt generator set with a voltage droop setting of 4% should drop 19.2 volts with full rated (0.8 PF) load applied (480×0.04) or 9.6 volts with half the rated load applied ($480 \times 0.04 / 2$).

When a generator set will be connected in parallel with the utility, VAR or PF control should be ENABLED. If there are multiple generator sets in parallel as well, then reactive droop should be ENABLED also.

Example

Two 100 kilowatt (kW) generator sets are paralleled to provide 150 kW of power at 0.8 PF and wired for a 277/480-volt wye system.

Total kVA load:

$$\text{kVA} = \text{kW} / \text{PF}$$

$$187.5 = 150 / 0.8$$

KVAR load:

$$\text{kVAR} = \text{kVA} * \sin (\text{acos} [\text{PF}])$$

$$112.5 = 187.5 * 0.6$$

Line current:

$$I = (\text{VA} / 3) / V_{L-N}$$

$$226 \text{ amps} = (187500 / 3) / 277$$

Reactive current:

$$I = (\text{VAR} / 3) / V_{L-N}$$

$$135 \text{ amps} = (112500 / 3) / 277$$

Where: acos is arccosine or inverse cosine
 W is Watt
 L-N is line-to-neutral
 PF is power factor
 VA is volt-ampere
 k is kilo (= 1000)

Therefore, each generator set in this case should carry 113 amps per phase or half the 226 calculated line amps. The 113 amps includes 67.5 amps of reactive current, half of the calculated reactive current of 135 amps. The reactive droop should be adjusted until each generator set carries equal reactive current. The load sharing control should be adjusted so that real current and/or watts are shared equally as well.

If one generator set is larger than the other, it should be adjusted to carry proportionate current. For this example, if a 150 kW generator set is paralleled to a 75 kW generator set, the larger generator set would carry 90 amps reactive ($135 * 2 / 3$) and the other would carry 45 amps reactive ($135 * 1 / 3$). Adjust the reactive droop based on the ratio of the actual measured currents, not the calculated values.

VAR Control

VAR control is analogous to the reactive droop function described above. It differs in that it applies to utility paralleling applications. Because the utility represents a nearly infinite bus, the voltage at the load terminals is not controlled at all by the generator set, and it is impossible to compare the ratio of the generator set current to the utility based on its rated output. In this situation, the excitation control changes from voltage feedback to VAR feedback. More specifically, the excitation is controlled to maintain a certain VAR output rather than a voltage output. This is called VAR control and again is used only in utility paralleling applications.

The VAR adjust can be set to any value within the generator set's rated capability. Because the VARs cause heating in the armature, any value beyond the generator set's rating could damage the alternator. In most cases, the generator set will be adjusted to generate VAR (lagging PF) but could absorb VARs (leading PF) as well. However, the VAR setting is maintained regardless of the relative PF. If the particular load requires more VARs than the generator set setting, the excess is derived from the utility bus.

The term *rated VARs* is a bit obscure. In essence, it is a value derived from the rated kW of the generator set. For a typical standby rating, the full load of the generator set is defined to have 0.8 PF. This means that the kW load is eight-tenths of the VA load. As described earlier, the PF for a linear load may be calculated as the cosine of the angle between voltage and current. This relationship is based on the power triangle. Using this power triangle concept, it can be shown that the reactive power for a linear load is equal to the sine of the power angle. Then, using these trigonometric functions, it can be shown that for a PF of 0.8, the VARs are related similarly to the VA by a factor of 0.6. More explicitly, the power angle is equal to the inverse cosine (arccosine) of the PF. For a PF of 0.8, the power angle is 36.9 degrees (0.2 radians). The sine of this angle, sine (36.9 degrees) is 0.6. This is the factor for calculating rated VARs from the rated VA. The ratio of these two factors is 0.75 ($0.6 / 0.8$), which can be used to calculate rated VARs directly from the rated kW; rated VARs equals rated watts * 0.75.

When a generator set will be connected in parallel with the utility, VAR or PF control should be ENABLED. If multiple generator sets are in parallel as well, then reactive droop should be ENABLED also. Additionally, note that VAR control should be used only when the generator set is connected in parallel with the utility. Parallel connection with the utility requires the logical indication that the circuit breakers tying the generator set bus to the utility bus are closed. This indication is made by use of the programmable digital input for VAR/PF mode. If this input function is activated, the excitation control changes to the selected VAR or PF control. If the logical indicator is not present and the VAR or PF control is not enabled, the control will not switch to VAR or PF control. Because the active state for the digital input is a HI or open connection, the default for the digital input (VAR/PF Mode) is DISABLED (displays ENABLED NO). If the input is ENABLED by the user, it should be held low by a contact or jumper until the actual closing of the connecting circuit breaker(s). The proper control method, VAR or PF, must be ENABLED within the regulator's configuration menu.

Power Factor Control

PF control is much like the VAR control above. PF control is used only when the generator set is paralleled to the utility grid. The difference is that the PF of the generator set current is held constant. The setting for the PF adjust determines the relationship of the current and voltage from the generator set. The PF is a term that defines the ratio of real watts to the volt-ampere (VA) product. For linear loads, a trigonometric relationship can describe the PF. The PF equals the cosine of the angle between the current and voltage. PF is further defined

as leading or lagging. That is to say, if the current lags the voltage (i.e., is later in time), the PF is lagging; if the current leads the voltage (i.e., is earlier in time), the PF is leading. Inductive loads have lagging PF while capacitive loads have leading PF. The current in a purely resistive load is in phase with the voltage (not leading or lagging) and the PF is 1.0 (cos. [0]).

Set the PF adjust according to the requirements of the application. When a generator set will be connected in parallel with the utility, VAR or PF control should be ENABLED. If there are multiple generator sets in parallel as well, then reactive droop should be ENABLED also. Additionally, note that PF control should be used only while the generator set is connected in parallel with the utility. Parallel connection with the utility requires the logical indication that the circuit breakers tying the generator set bus to the utility bus are closed. This indication is made by use of the programmable digital input for VAR/PF mode. If this input function is activated, the excitation control changes to the selected VAR or PF control. If the logical indicator is not present and the VAR or PF control is not enabled, the control will not switch to VAR or PF control. Because the active state for the digital input is a HI or open connection, the default for the digital input (VAR/PF mode) is DISABLED (displays ENABLED NO). If the input is ENABLED by the user, it should be held low by a contact or jumper until the actual closing of the connecting circuit breaker(s). The proper control method, VAR or PF must be ENABLED within the regulator's configuration menu.

Adjustment and Setting Specifications

Voltage Adjust

The voltage adjust is entered as the rated or otherwise desired line-to-line voltage. The average of the line-to-line voltages is then regulated to the corresponding value as previously described. The setting may be as fine as tenths of volts. The voltage adjust defaults to the rated system voltage whenever the system voltage is changed. The voltage adjust may be set to any value within $\pm 10\%$ of the system voltage. The upper limit is $\pm 10\%$ above the system voltage and the lower limit is $\pm 10\%$ below the system voltage. If a value beyond these limits is entered, a RANGE ERROR message will be displayed.

As a reference, the present voltage adjust setting is displayed as well as the average value of the line-to-line voltages. The individual line-to-line voltages are also displayed on the subsequent menu screens. This allows the user to monitor any individual phase, if desired.

The voltage adjust setting may be changed by means other than the menu including user-defined digital input or remote communications. If voltage adjustment occurs, the new value will be displayed accordingly in the voltage adjust menu.

Underfrequency Unload Enable

The underfrequency unload enable menu is used to turn the underfrequency unload on or off. A YES entry will turn the feature on and the display will show ENABLED YES. A NO entry will turn the feature off and the display will show ENABLED NO. The underfrequency unload defaults to an enabled (ON) condition.

Frequency Setpoint

The frequency setpoint is the cut-in point for underfrequency unloading. At any operating frequency below the frequency setpoint, the output voltage will be reduced. The frequency may be entered with resolution to tenths of a Hz. The range of acceptable entries is 30 to 70 Hz. Any entry beyond these limits causes a RANGE ERROR display and the setting will not change. The default value is one cycle-per-second (or two for non-ECM engines) below the normal system frequency. The frequency setpoint changes to the default value if the system frequency changes. A setting of 30 Hz essentially disables the underfrequency unload feature because most engines do not normally drop to speeds this low, even during load applications.

Underfrequency Unload Slope

The slope determines how much voltage is reduced during an unloading condition. The line-to-line voltage is regulated to a value less than the voltage adjust setting by this amount for every cycle below the frequency setpoint. The voltage may be entered with resolution as fine as one-tenth of one volt. The default value is 2.0 volts per-cycle-per-second. A zero entry for the slope in effect turns the underfrequency unload feature off.

Reactive Droop Enable

This menu allows the user to enable the reactive droop feature. A YES entry turns the feature on and the display shows ENABLED YES. A NO entry turns the feature off and the display shows ENABLED NO. Reactive droop is intended to be used in a generator set-to-generator set paralleling application.

Voltage Droop

The amount of reactive droop is entered here. The droop is entered as a percentage of system voltage when a fully rated load at 0.8 PF is applied. The entry may be made with resolution as fine as one-tenth of one volt. This entry determines how much the voltage will droop when the alternator provides reactive current. The actual amount the voltage changes is equal to the voltage droop setting times the VAR load as a fraction of the rated VARs (at 0.8 PF). If the generator set were providing full rated load (at 0.8 PF), the expected voltage change would equal the voltage droop setting as a percentage of system voltage. A voltage droop setting of zero in effect disables the reactive droop feature. The default value is 4% droop at full rated load at 0.8 PF.

The present voltage droop setting is displayed for reference. The display may change if this value is changed via remote communication.

VAR Control Enable

In order for the VAR control function to operate, it must be enabled. Entering YES at this menu will turn the feature on. Because the function is designed to operate while the generator set is in parallel with the utility, VAR control also requires the proper indication that all tying circuit breakers are closed. This is done through the user-programmable digital inputs.

Because VAR control cannot be enabled at the same time that PF control is enabled, turning VAR control on (ENABLED) when PF control is enabled turns the PF control off (DISABLED).

KVAR Adjust

Using the kVAR adjust sets the desired operating value for the generator set's reactive load when the generator set operates in a utility paralleling application. The desired generator set load is entered directly as kVARs. The value entered may be as low as zero or as high as the rated value (rated kW x 0.75). Any entry beyond the rated value will not be accepted, and a RANGE ERROR message will be displayed.

The default value for kVAR adjust is zero. Each time the system's rated kW is changed, the kVAR adjust will revert to zero. The displayed kVAR setting may change if the kVAR setting is changed via other inputs.

Generating/Absorbing

While operating in the VAR control mode, the reactive load on the generator set may be specified to be out of GENERATING or into ABSORBING the generator set. Specifying the VAR type or direction is done through the GENERATING/ABSORBING menu. Because the normal flow of reactive current is out of the generator set, the default value is GENERATING. If ABSORBING is desired, a NO entry at this menu will change the control mode to ABSORBING. When ABSORBING is selected, another NO entry will revert the control mode back to GENERATING. It is assumed that this mode will not be changed when the generator set is running. An attempt to change the mode while running will return a RANGE ERROR message. The generator set will need to be shut down in order to change this setting.

PF Adjust

Use the PF adjust to set the desired operating relationship for the generator set's output voltage and current when the generator set is connected in parallel with the utility. The excitation is regulated to maintain a PF equal to the entered value. The value entered may be as low as 0.7 for leading PFs or as low as 0.6 for lagging PFs. Any entries below these limits will cause a RANGE ERROR message to display.

The upper limit for PF adjust is 1.0 and the default value is 0.8 lagging. Each time the system's rated kW is changed, the PF adjust will revert to this default value. The PF adjust display setting may change if the PF adjust is changed via other inputs.

Lagging/Leading

It is possible to select either a leading or lagging PF for utility parallel applications. The selected mode is displayed. A NO entry switches the controller to use the other reference. Because the most common mode of operation will be with a lagging PF, LAGGING is the default value. Because this mode should not be changed while the generator set is running, attempting to change this mode during operation will return a RANGE ERROR message. Always shut down the generator set to change the lagging/leading mode setting.

Appendix D Alternator Protection

The 550 controller has built-in thermal protection for the alternator. This feature functions similarly to a thermal circuit breaker. When the output current exceeds the nominal rating for a short period of time the condition causes the fault shutdown. The amount of time at which current is over the rating is inversely related to the amount of current above the nominal rating. In other words, the higher the current, the shorter the acceptable time.

The current and time limits are defined by actual test data and are maintained in the personality parameter file. Although the equation for detecting a fault is proprietary, some of the important limits are shown below for informational purposes.

Rated Current	Time Delay
200%	40 seconds
300%	10 seconds
425%	5 seconds
950%	1 second

Notes

Appendix E Inputs and System Events by Application

The controller inputs and system events are typically driven by the engine manufacturer's ECM. NFPA 110 guidelines provide specific requirements that all controllers must have for compliance. While the controller displays all NFPA 110 required data, some

engine ECMs provide additional items that the controller will display. The following table illustrates the available alternator and engine outputs for monitoring and factory reserved connections.

Controller Inputs and System Events	NFPA 110 Applications	Paralleling Applications	DD/MTU Engines with MDEC/ADEC	Waukesha Engines	125RZG
AC Sensing Loss Warning					
Air Damper Control (if engine equipped)	X				
Air Damper Indicator Shutdown (see D20) (if engine equipped)	X				
Air/Fuel Module Engine Start Delay				X	
Air/Fuel Module Remote Start				X	
Air/Fuel Module Shutdown (see D11)				X	
Alternator Protection Shutdown					
Analog Aux. Input 0 Local Battery VDC					
Analog Aux. Inputs A01-A07 (Warning or Shutdown)					
Analog Aux. Input A01 Coolant Temperature (non-ECM)					
Analog Aux. Input A02 Oil Pressure (non-ECM)					
Analog Aux. Input A03 Intake Air Temperature				X	
Analog Aux. Input A04 Fuel Level					
Analog Aux. Input A04 Oil Temperature Warning				X	
Analog Aux. Input A06 VSG (Volvo, GM, Doosan only)					
Analog Aux. Input A07 Analog Volt Adjust					
Battery Charger Communication Error					
Battery Charger Fault Warning (see D01)	X				
Battery Charger Value Mismatch Error					
Battle Switch Warning					
Block Heater Control			X		
Breaker Closed Warning (see D05)		X			
Breaker Trip Warning		X			
Common Protective Relay Warning		X			
Critical Overvoltage Shutdown					
Cyclic Cranking					
Defined Common Faults (Warning or Shutdown)					
Detonation Shutdown (see D13)				X	
Detonation Warning (see D12)				X	
Digital Aux. Inputs D01-D21 (Warning or Shutdown)					
Digital Aux. Input D01 Battery Charger Fault Warning	X				
Digital Aux. Input D02 Low Fuel (Level or Pressure) Warning	X				
Digital Aux. Input D03 Low Coolant Temperature Warning	X				
Digital Aux. Input D04 Field Overvoltage Shutdown					
Digital Aux. Input D05 Breaker Closed Warning		X			
Digital Aux. Input D06 Enable Synch		X			
Digital Aux. Input D09 Low Fuel Pressure Shutdown					X
Digital Aux. Input D11 Air/Fuel Module (AFM) Shutdown				X	
Digital Aux. Input D12 Detonation Warning				X	
Digital Aux. Input D13 Detonation Shutdown				X	
Digital Aux. Input D13 Knock Shutdown				X	
Digital Aux. Input D14 Low Coolant Level Warning	X				

Controller Inputs and System Events	NFPA 110 Applications	Paralleling Applications	DD/MTU Engines with MDEC/ADEC	Waukesha Engines	125RZG
Digital Aux. Input D15 Remote Shutdown					
Digital Aux. Input D16 Remote Reset					
Digital Aux. Input D17 VAR/PF mode					
Digital Aux. Input D18 Voltage Lower					
Digital Aux. Input D19 Voltage Raise					
Digital Aux. Input D20 Air Damper Indicator Shutdown (if engine equipped)	X				
Digital Aux. Input D21 Idle (Speed) Mode Warning					
ECM Yellow Alarm Warning			X		
ECM Red Alarm Shutdown			X		
EEPROM Write Failure Shutdown					
Emergency Stop Shutdown					
Engine Derate Active					
(Engine) J1939 CAN Engine Shutdown (ECM only)					
Engine Stalled (ECM only)					
EPS (Emergency Power System) Supplying Load Warning					
Field Overvoltage Shutdown (M4, M5, M7, M10 alternator only) (see D04)					
Fuel Level (units with subbase fuel tanks) (see A04)					
Fuel Valve Relay				X	
Generator Set Running					
Ground Fault Detected Warning					
High Battery Voltage Warning					
High Coolant Temperature Shutdown					
High Coolant Temperature Warning					
High Oil Temperature Shutdown					
High Oil Temperature Warning			X	X	
Idle Speed Mode Function Warning					
Intake Air Temperature Shutdown			X		
Intake Air Temperature Warning			X		
Intake Air Temperature Warning (see A03)				X	
Internal Fault Shutdown					
Knock Shutdown (see D13)				X	
Load Shed kW Overload Warning (FAA only)					
Load Shed Over Temperature (activated by HCT shutdown)			X		
Load Shed Underfrequency Warning					
Locked Rotor Shutdown					
Loss of ECM Communication Shutdown (ECM engines only)					
Loss of Field Shutdown (Reverse VARs)		X			
Low Battery Voltage Warning					
Low Coolant Level Shutdown					
Low Coolant Level Warning (see D14)	X				
Low Coolant Temperature Shutdown			X		
Low Coolant Temperature Warning (see D03)	X				
Low Fuel (Level or Pressure) Warning, (see D02)	X				
Low Fuel (Pressure) Shutdown (see D09)					X
(Low) Oil Pressure Shutdown					
(Low) Oil Pressure Warning					
Maintenance Due					
Master Not In Auto (Generator Set Switch)					
Master Switch Error Shutdown					

Controller Inputs and System Events	NFPA 110 Applications	Paralleling Applications	DD/MTU Engines with MDEC/ADEC	Waukesha Engines	125RZG
Master Switch to Off Shutdown					
Master Switch Open Shutdown					
NFPA 110 Fault (Warning or Shutdown)	X				
No Air Temperature Signal Warning				X	
No Coolant Temperature Signal Shutdown					
No Oil Pressure Signal Shutdown					
No Oil Temperature Signal Warning				X	
Overcrank Shutdown					
Over Current Voltage Restraint Shutdown		X			
Over Current Warning					
Over Frequency Shutdown					
Over Power Shutdown		X			
Over Speed Shutdown					
Overvoltage Shutdown					
Pre Lube Relay				X	
Remote Reset (see D16)					
Remote Shutdown (see D15)					
Synch Enable (see D06)		X			
VAR/PF Mode (see D17)					
Voltage Lower (see D18)					
Voltage Raise (see D19)					
Reverse Power Shutdown		X			
Speed Sensor Fault Warning					
System Ready					
Time Delay Engine Cooldown (TDEC)					
Time Delay Engine Start (TDES)					
Time Delay Starting Aid					
Underfrequency Shutdown					
Undervoltage Shutdown					
Variable Speed Governor (VSG) (see A06)					
VAR/PF Mode (see D17)					
Voltage Lower (see D18)					
Voltage Raise (see D19)					
Weak Battery Warning					

Notes

Appendix F Controller Displays from the Engine ECM

The controller display showing engine information is dependent upon the engine manufacturer and the corresponding Engine Control Module (ECM). The following list indicates what engine displays are available by the engine manufacturer. This information is subject to change by the engine manufacturer.

Some engines do not have an ECM and in some cases the ECM information is not available as a controller display. In these situations, critical information like oil pressure and coolant temperature are displayed by the controller using independent engine sensors not used by the ECM.

Controller Displays as Provided by the Engine ECM (availability subject to change by the engine manufacturer)						
Display	GM/PSI	Doosan	John Deere (JDEC)	Volvo (EMS 2)	Volvo (EDC III)	DD/MTU (ADEC)
Ambient temperature		X				
Charge air pressure	X	X		X	X	X
Charge air temperature	X	X	X	X	X	
Coolant level				X	X	X
Coolant pressure				X	X	
Coolant temperature	X	X	X	X	X	X
Crankcase pressure				X	X	
ECM battery voltage	X	X				X
ECM fault codes	X	X	X	X	X	X
ECM serial number						X
Engine model number			X			X
Engine serial number			X			X
Engine speed	X	X	X	X	X	X
Fuel pressure				X	X	
Fuel rate	X	X	X	X	X	X
Fuel temperature			X	X	X	X
Oil level					X	
Oil pressure	X	X	X	X	X	X
Oil temperature				X	X	X
Trip fuel				X	X	X

Note: 40-60REOZK (Kohler KDI engines) do not have an ECM. REOZMD/ROZMC (Mitsubishi engines) have an ECM but do not send signals to the Decision-Maker® 550 controller.

Notes

Appendix G DEC 550 Controller Fault Displays

The controller fault display showing engine information is dependent upon the engine manufacturer and the corresponding Engine Control Module (ECM). The following list indicates what engine fault displays are available by the engine manufacturer as well as components added by the generator set manufacturer. This information is subject to change.

Some engines do not have an ECM and in some cases the ECM information is not available as a controller fault display. In these situations, critical information like oil pressure and coolant temperature faults are displayed by the controller using independent engine sensors not used by the engine ECM.

This chart is intended to be a guide for finding the corresponding component sensor based on the controller fault display since many of the sensors vary depending upon engine manufacturer. This information should be used in conjunction with Service Bulletin SB-616 as model specific information is available in this document including sensor lead identification.

In the table, where the word *Engine* is shown in italics, this is an indication that the sensor is provided by the engine manufacturer and component location, troubleshooting, and testing information would be found in the engine service literature.

Note: REOZMD/ROZMC (Mitsubishi engines) have an ECM but do not send signals to the Decision-Maker® 550 controller.

(1) All models use temperature sensor at lead 35A except: 40/50REOZJE which has an engine manufacturer-supplied temperature sensor. See SB-616 for lead nos./colors of the engine temperature sensor.

(2) The unit also incorporates a magnetic pickup at the flywheel with leads connected to terminals 5 and 6 on the flo-tech speed control (governor).

(3) Governor magnetic pickup leads are black/yellow/green leads to P36 connector, then black/white leads to governor on junction box, and then black/red to DEC550 controller.

While the table identifies the respective sensor as the trigger to the fault display, the actual cause of the fault must be investigated and corrected as needed. Also, keep in mind that if the sensor is determined to be the source of the fault display, the associated electrical connectors, terminals, and wiring must be examined as well as the sensor.

Display	Engine Manufacturer					
	GM/PSI	Doosan	John Deere (JDEC)	Volvo (EMS II)	DD/MTU (ADEC)	Mitsubishi
Warnings						
Fuel leak alarm	Not used		Fuel leak alarm at fuel tank (lead 64)			
High battery voltage warning	DEC 550 controller logic					
High coolant temp warning	<i>Engine</i> temperature sensor, see SB-616 for lead nos./colors					
High oil temp warning	Not used				<i>Engine</i> temp. sensor	Not used
Low battery voltage	DEC 550 controller logic					
Low coolant temperature	Temperature sensor at lead 35A		(1)	Temperature sensor at lead 35A	<i>Engine</i> temp. sensor, see SB-616 for lead nos./colors	Temp. sensor at lead 35A
Low fuel (pressure) level warning	Low fuel level at fuel tank (lead 63 or 63C)					
Low oil pressure warning	<i>Engine</i> pressure sensor, see SB-616 for lead nos./colors					
No oil temperature signal	Not used		DEC 550 controller logic			Not used
Speed sensor fault	DEC 550 controller logic					
Turbocharger temperature warning	Not used					<i>Engine</i> temp. sensor on 1750/2000REOZMD
Weak battery	DEC 550 controller logic					
Shutdowns						
Alternator protection shutdown	DEC 550 controller logic					
Critical overvoltage shutdown	DEC 550 controller logic					
Emergency stop	Local and/or remote emergency stop switch circuit open (leads 1 and 1A)					
Engine J1939 CAN loss of comm. shutdown	DEC 550 controller logic					Not used
Engine stalled	See Overspeed shutdown					
Field overvoltage (350-2000 kW only)	Not used	DEC 550 controller logic				
High coolant temperature shutdown	<i>Engine</i> temperature sensor, see SB-616 for lead nos./colors					
High oil temp shutdown	Not used			<i>Engine</i> temperature sensor		Not used
Intake air temperature shutdown	Not used				<i>Engine</i> temp. sensor	Not used
Locked rotor	See Overspeed shutdown					
Loss of ECM communication	DEC 550 controller logic including the CAN communications port (the associated hardware and software) on the ECM and the CAN bus cabling between the devices.					Not used
Loss of field (Reverse VARs) (Paralleling applications only)	DEC 550 controller logic					
Low coolant level shutdown	Low water level sender at radiator (lead 31A)					
Low coolant temperature	Not used				<i>Engine</i> temp. sensor	Not used
Low fuel (pressure) level shutdown	Sensor at lead 65 (125REZG)	Not used				
Low oil pressure shutdown	<i>Engine</i> pressure sensor, see SB-616 for lead nos./colors					
No coolant signal temperature signal	DEC 550 controller logic					Not used
No oil pressure signal	DEC 550 controller logic					Not used
Overcrank	DEC 550 controller logic					
Overcurrent VR shutdown (Paralleling applications only)	DEC 550 controller logic					
Overfrequency shutdown	DEC 550 controller logic					
Overpower shutdown (Paralleling applications only)	DEC 550 controller logic					
Overspeed shutdown (DTC-16)	<i>Engine</i> overcrank sensor at crankshaft with light green/red, white/purple, and purple/white leads	<i>Engine</i> crank sensor with purple/white & white/purple leads (2)	<i>Engine</i> crank position sensor with purple/gray leads	<i>Engine</i> flywheel sensor with red/blue lead	<i>Engine</i> Camshaft speed sensor (B1) and Crankshaft Speed Sensor (B13) typically with white leads	Governor magnetic pickup at engine flywheel (3)
Overvoltage shutdown	DEC 550 controller logic					
Reverse power shutdown (Paralleling applications only)	DEC 550 controller logic					
Underfrequency shutdown	DEC 550 controller logic					
Undervoltage shutdown	DEC 550 controller logic					

TP-6200 7/18n

Original Instructions (English)

© 2006, 2008, 2009, 2011, 2012, 2015, 2017, 2018 by Kohler Co. All rights reserved.

KOHLER®

KOHLER CO., Kohler, Wisconsin 53044
Phone 920-457-4441, Fax 920-459-1646
For the nearest sales/service outlet in the
US and Canada, phone 1-800-544-2444
KOHLERPower.com